

Les solutions encastrées 2016
Lavabo, douche et bain



Ce guide vous permet de prescrire et chiffrer
nos solutions encastrées en toute simplicité



UNIDOMO®

Web: www.unidomo.de

Telefon: 04621- 30 60 89 0

Mail: info@unidomo.com

Öffnungszeiten: Mo.-Fr. 8:00-17:00 Uhr

VIESMANN

Buderus

 **Vaillant**

WOLF

 **JUNKERS**  **BOSCH**



 **remeha**

 **DAIKIN**

ROTEX
a member of DAIKIN group



-  Individuelle Beratung
-  Kostenloser Versand
-  Hochwertige Produkte

-  Komplettpakete
-  Über 15 Jahre Erfahrung
-  Markenhersteller

Sommaire

Page 3	Les avantages d'une solution encastrée
Page 4	Caractéristiques de l'iBox
Page 7	Les corps d'encastrement et sets de finition
Page 8	Caractéristiques de l'iControl
Page 10	Les solutions pour le lavabo
Page 14	Les solutions pour la douche
Page 55	Les solutions ShowerSelect pour la douche
Page 65	Les solutions pour la baignoire

La brochure «Les solutions encastrées 2016» annule tout autre document précédent du même nom.

Hansgrohe Sarl ne pratique pas la vente directe aux particuliers.

Les prix publics 2016 de cette brochure s'entendent en Euros HT et sont donnés à titre indicatifs et sous réserve d'une éventuelle hausse en cours d'année.

Pratique et esthétique La solution encastrée !!



- Gain de place
- Facile à nettoyer
- Esthétique parfaite
- Nombreux choix de design

Un grand choix de sets de finition pour chacune des fonctions :

Différents styles...
Différentes finitions...



- Aucune tuyauterie apparente
- Des possibilités techniques infinies (douche de tête, douches latérales, douchette à main)



iBox® universal, 1 seul corps d'encastrement pour toutes les solutions encastrée

Le corps d'encastrement de toutes les solutions.

- 1 corps encastré pour 16 solutions différentes
- 1 corps encastré pour toutes les lignes Hansgrohe et Axor
- 1 corps encastré qui s'adapte à tous les systèmes d'installation
- 1 seul et unique corps encastré à stocker



**iBox
Universal**
10 GARANTIE
ANS

Les différentes possibilités d'encastrement

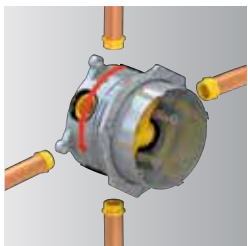
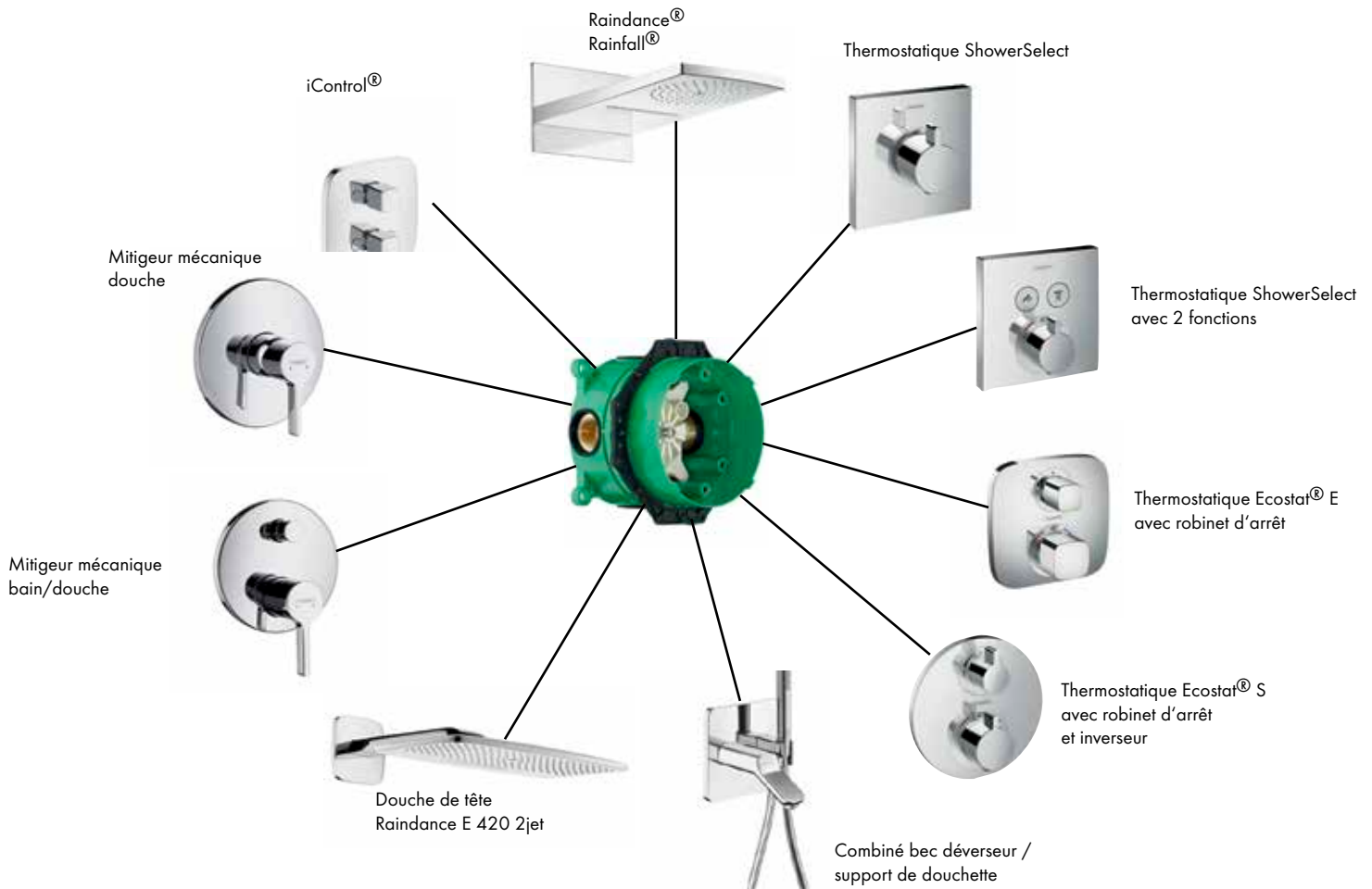

Installation symétrique
Tous les raccords sont identiques.

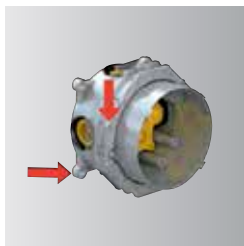

Diverses possibilités d'installation
Offre des alternatives de montage universelles.

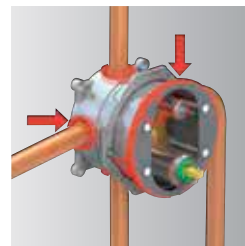

Étanchéité totale
Grâce aux joints en caoutchouc totalement hermétiques.

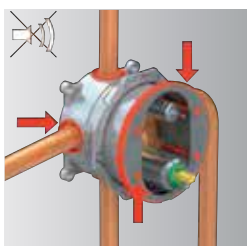

Insonorisé et anti-vibrations

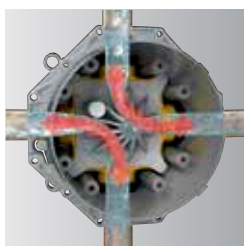

Rinçage simplifié
Bloc de rinçage inclus.

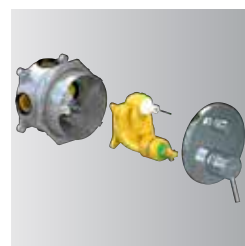

Sûr et économique
Permet l'installation du set de finition au dernier moment et évite ainsi le frais de stockage.

Caractéristiques du corps d'encastrement iBox



- Pas de sens de montage
- Profondeur de montage réduite : **80 mm (cote mini 58 mm)**

⇒ S'encastre dans la plupart des cloisons.
(voir rosace de compensation)

Universel !!!

⇒ Pas de confusion possible, référence unique, prix unique

Comprend 3 réductions $\frac{3}{4}$ / $\frac{1}{2}$ (20/27 → 15/21) et 1 bouchon.

Livré avec rosace de fixation.



Adaptabilité de la fixation de l'iBox selon l'épaisseur de l'habillage

Montage sans rosace

Rosace de fixation amovible

Rosaces de compensation en option pour l'iBox



Rosace de compensation permettant l'encastrement dans un mur de 58 mm.
Compensation max. : 22 mm

- Rosace Ø 170 mm Réf. 13596000 - 43,00 €
- Rosace Ø 152 mm Réf. 13597000 - 43,00 €
- Rosace PuraVida 157 x 157 mm Réf. 15597000 - 45,00 €
- Rosace Carrée 172 x 172 mm Réf. 97407000 - 39,50 €
- Rosace SoftCube 172 x 172 mm Réf. 98860000 - 51,00 €

L'iBox permet de corriger le montage en cas d'inversion entre un raccordement eau chaude et eau froide

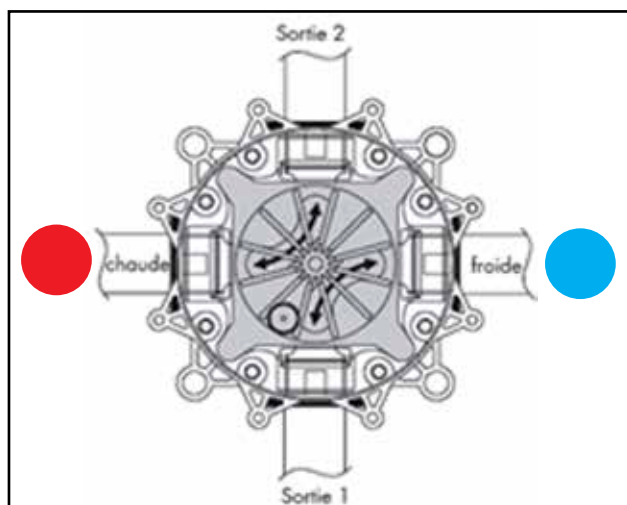

Situation en cas de montage correcte.

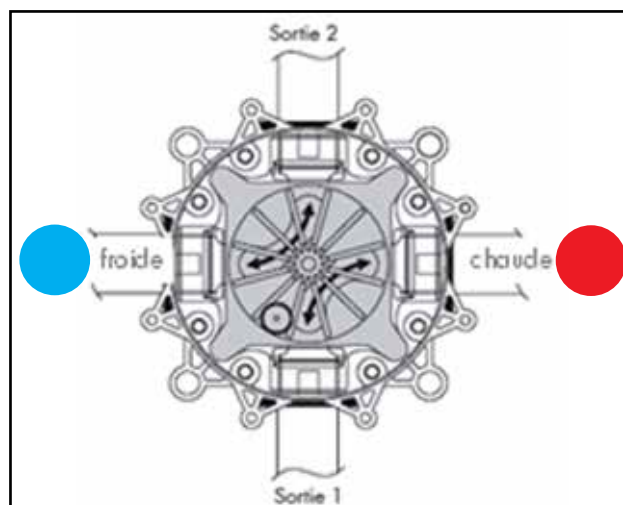

Situation en cas d'inversion entre raccord eau froide et eau chaude.

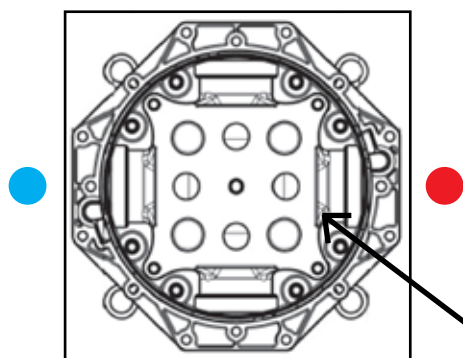

Bloc fonctionnel du set de finition à inverser

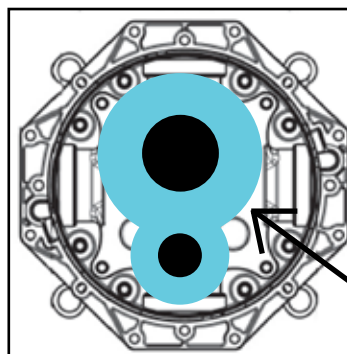
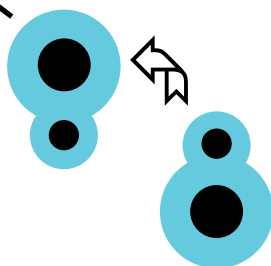

Rosace inversée (version spéciale, voir dans le catalogue interactif des pièces détachées)

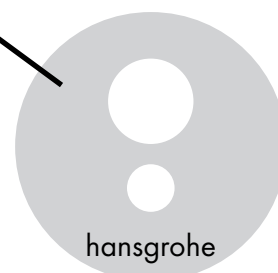

Corps d'encastrement et sets de finition

Corps d'encastrement

Sets de finition



Robinet d'arrêt :

- Existe en 1/2 et 3/4

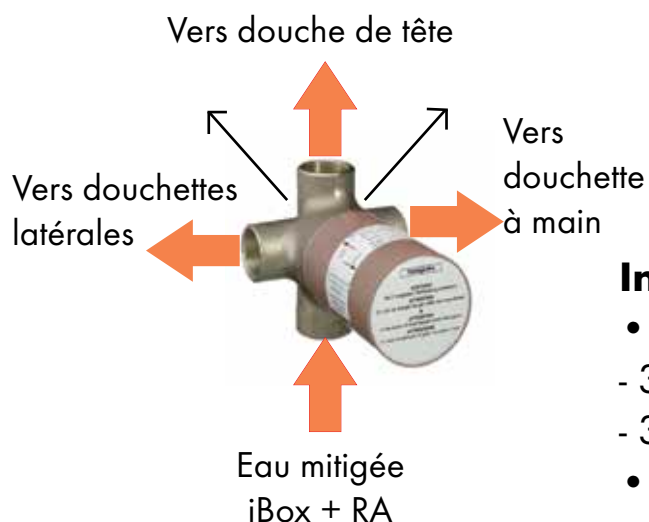

Inverseur Quattro

- Inverseur 6 fonctions :
 - 3 voies séparées
 - 3 positions à 2 voies simultanées
- Pas de fonction robinet d'arrêt

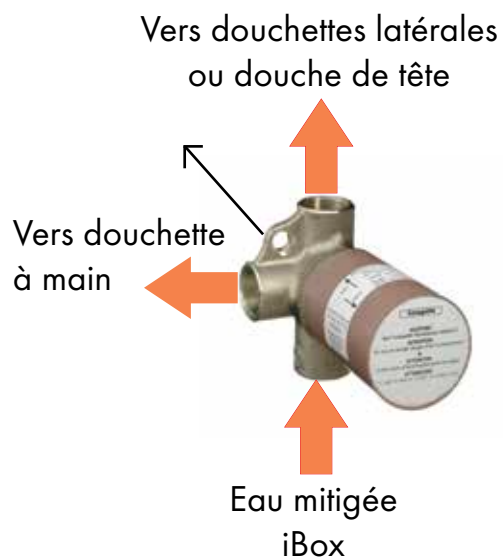

Inverseur Trio / Stop

- Robinet d'arrêt
- Inverseur 3 fonctions :
 - 2 voies séparées
 - 1 voie simultanée



iControl, Simplifiez vos installation encastrées

Caractéristiques :

- 1 entrée, 3 sorties
- Montage sur iBox 01800180
- 3 fonctions séparément ou simultanément

Avantages :

- Compatible haut débit
- Facilite la pose (gain de temps) et l'utilisation
- Pas d'erreur de commande grâce à l'utilisation d'un seul corps d'encastrement
- Remplace un robinet d'arrêt et un inverseur 3 fonctions
- Design universel

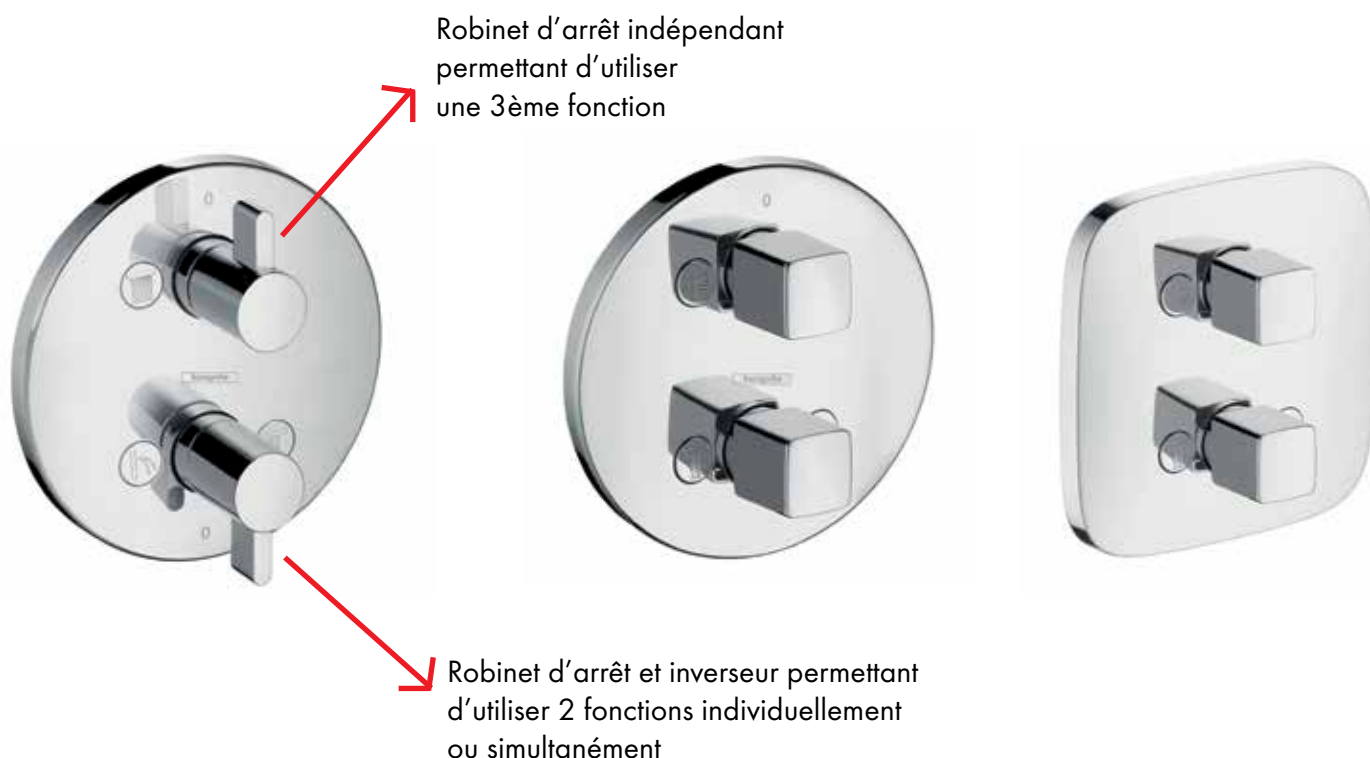

iControl S
Référence : 15955000
PPHT : 415 €

iControl E
Référence : 31958000
PPHT : 358 €

iControl SoftCube
Référence : 15777000
PPHT : 410 €

Les solutions pour le lavabo





Corps encastré Set de finition :
espacement de 150 mm



① Logis 195 mm
hansgrohe



② Talis 165 mm
hansgrohe



③ Talis S 165 mm
hansgrohe



④ Talis E 165 mm
hansgrohe



⑤ Metris 165 mm
hansgrohe



⑥ Metris S 165 mm
hansgrohe



⑦ PuraVida 165 mm
hansgrohe



⑧ Axor Bouroullec 200 mm
AXOR®



⑨ Axor Citterio E
220 mm avec plaque
AXOR®



⑩ Axor Citterio E
220 mm avec rosace
AXOR®



Corps encastré Set de finition :
espacement de 220 mm



①① Axor Uno²
165 mm avec rosace
AXOR®



①② Axor Uno²
165 mm avec plaque
AXOR®



①③ Axor Citterio M
177 mm avec rosace
AXOR®



①④ Axor Citterio M
177 mm avec plaque
AXOR®



①⑤ Axor Citterio
165 mm avec rosace
AXOR®



①⑥ Axor Citterio
165 mm avec plaque
AXOR®

CHIFFRAGE DES SOLUTIONS*

Logis -Talis - Metris - Metris S - Metris Classic - PuraVida Axor Bouroullec - Axor Citterio E - Axor Uno² - Axor Citterio M - Axor Citterio

① Logis - Chromé

71220000	Mitigeur encastré mural	170,00
13622180	Corps encastré	220,00
TOTAL HT		379,00

② Talis - Chromé

31618000	Mitigeur encastré mural	214,00
13622180	Corps encastré	214,00
TOTAL HT		428,00

③ ⑤ Talis S - Chromé

72110000	Mitigeur encastré mural	229,00
13622180	Corps encastré	220,00
TOTAL HT		449,00

④ Talis E - Chromé

71734000	Mitigeur encastré mural	229,00
13622180	Corps encastré	220,00
TOTAL HT		449,00

⑤ Metris - Chromé

31085000	Mitigeur encastré mural	286,00
13622180	Corps encastré	220,00
TOTAL HT		491,00

⑥ Metris S - Chromé

31162000	Mitigeur encastré mural	319,00
13622180	Corps encastré	214,00
TOTAL HT		533,00

⑦ PuraVida - Chromé

15084000	Mitigeur encastré mural	521,00
13622180	Corps encastré	214,00
TOTAL HT		735,00

⑧ Axor Bouroullec - Chromé

19125000	Mitigeur encastré mural	414,00
13622180	Corps encastré	214,00
TOTAL HT		628,00

⑨ Axor Citterio E avec plaque- Chromé

36114000	Mitigeur encastré mural	615,00
13622180	Corps encastré	214,00
TOTAL HT		829,00

⑩ Axor Citterio E avec rosace - Chromé

36106000	Mitigeur encastré mural	625,00
13622180	Corps encastré	214,00
TOTAL HT		839,00

①① Axor Uno² avec rosace - Chromé

38113000	Mitigeur encastré mural	377,00
13622180	Corps encastré	214,00
TOTAL HT		591,00

①② Axor Uno² avec plaque - Chromé

38112000	Mitigeur encastré mural	573,00
13622180	Corps encastré	214,00
TOTAL HT		787,00

①③ Axor Citterio M avec rosace - Chromé

34113000	Mitigeur encastré mural	527,00
13622180	Corps encastré	214,00
TOTAL HT		741,00

①④ Axor Citterio M avec plaque - Chromé

34112000	Mitigeur encastré mural	615,00
13622180	Corps encastré	214,00
TOTAL HT		829,00

①⑤ Axor Citterio avec rosace - Chromé

39113000	Mitigeur encastré mural	554,00
13622180	Corps encastré	214,00
TOTAL HT		768,00

①⑥ Axor Citterio avec plaque - Chromé

39112000	Mitigeur encastré mural	688,00
13622180	Corps encastré	214,00
TOTAL HT		902,00

* Chiffrage pour les mitigeurs dont la longueur du bec se situe entre 161 et 200 mm.
Ces modèles existent avec des longueurs de bec plus importantes (cf. catalogues Hansgrohe et Axor)

Les solutions pour la douche

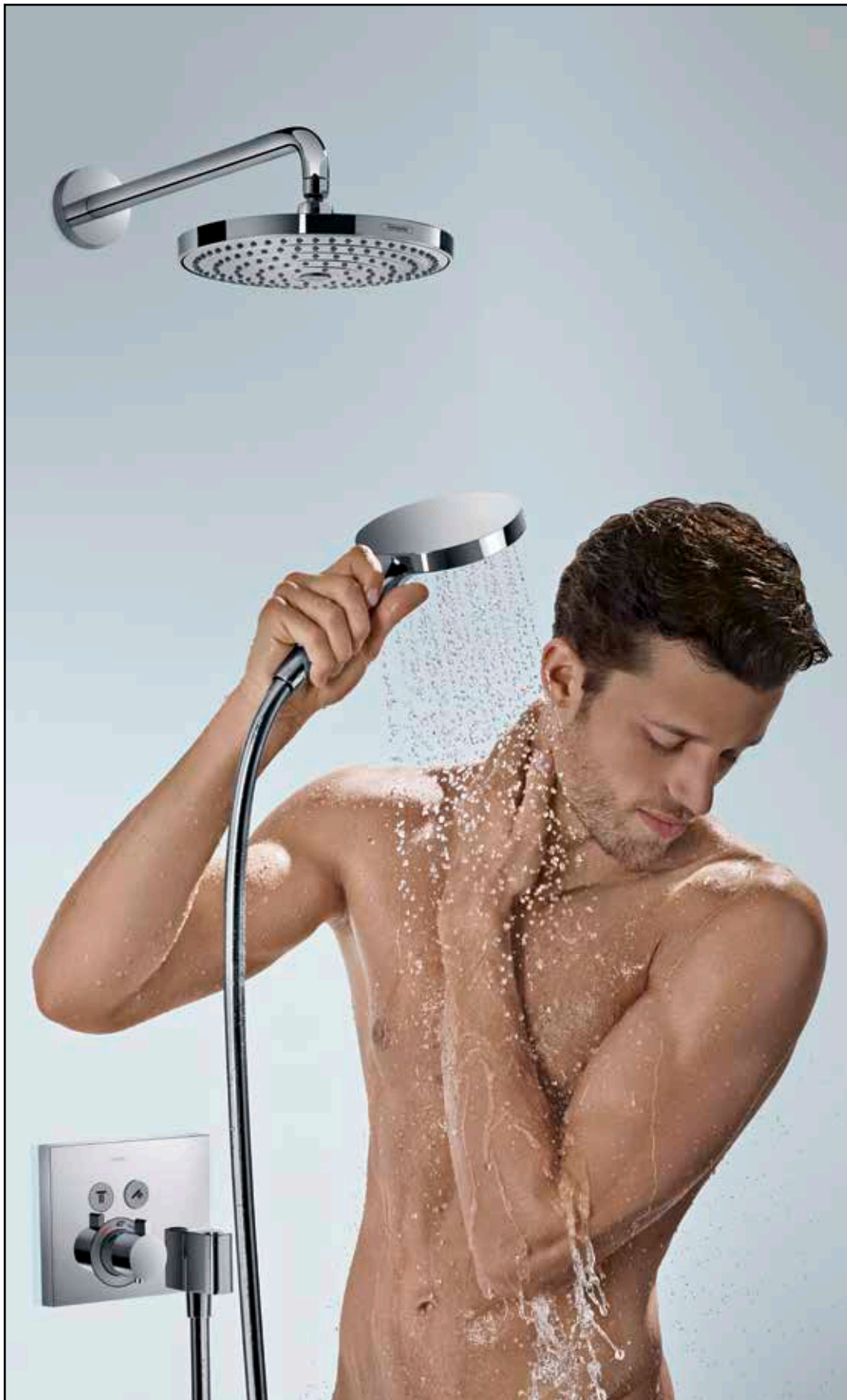



Raindance Rainfall 150 Stream



Croma 220

2150 mm*

1200 mm*

1000 mm*

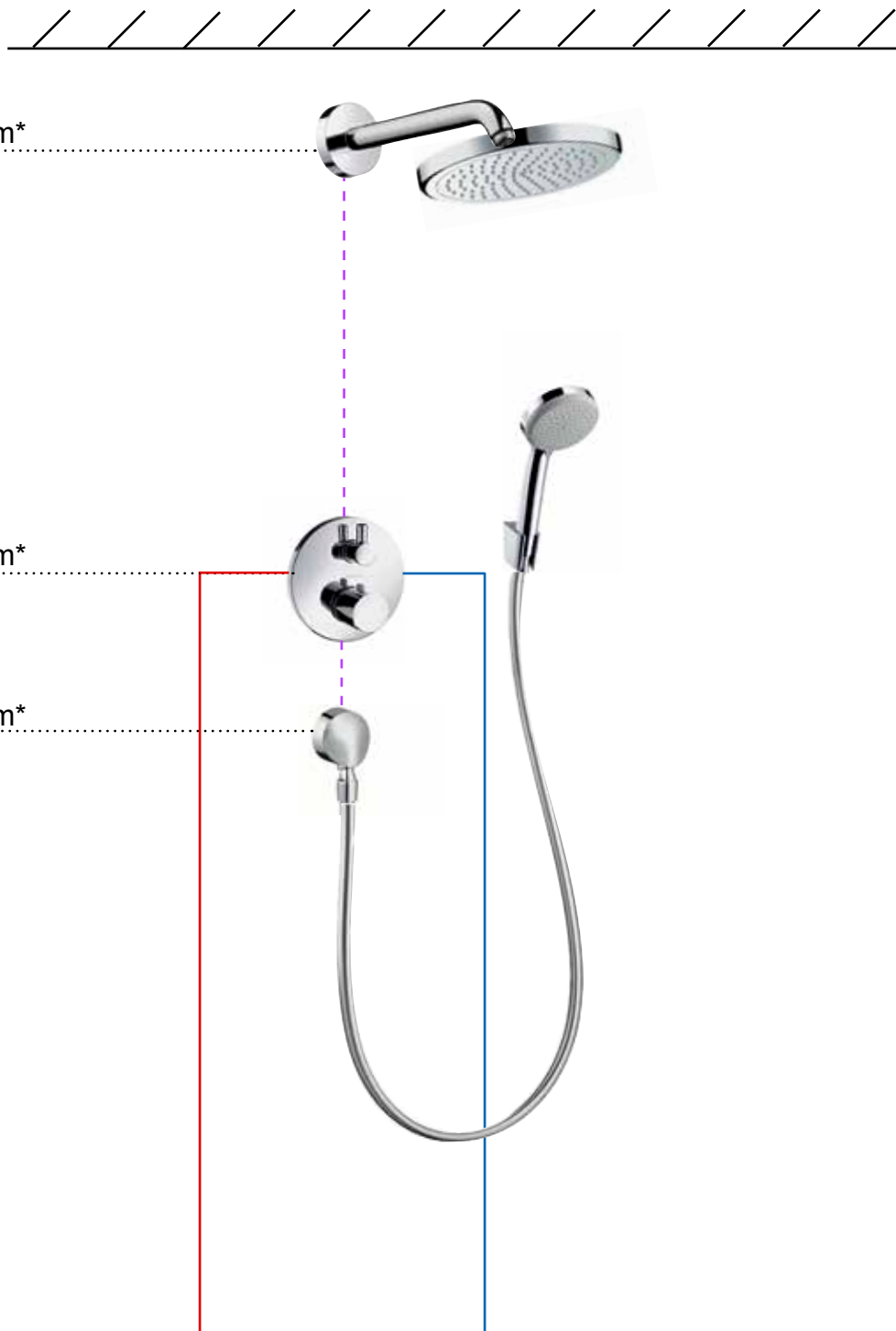

iBox + Mitigeurs

iBox + Thermostatiques



① Focus



② Talis



③ Metris



④ Metris S



⑤ Ecostat E



⑥ Ecostat S

CHIFFRAGE DES SOLUTIONS

Focus - Talis - Metris - Metris S - Ecostat E - Ecostat S

Raiance Rainfall Stream ① Mitigeur Focus - Chromé		
01800180	iBox	105,00
31945000	Mitigeur encastré Focus	149,00
26443000	DT Raiance Rainfall Stream	265,00
27505000	Fixfit	30,00
27594000	Porter'S/Croma 100 Vario	67,00
TOTAL HT		616,00

Raiance Rainfall Stream ② Mitigeur Talis - Chromé		
01800180	iBox	105,00
32475000	Mitigeur encastré Talis	174,00
26443000	DT Raiance Rainfall Stream	265,00
27505000	Fixfit	30,00
27594000	Porter'S/Croma 100 Vario	67,00
TOTAL HT		641,00

Raiance Rainfall Stream ③ Mitigeur Metris - Chromé		
01800180	iBox	105,00
31493000	Mitigeur encastré Metris	205,00
26443000	DT Raiance Rainfall Stream	265,00
27505000	Fixfit	30,00
27594000	Porter'S/Croma 100 Vario	67,00
TOTAL HT		672,00

Raiance Rainfall Stream ④ Mitigeur Metris S - Chromé		
01800180	iBox	105,00
31465000	Mitigeur encastré Metris S	215,00
26443000	DT Raiance Rainfall Stream	265,00
27505000	Fixfit	30,00
27594000	Porter'S/Croma 100 Vario	67,00
TOTAL HT		682,00

Raiance Rainfall Stream ⑤ Thermostatique Ecostat E - Chromé		
01800180	iBox	105,00
31573000	Thermostatique Ecostat E	553,00
26443000	DT Raiance Rainfall Stream	265,00
27505000	Fixfit	30,00
27594000	Porter'S/Croma 100 Vario	67,00
TOTAL HT		1020,00

Raiance Rainfall Stream ⑥ Thermostatique Ecostat S - Chromé		
01800180	iBox	105,00
15721000	Thermostatique Ecostat S	673,00
26443000	DT Raiance Rainfall Stream	265,00
27505000	Fixfit	30,00
27594000	Porter'S/Croma 100 Vario	67,00
TOTAL HT		1140,00

Croma 220 ① Mitigeur Focus - Chromé		
01800180	iBox	105,00
31945000	Mitigeur encastré Focus	149,00
27412000	Bras de douche 230 mm	61,00
27505000	Fixfit	30,00
26464000	Douche de tête Croma 220	225,00
27594000	Porter'S/Croma 100 Vario	67,00
TOTAL HT		637,00

Croma 220 ② Mitigeur Talis - Chromé		
01800180	iBox	105,00
32475000	Mitigeur encastré Talis	174,00
27412000	Bras de douche 230 mm	61,00
27505000	Fixfit	30,00
26464000	Douche de tête Croma 220	225,00
27594000	Porter'S/Croma 100 Vario	67,00
TOTAL HT		662,00

Croma 220 ③ Mitigeur Metris - Chromé		
01800180	iBox	105,00
31493000	Mitigeur encastré Metris	205,00
27412000	Bras de douche 230 mm	61,00
27505000	Fixfit	30,00
26464000	Douche de tête Croma 220	225,00
27594000	Porter'S/Croma 100 Vario	67,00
TOTAL HT		693,00

Croma 220 ④ Mitigeur Metris S - Chromé		
01800180	iBox	105,00
31465000	Mitigeur encastré Metris S	215,00
27412000	Bras de douche 230 mm	61,00
27505000	Fixfit	30,00
26464000	Douche de tête Croma 220	225,00
27594000	Porter'S/Croma 100 Vario	67,00
TOTAL HT		703,00

Croma 220 ⑤ Thermostatique Ecostat E - Chromé		
01800180	iBox	105,00
31573000	Thermostatique Ecostat E	553,00
27412000	Bras de douche 230 mm	61,00
27505000	Fixfit	30,00
26464000	Douche de tête Croma 220	225,00
27594000	Porter'S/Croma 100 Vario	67,00
TOTAL HT		1041,00

Croma 220 ⑥ Thermostatique Ecostat S - Chromé		
01800180	iBox	105,00
15721000	Thermostatique Ecostat S	673,00
27412000	Bras de douche 230 mm	61,00
27505000	Fixfit	30,00
26464000	Douche de tête Croma 220	225,00
27594000	Porter'S/Croma 100 Vario	67,00
TOTAL HT		1161,00

Dans le cas d'un encastrement dans un mur dont l'épaisseur est inférieure à 80 mm et supérieure à 58 mm, prévoir une rosace de compensation (cf. p.3)



Raindance E 240 1jet



Raindance E 360 1jet

2150 mm*

1200 mm*

1000 mm*

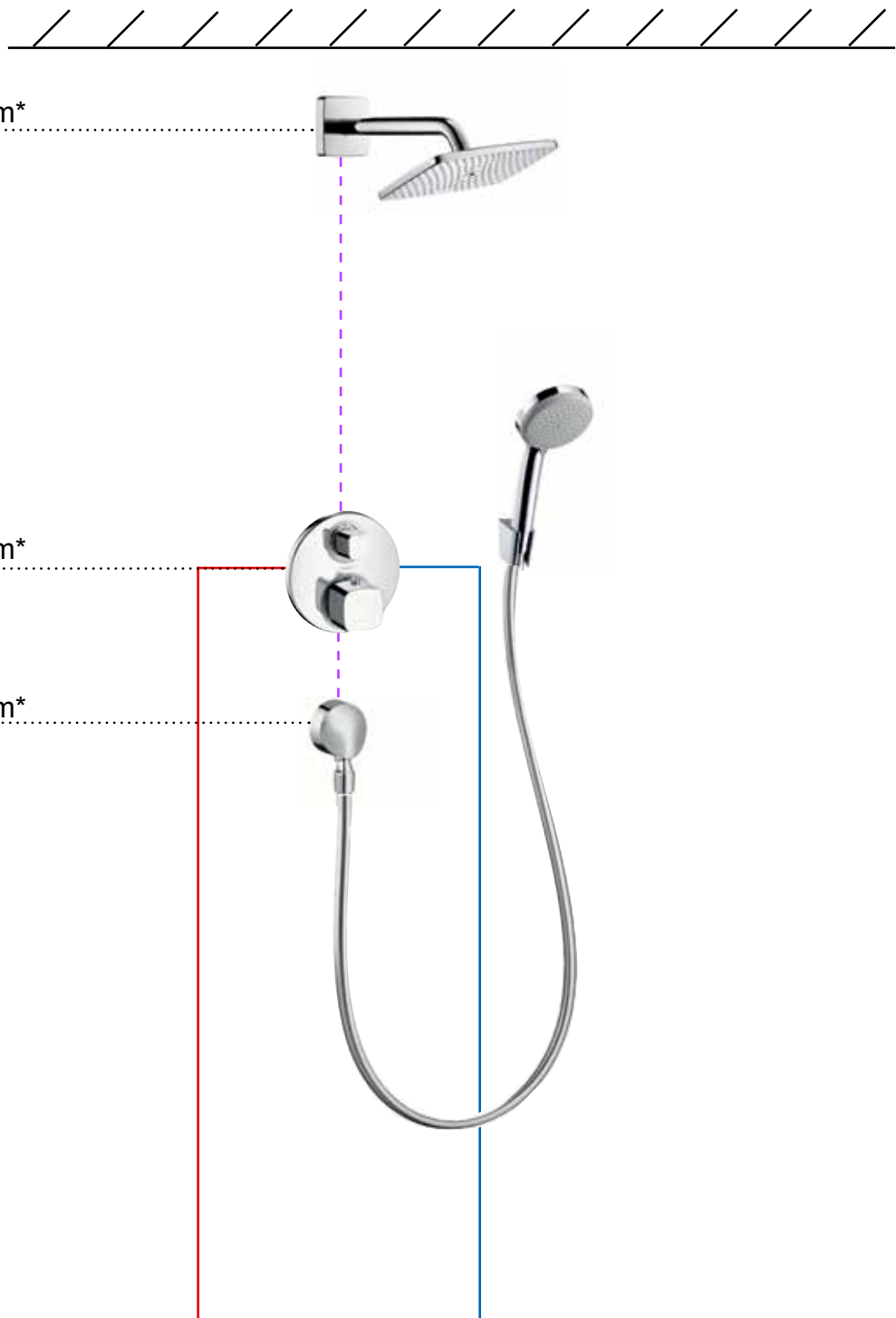

iBox + Mitigeurs



① Focus

② Talis

③ Metris

④ Metris S

iBox + Thermostatiques



⑤ Ecostat E

⑥ Ecostat S

CHIFFRAGE DES SOLUTIONS

Focus - Talis - Metris - Metris S - Ecostat E - Ecostat S

Raindance E 240 1jet ① Mitigeur Focus - Chromé		
01800180	iBox	105,00
31945000	Mitigeur encastré Focus	149,00
27370000	DT Raindance E 240 1jet	510,00
27505000	Fixfit	30,00
27594000	Porter'S/Croma 100 Vario	67,00
TOTAL HT		861,00

Raindance E 360 1jet ① Mitigeur Focus - Chromé		
01800180	iBox	105,00
31945000	Mitigeur encastré Focus	149,00
27376000	DT Raindance E 360 1jet	635,00
27505000	Fixfit	30,00
27594000	Porter'S/Croma 100 Vario	67,00
TOTAL HT		986,00

Raindance E 240 1jet ② Mitigeur Talis - Chromé		
01800180	iBox	105,00
32475000	Mitigeur encastré Talis	174,00
27370000	DT Raindance E 240 1jet	510,00
27505000	Fixfit	30,00
27594000	Porter'S/Croma 100 Vario	67,00
TOTAL HT		886,00

Raindance E 360 1jet ② Mitigeur Talis - Chromé		
01800180	iBox	105,00
32475000	Mitigeur encastré Talis	174,00
27376000	DT Raindance E 360 1jet	635,00
27505000	Fixfit	30,00
27594000	Porter'S/Croma 100 Vario	67,00
TOTAL HT		1011,00

Raindance E 240 1jet ③ Mitigeur Metris - Chromé		
01800180	iBox	105,00
31493000	Mitigeur encastré Metris	205,00
27370000	DT Raindance E 240 1jet	510,00
27505000	Fixfit	30,00
27594000	Porter'S/Croma 100 Vario	67,00
TOTAL HT		917,00

Raindance E 360 1jet ③ Mitigeur Metris - Chromé		
01800180	iBox	105,00
31493000	Mitigeur encastré Metris	205,00
27376000	DT Raindance E 360 1jet	635,00
27505000	Fixfit	30,00
27594000	Porter'S/Croma 100 Vario	67,00
TOTAL HT		1042,00

Raindance E 240 1jet ④ Mitigeur Metris S - Chromé		
01800180	iBox	105,00
31465000	Mitigeur encastré Metris S	215,00
27370000	DT Raindance E 240 1jet	510,00
27505000	Fixfit	30,00
27594000	Porter'S/Croma 100 Vario	67,00
TOTAL HT		927,00

Raindance E 360 1jet ④ Mitigeur Metris S - Chromé		
01800180	iBox	105,00
31465000	Mitigeur encastré Metris S	215,00
27376000	DT Raindance E 360 1jet	635,00
27505000	Fixfit	30,00
27594000	Porter'S/Croma 100 Vario	67,00
TOTAL HT		1022,00

Raindance E 240 1jet ⑤ Thermostatique Ecostat E - Chromé		
01800180	iBox	105,00
31573000	Thermostatique Ecostat E	553,00
27370000	DT Raindance E 240 1jet	510,00
27505000	Fixfit	30,00
27594000	Porter'S/Croma 100 Vario	67,00
TOTAL HT		1265,00

Raindance E 360 1jet ⑤ Thermostatique Ecostat E - Chromé		
01800180	iBox	105,00
31573000	Thermostatique Ecostat E	553,00
27376000	DT Raindance E 360 1jet	635,00
27505000	Fixfit	30,00
27594000	Porter'S/Croma 100 Vario	67,00
TOTAL HT		1390,00

Raindance E 240 1jet ⑥ Thermostatique Ecostat S - Chromé		
01800180	iBox	105,00
15721000	Thermostatique Ecostat S	673,00
27370000	DT Raindance E 240 1jet	510,00
27505000	Fixfit	30,00
27594000	Porter'S/Croma 100 Vario	67,00
TOTAL HT		1385,00

Raindance E 360 1jet ⑥ Thermostatique Ecostat S - Chromé		
01800180	iBox	105,00
15721000	Thermostatique Ecostat S	673,00
27376000	DT Raindance E 360 1jet	635,00
27505000	Fixfit	30,00
27594000	Porter'S/Croma 100 Vario	67,00
TOTAL HT		1510,00

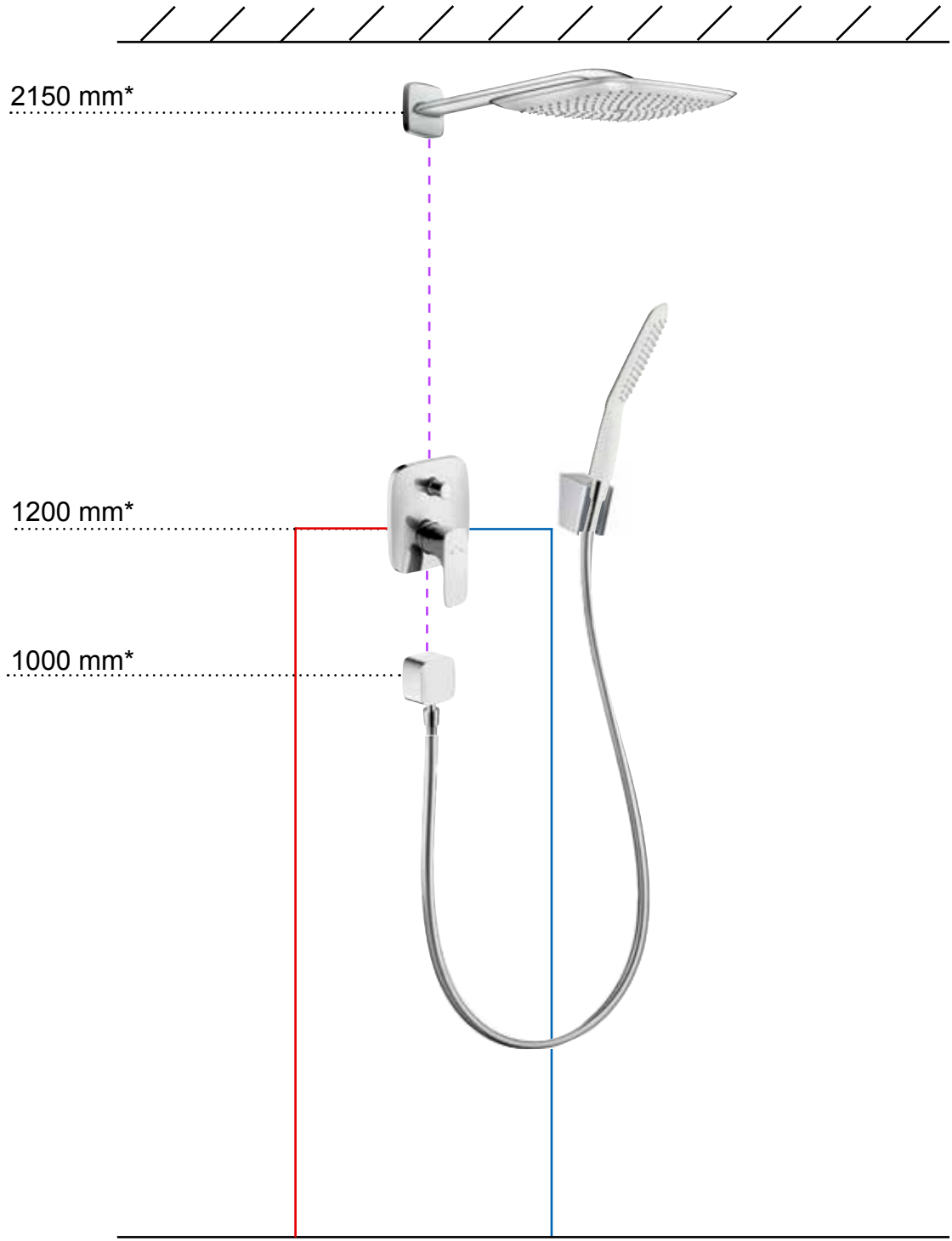
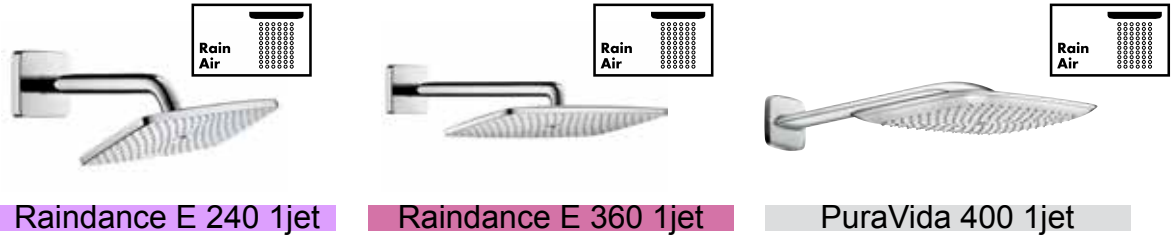

① Mitigeur PuraVida



② Thermostatique PuraVida

CHIFFRAGE DES SOLUTIONS PuraVida

Raindance E 240 1jet ① Mitigeur PuraVida - Chromé

01800180	iBox	105,00
15445000	Mitigeur bain/douche	435,00
27414000	Fixfit PuraVida	44,00
28331000	Porter'S	25,00
28558000	Douchette 120 1jet	100,00
28276000	Isiflex 1,60 m	28,00
27370000	DT Raindance E 240 1jet	510,00
TOTAL HT		1.247,00

Raindance E 240 1jet ② Thermostatique PuraVida - Chromé

01800180	iBox	105,00
15771000	Thermostatique RA+inverseur	1.095,00
27414000	Fixfit PuraVida	44,00
28331000	Porter'S	25,00
28558000	Douchette 120 1jet	100,00
28276000	Isiflex 1,60 m	28,00
27370000	DT Raindance E 240 1jet	510,00
TOTAL HT		1.907,00

Raindance E 360 1jet ① Mitigeur PuraVida - Chromé

01800180	iBox	105,00
15445000	Mitigeur bain/douche	435,00
27414000	Fixfit PuraVida	44,00
28331000	Porter'S	25,00
28558000	Douchette 120 1jet	100,00
28276000	Isiflex 1,60 m	28,00
27376000	DT Raindance E 360 1jet	635,00
TOTAL HT		1.372,00

Raindance E 360 1jet ② Thermostatique PuraVida - Chromé

01800180	iBox	105,00
15771000	Thermostatique RA+inverseur	1.095,00
27414000	Fixfit PuraVida	44,00
28331000	Porter'S	25,00
28558000	Douchette 120 1jet	100,00
28276000	Isiflex 1,60 m	28,00
27376000	DT Raindance E 360 1jet	635,00
TOTAL HT		2.032,00

PuraVida 400 1jet ① Mitigeur PuraVida - Blanc/chromé

01800180	iBox	105,00
15445400	Mitigeur bain/douche	435,00
27414000	Fixfit PuraVida	44,00
28331000	Porter'S	25,00
28558400	Douchette 120 1jet	100,00
28276000	Isiflex 1,60 m	28,00
27437400	DT PuraVida 400 1jet	1.195,00
TOTAL HT		1.932,00

PuraVida 400 1jet ② Thermostatique PuraVida - Blanc/chromé

01800180	iBox	105,00
15771400	Thermostatique RA+inverseur	1.095,00
27414000	Fixfit PuraVida	44,00
28331000	Porter'S	25,00
28558400	Douchette 120 1jet	100,00
28276000	Isiflex 1,60 m	28,00
27437400	DT PuraVida 400 1jet	1.195,00
TOTAL HT		2.592,00



Raindance Rainfall 150 Stream

Raindance Select E 300 2jet

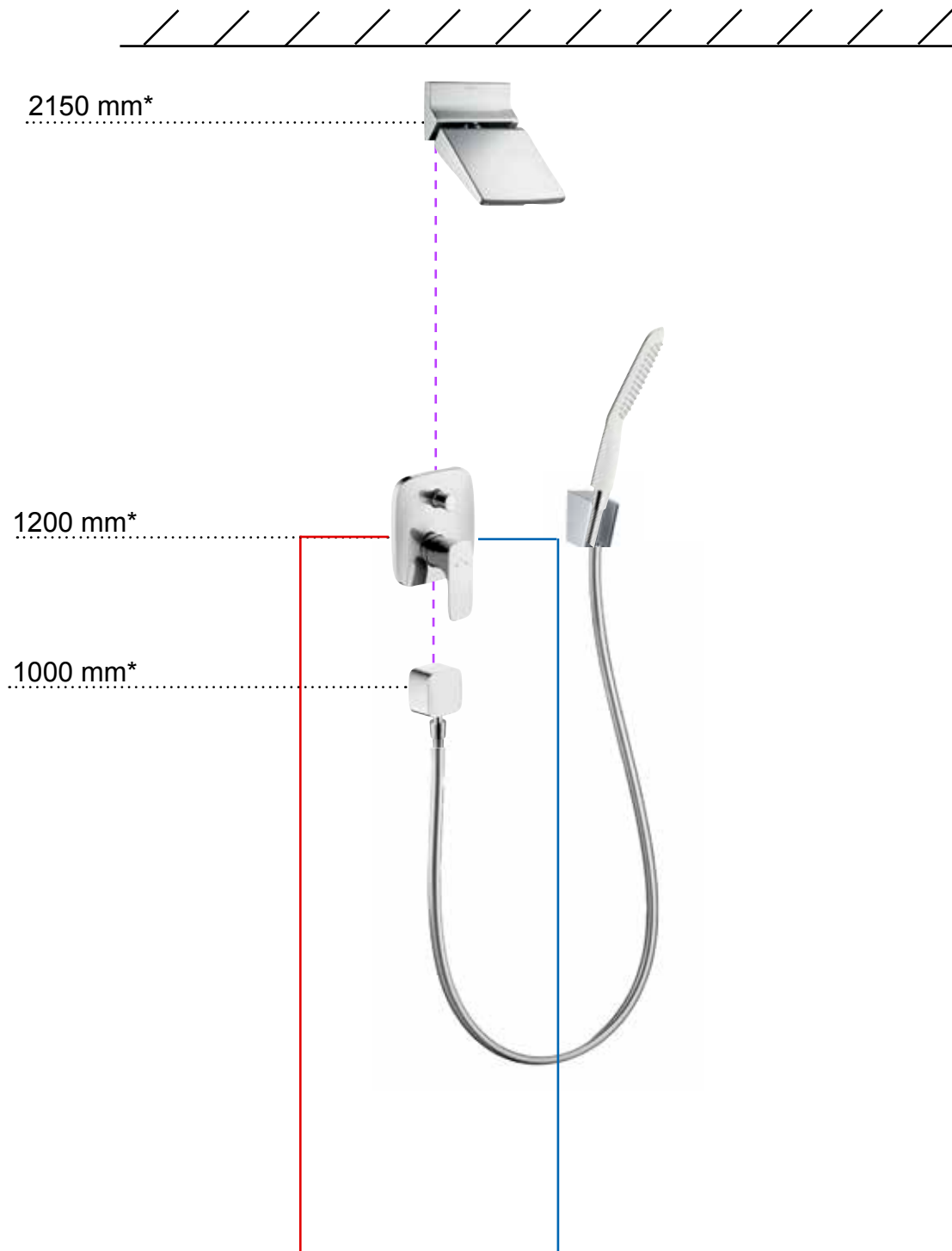

iBox



① Mitigeur PuraVida

iBox



② Thermostatique PuraVida

CHIFFRAGE DES SOLUTIONS PuraVida

Raindance Rainfall Stream ① Mitigeur PuraVida - Chromé		
01800180	iBox	105,00
15445000	Mitigeur bain/douche	435,00
27414000	Fixfit PuraVida	44,00
28331000	Porter'S	25,00
28558000	Douchette 120 1jet	100,00
28276000	Isiflex 1,60 m	28,00
26443000	Raindance Rainfall Stream	265,00
TOTAL HT		1.002,00

Raindance Rainfall Stream ② Thermostatique PuraVida - Chromé		
01800180	iBox	105,00
15771000	Thermostatique RA+inverseur	1.095,00
27414000	Fixfit PuraVida	44,00
28331000	Porter'S	25,00
28558000	Douchette 120 1jet	100,00
28276000	Isiflex 1,60 m	28,00
26443000	Raindance Rainfall Stream	265,00
TOTAL HT		1.662,00

Raindance Select E 300 2jet ① Mitigeur PuraVida - Blanc/chromé		
01800180	iBox	105,00
15445400	Mitigeur bain/douche	435,00
27414000	Fixfit PuraVida	44,00
28331000	Porter'S	25,00
28558400	Douchette 120 1jet	100,00
28276000	Isiflex 1,60 m	28,00
27385400	Raindance Select E 300 2jet	570,00
TOTAL HT		1.307,00

Raindance Select E 300 2jet ② Thermostatique PuraVida - Blanc/chromé		
01800180	iBox	105,00
15771400	Thermostatique RA+inverseur	1.095,00
27414000	Fixfit PuraVida	44,00
28331000	Porter'S	25,00
28558400	Douchette 120 1jet	100,00
28276000	Isiflex 1,60 m	28,00
27385400	Raindance Select E 300 2jet	570,00
TOTAL HT		1.967,00

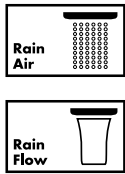

Raindance E 420 2jet



Raindance Rainfall 180 2jet

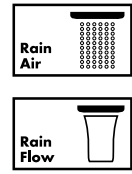

2150 mm*

1200 mm*

1000 mm*

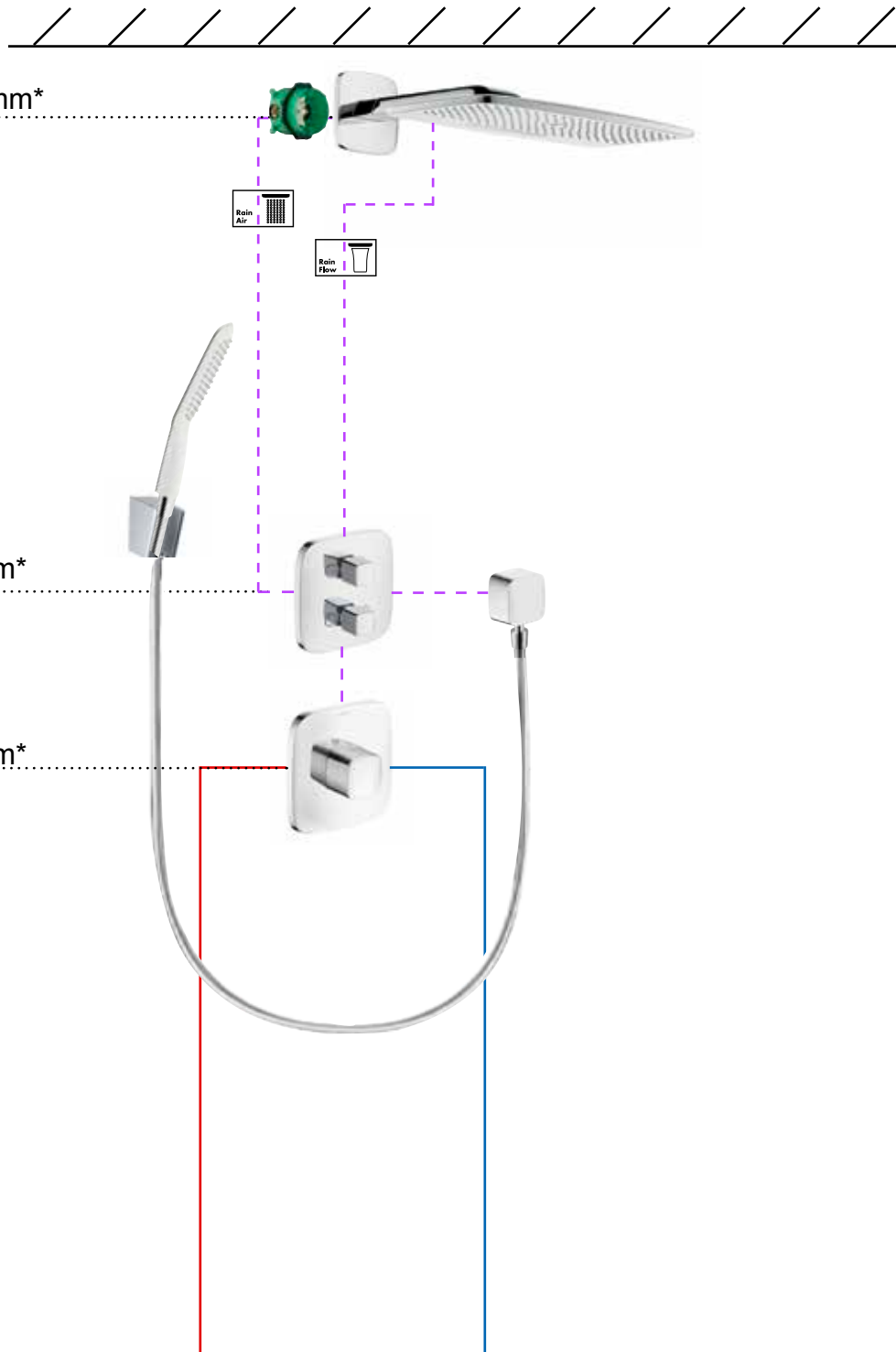

Thermostatique PuraVida haut débit

+



iControl PuraVida

CHIFFRAGE DES SOLUTIONS PuraVida

Douche de tête Raindance E 420 2jet - Chromé Thermostatique haut débit et iControl PuraVida

01800180 x 3	iBox	315,00
15772000	Thermostatique haut débit	840,00
15777000	iControl PuraVida	410,00
27373000	Douche de tête Raindance E 420 2jet	1.175,00
27414000	Fixfit PuraVida	44,00
28331000	Porter'S	25,00
28276000	Isiflex 1,60 m	28,00
28558000	Douchette 120 1jet	100,00
TOTAL HT		2.937,00

Douche de tête Raindance Rainfall 180 2jet - Chromé Thermostatique haut débit et iControl PuraVida

01800180 x 3	iBox	315,00
15772000	Thermostatique haut débit	840,00
15777000	iControl PuraVida	410,00
28433000	Douche de tête Raindance Rainfall 2jet	1.330,00
27414000	Fixfit PuraVida	44,00
28331000	Porter'S	25,00
28276000	Isiflex 1,60 m	28,00
28558000	Douchette 120 1jet	100,00
TOTAL HT		3.092,00

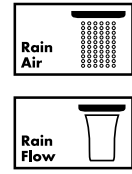
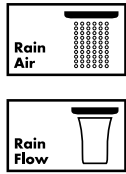

Raindance E 420 2jet

Raindance Rainfall 180 2jet

2150 mm*

1200 mm*

1000 mm*

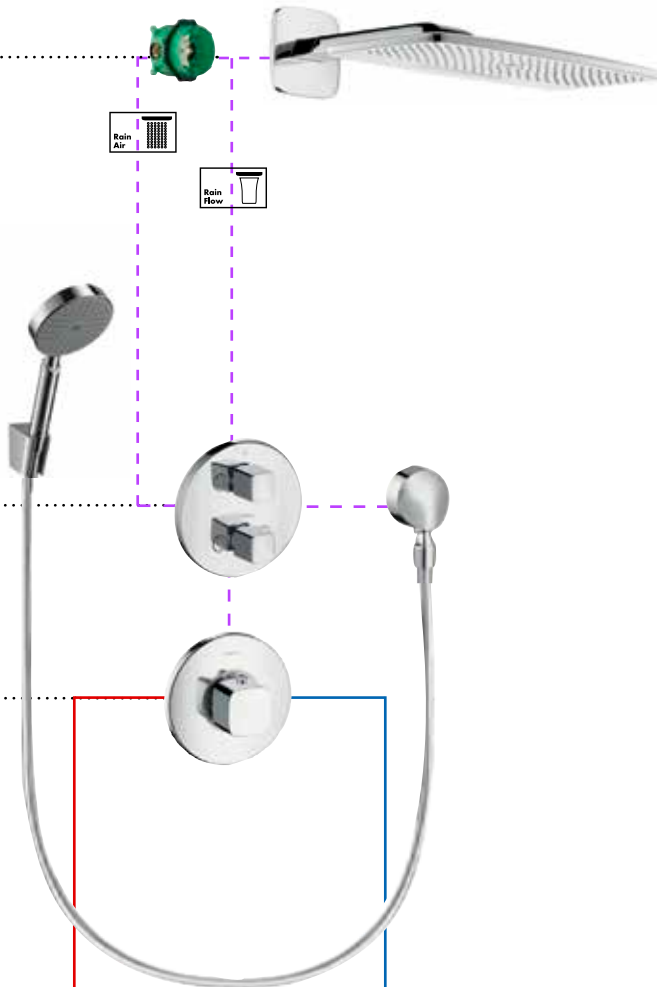

Montage Raindance E 420 2jet

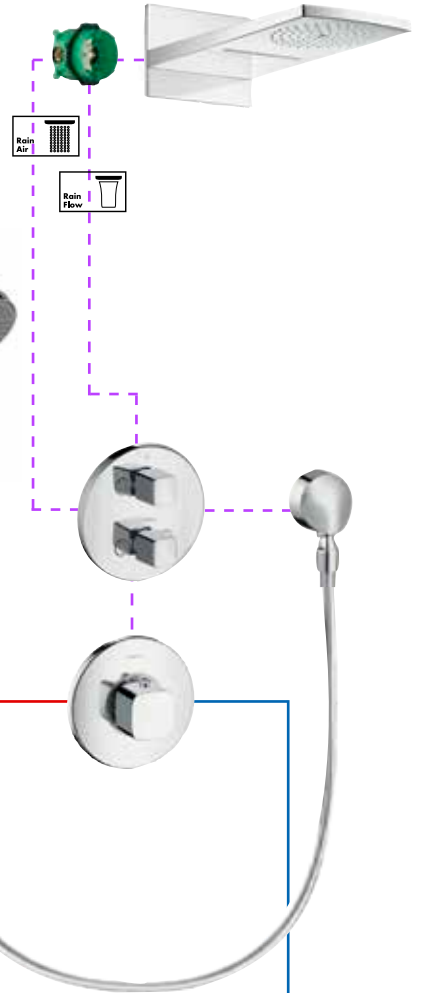

Montage Raindance Rainfall 180 2jet

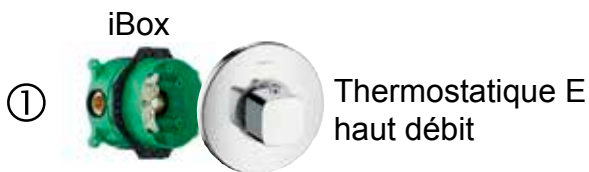

+

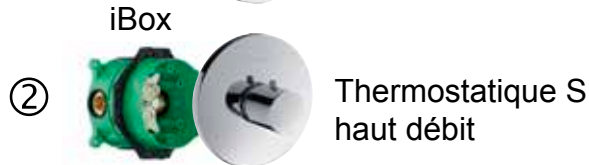

+



CHIFFRAGE DES SOLUTIONS

Ecostat E - Ecostat S

Raindance E 420 2jet - Chromé

① Thermostatique Ecostat E haut débit et iControl

01800180 x 3	iBox	315,00
31571000	Thermostatique haut débit	512,00
31958000	iControl	358,00
27373000	Raindance E 420 2jet	1.175,00
27505000	Fixfit E	30,00
27581000	Porter'S/Raindance S 100	132,00
TOTAL HT		2.522,00

Raindance Rainfall 180 2jet - Chromé

① Thermostatique Ecostat E haut débit et iControl

01800180 x 3	iBox	315,00
31571000	Thermostatique haut débit	512,00
31958000	iControl	358,00
28433000	Raindance Rainfall 2jet	1.330,00
27506000	Fixfit S	34,00
27581000	Porter'S/Raindance S 100	132,00
TOTAL HT		2.681,00

Raindance E 420 2jet - Chromé

② Thermostatique Ecostat S haut débit et iControl

01800180 x 3	iBox	315,00
15715000	Thermostatique haut débit	530,00
15955000	iControl	415,00
27373000	Raindance E 420 2jet	1.175,00
27505000	Fixfit E	30,00
27581000	Porter'S/Raindance S 100	132,00
TOTAL HT		2.597,00

Raindance Rainfall 180 2jet - Chromé

② Thermostatique Ecostat S haut débit et iControl

01800180 x 3	iBox	315,00
15715000	Thermostatique haut débit	530,00
15955000	iControl	415,00
28433000	Raindance Rainfall 2jet	1.330,00
27506000	Fixfit S	34,00
27581000	Porter'S/Raindance S 100	132,00
TOTAL HT		2.756,00

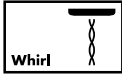
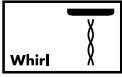

Raindance Rainmaker 680x460mm

Raindance Rainfall 240 3jet

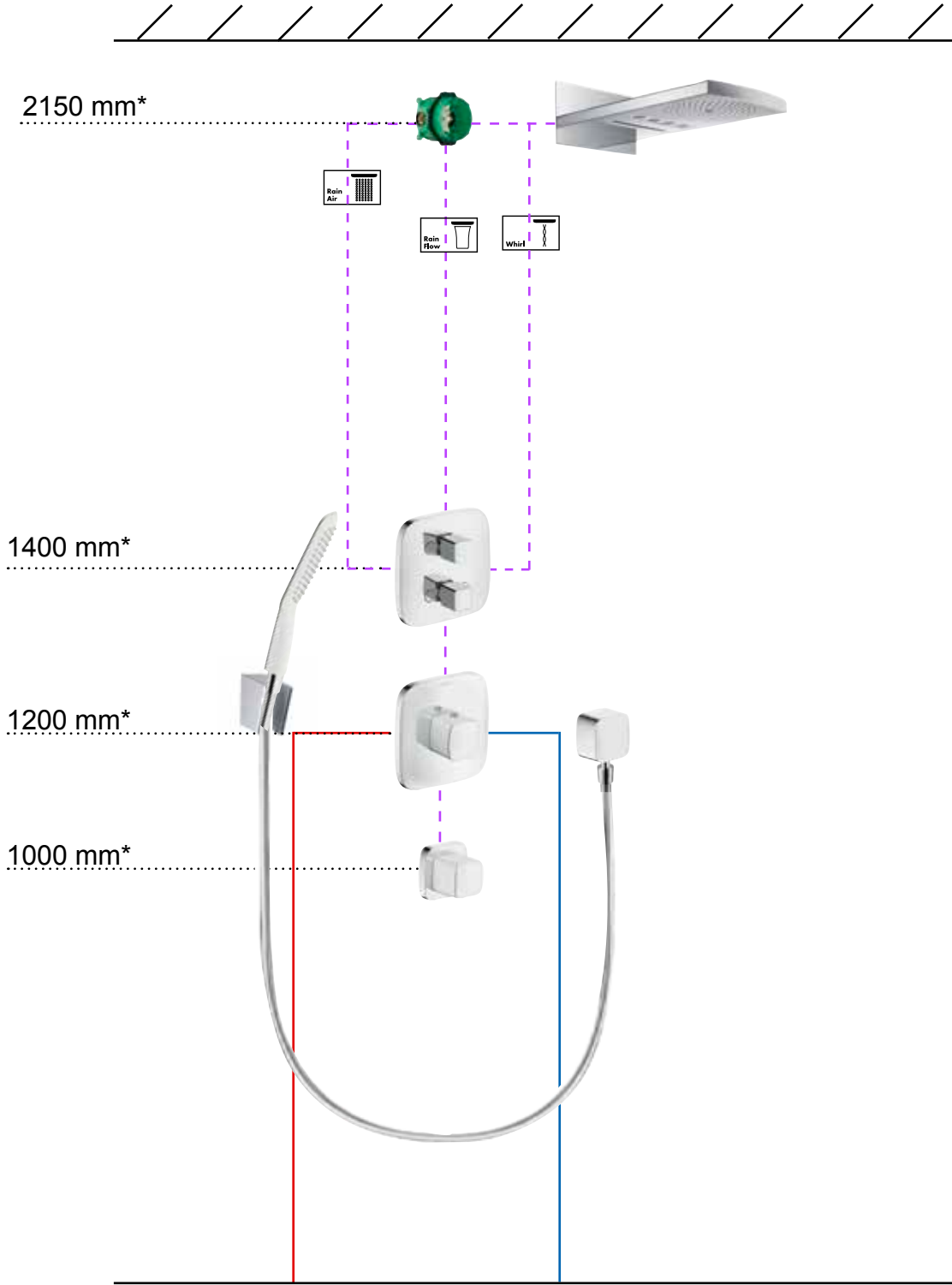

Thermostatique PuraVida haut débit

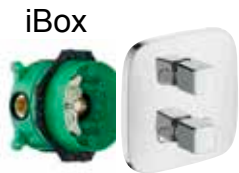

iControl PuraVida

* Les hauteurs indiquées sont mesurées à partir du sol fini.

CHIFFRAGE DES SOLUTIONS PuraVida

Raindance Rainmaker 680x460 mm - Blanc/chromé Thermostatique PuraVida haut débit et iControl

01800180 x 2	iBox	210,00
15772400	Thermostatique haut débit PuraVida	840,00
15777400	iControl PuraVida	410,00
15978400	Robinet d'arrêt	139,00
15974180	Corps enc. rob. arrêt	82,00
28417000	DT Raindance Rainmaker	3.970,00
28414180	Corps enc. Rainmaker	102,00
27414000	Fixfit PuraVida	44,00
28276000	Isiflex 1,60 m	28,00
28331000	Porter'S	25,00
28558400	Douchette 120 1jet	100,00
TOTAL HT		5.950,00

Raindance Rainfall 240 3jet - Blanc/chromé Thermostatique PuraVida haut débit et iControl

01800180 x 3	iBox	315,00
15772400	Thermostatique haut débit PuraVida	840,00
15777400	iControl PuraVida	410,00
15978400	Robinet d'arrêt	139,00
15974180	Corps enc. rob. arrêt	82,00
28411400	DT Raindance Rainfall 3jet	2.630,00
27414000	Fixfit PuraVida	44,00
28276000	Isiflex 1,60 m	28,00
28331000	Porter'S	25,00
28558400	Douchette 120 1jet	100,00
TOTAL HT		4.613,00

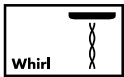

Raindance Rainmaker 680x460mm

Raindance Rainfall 240 3jet

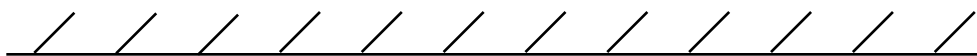

2150 mm*



1400 mm*

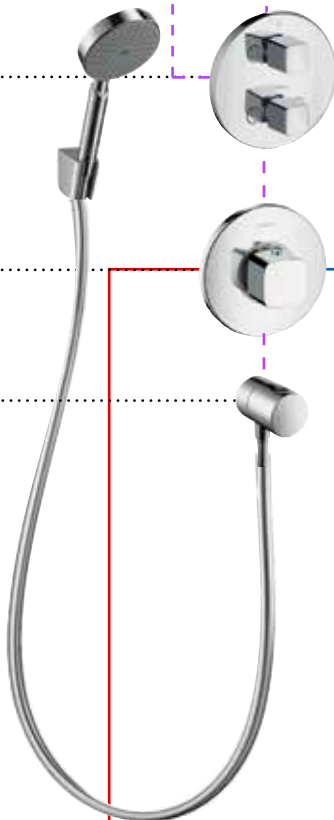

1200 mm*

1000 mm*

iBox



①

Thermostatique E
haut débit

+

iBox



iControl E

iBox



②

Thermostatique S
haut débit

+

iBox



iControl s

CHIFFRAGE DES SOLUTIONS

Ecostat E - Ecostat S

Raindance Rainmaker 680x460 mm - Chromé ① Thermostatique Ecostat E haut débit et iControl

01800180 x 2	iBox	210,00
31571000	Thermostatique haut débit	512,00
31958000	iControl	358,00
28417000	Raindance Rainmaker	3.970,00
28414180	Corps enc. Rainmaker	102,00
38882000	Fixfit Stop	183,00
27581000	Porter'S/Raindance S 100	132,00
TOTAL HT		5.467,00

Raindance Rainfall 240 3jet - Chromé ① Thermostatique Ecostat E haut débit et iControl

01800180 x 3	iBox	315,00
31571000	Thermostatique haut débit	512,00
31958000	iControl	358,00
28411000	Raindance Rainfall 3jet	2.630,00
38882000	Fixfit Stop	183,00
27581000	Porter'S/Raindance S 100	132,00
TOTAL HT		4.130,00

Raindance Rainmaker 680x460 mm - Chromé ② Thermostatique Ecostat S haut débit et iControl

01800180 x 2	iBox	210,00
15715000	Thermostatique haut débit	530,00
15955000	iControl	415,00
28417000	Raindance Rainmaker	3.970,00
28414180	Corps enc. Rainmaker	102,00
38882000	Fixfit Stop	183,00
27581000	Porter'S/Raindance S 100	132,00
TOTAL HT		5.542,00

Raindance Rainfall 240 3jet - Chromé ② Thermostatique Ecostat S haut débit et iControl

01800180 x 3	iBox	310,00
15715000	Thermostatique haut débit	530,00
15955000	iControl	415,00
28411000	Raindance Rainfall 3jet	2.630,00
38882000	Fixfit Stop	183,00
27581000	Porter'S/Raindance S 100	132,00
TOTAL HT		4.205,00

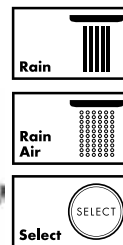
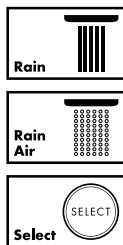

Raindance Rainfall 150

Raindance Select E 300 2jet

Raindance Select S 300 2jet

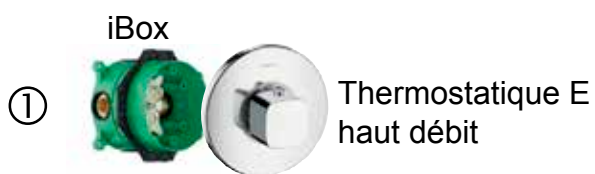

+

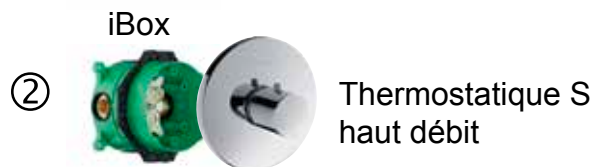
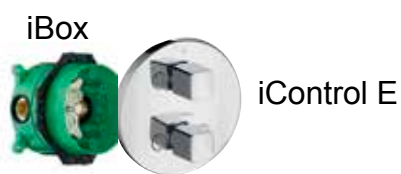

+

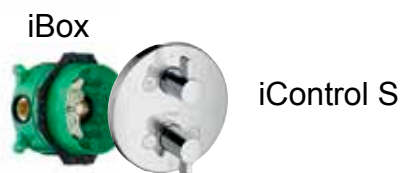

CHIFFRAGE DES SOLUTIONS

Ecostat E - Ecostat S

Raindance Rainfall 150 ① Version E - Chromé

01800180 x 2	iBox	210,00
31571000	Ecostat E haut débit	512,00
31958000	iControl E	358,00
26442000	DT Raindance Rainfall 150	265,00
28477000 x 6	Douche latérale Raindance 100 S	738,00
27505000	Fixfit	30,00
27581000	Porter'S/Raindance S 100	132,00
TOTAL HT		2.245,00

Raindance Rainfall 150 ② Version S - Chromé

01800180 x 2	iBox	210,00
15715000	Ecostat S haut débit	530,00
15955000	iControl S	415,00
26442000	DT Raindance Rainfall 150	265,00
28477000 x 6	Douche latérale Raindance 100 S	738,00
27505000	Fixfit	30,00
27581000	Porter'S/Raindance S 100	132,00
TOTAL HT		2.320,00

Raindance Select E 300 2jet ① Version E - Chromé

01800180 x 2	iBox	210,00
31571000	Ecostat E haut débit	512,00
31958000	iControl E	358,00
27385000	DT Raindance E 300 2jet	570,00
28477000 x 6	Douche latérale Raindance 100 S	738,00
27505000	Fixfit	30,00
27581000	Porter'S/Raindance S 100	132,00
TOTAL HT		2.550,00

Raindance Select E 300 2jet ② Version S - Chromé

01800180 x 2	iBox	210,00
15715000	Ecostat S haut débit	530,00
15955000	iControl S	415,00
27385000	DT Raindance E 300 2jet	570,00
28477000 x 6	Douche latérale Raindance 100 S	738,00
27505000	Fixfit	30,00
27581000	Porter'S/Raindance S 100	132,00
TOTAL HT		2.625,00

Raindance Select S 300 2jet ① Version E - Chromé

01800180 x 2	iBox	210,00
31571000	Ecostat E haut débit	512,00
31958000	iControl E	358,00
27378000	DT Raindance S 300 2jet	560,00
28477000 x 6	Douche latérale Raindance 100 S	738,00
27505000	Fixfit	30,00
27581000	Porter'S/Raindance S 100	132,00
TOTAL HT		2.540,00

Raindance S 300 1jet ② Version S - Chromé

01800180 x 2	iBox	210,00
15715000	Ecostat S haut débit	530,00
15955000	iControl S	415,00
27378000	DT Raindance S 300 2jet	560,00
28477000 x 6	Douche latérale Raindance 100 S	738,00
27505000	Fixfit	30,00
27581000	Porter'S/Raindance S 100	132,00
TOTAL HT		2.615,00

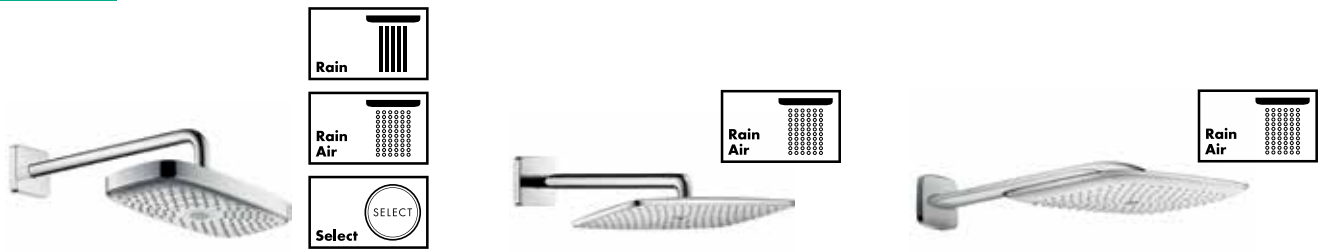

Raindance Select E 300 2jet

Raindance E 360 1jet

PuraVida 400 1jet

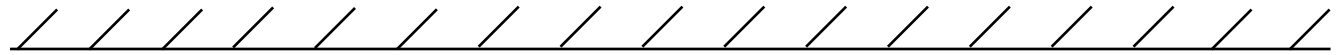

2150 mm*

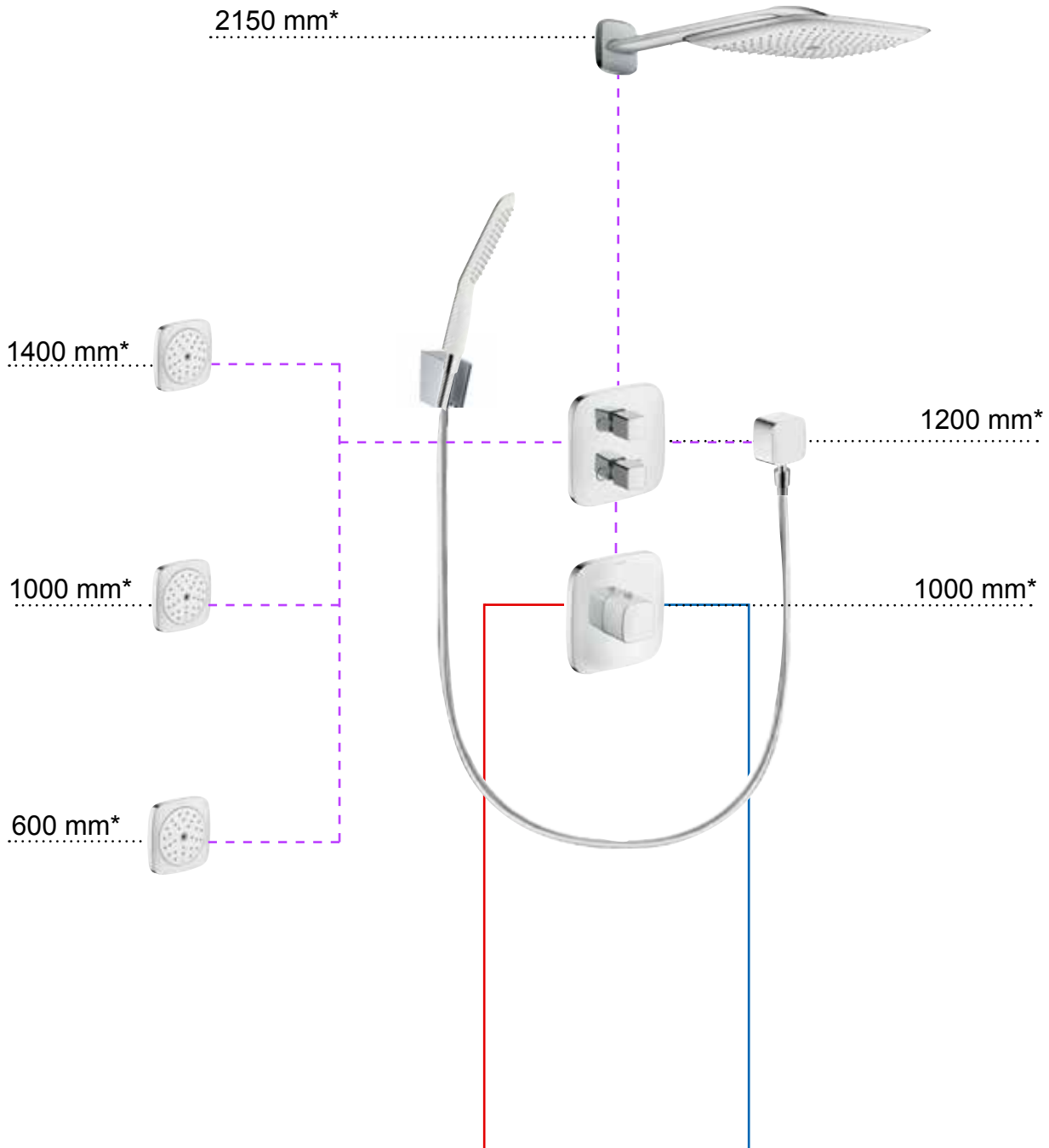

iBox



Thermostatique PuraVida haut débit

iBox



iControl PuraVida

CHIFFRAGE DES SOLUTIONS PuraVida

Raindance Select E 300 2jet Version PuraVida - Blanc/chromé		
---	--	--

01800180 x 2	iBox	210,00
15772400	Thermostatique haut débit	840,00
15777400	iControl PuraVida	410,00
27385400	DT Raindance E 300 2jet	570,00
28430400 x 6	Douche latérale PuraVida	816,00
27414000	Fixfit	44,00
28331000	Porter'S	25,00
28276000	Isiflex 1,60 m	28,00
28558400	Douchette 120 1jet	100,00
TOTAL HT		3.043,00

Raindance E 360 1jet Version PuraVida - Blanc/chromé		
--	--	--

01800180 x 2	iBox	210,00
15772400	Thermostatique haut débit	840,00
15777400	iControl PuraVida	410,00
27376000	DT Raindance E 360 1jet	635,00
28430400 x 6	Douche latérale PuraVida	816,00
27414000	Fixfit	44,00
28331000	Porter'S	25,00
28276000	Isiflex 1,60 m	28,00
28558400	Douchette 120 1jet	100,00
TOTAL HT		3.108,00

PuraVida 400 1jet Version PuraVida - Blanc/chromé		
---	--	--

01800180 x 2	iBox	210,00
15772400	Thermostatique haut débit	840,00
15777400	iControl PuraVida	410,00
27437400	DT PuraVida 400 1jet	1195,00
28430400 x 6	Douche latérale PuraVida	816,00
27414000	Fixfit	44,00
28331000	Porter'S	25,00
28276000	Isiflex 1,60 m	28,00
28558400	Douchette 120 1jet	100,00
TOTAL HT		3.668,00



Raindance Rainfall 150 Stream

Raindance Select S 240 2jet

Douche de tête 24 x 24

2150 mm*

1200 mm*

1000 mm*

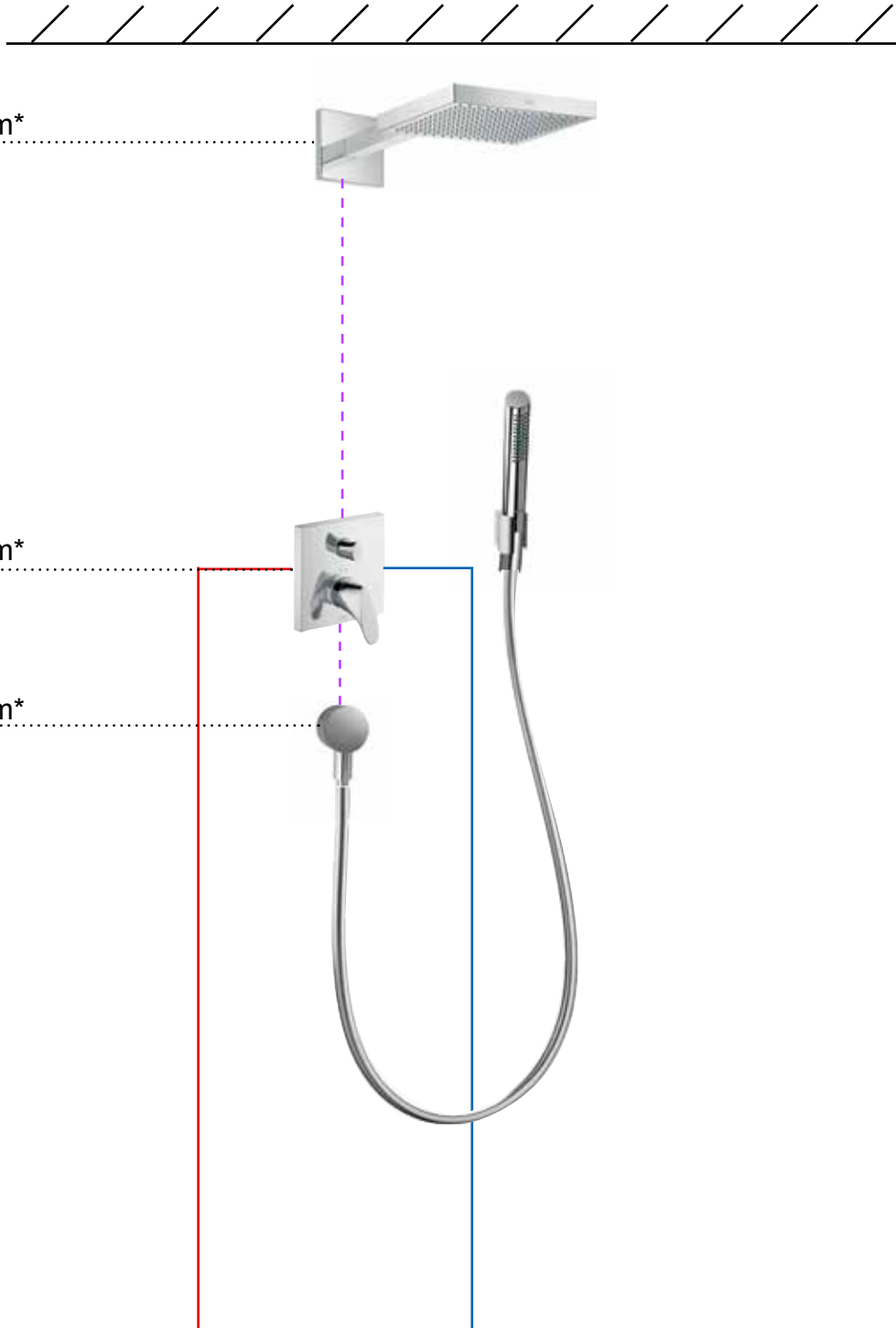

iBox + Mitigeurs

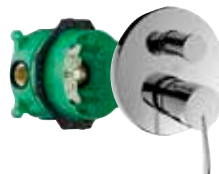

① Starck Puro

② Starck Classic

③ Starck Organic

④ Starck X

CHIFFRAGE DES SOLUTIONS

Axor Starck

Raindance Rainfall Stream

① Mitigeur Starck Puro - Chromé

01800180	iBox	105,00
10416000	Mitigeur Starck Puro	312,00
26443000	DT Rainfall Stream	265,00
27451000	Fixfit	42,00
27515000	Support mural	38,00
28286000	Flexible 1,60 m	63,00
10531000	Douchette tube	100,00
TOTAL HT		925,00

Raindance Select S 240 2jet

① Mitigeur Starck Puro - Chromé

01800180	iBox	105,00
10416000	Mitigeur Starck Puro	312,00
26466000	Raindance Select S 240 2jet	445,00
27451000	Fixfit	42,00
27515000	Support mural	38,00
28286000	Flexible 1,60 m	63,00
10531000	Douchette tube	100,00
TOTAL HT		1.105,00

Douche de tête 24 x 24

① Mitigeur Starck Puro - Chromé

01800180	iBox	105,00
10416000	Mitigeur Starck Puro	312,00
10925000	Douche de tête 24 x 24	1.355,00
10921180	Corps enc. douche tête	237,00
27451000	Fixfit	42,00
27515000	Support mural	38,00
28286000	Flexible 1,60 m	63,00
10531000	Douchette tube	100,00
TOTAL HT		2.252,00

Raindance Rainfall Stream

② Mitigeur Starck Classic - Chromé

01800180	iBox	105,00
10415000	Mitigeur Starck Classic	305,00
26443000	DT Rainfall Stream	265,00
27451000	Fixfit	42,00
27515000	Support mural	38,00
28286000	Flexible 1,60 m	63,00
10531000	Douchette tube	100,00
TOTAL HT		918,00

Raindance Select S 240 2jet

② Mitigeur Starck Classic - Chromé

01800180	iBox	105,00
10415000	Mitigeur Starck Classic	305,00
26466000	Raindance Select S 240 2jet	445,00
27451000	Fixfit	42,00
27515000	Support mural	38,00
28286000	Flexible 1,60 m	63,00
10531000	Douchette tube	100,00
TOTAL HT		1.098,00

Douche de tête 24 x 24

② Mitigeur Starck Classic - Chromé

01800180	iBox	105,00
10415000	Mitigeur Starck Classic	305,00
10925000	Douche de tête 24 x 24	1.355,00
10921180	Corps enc. douche tête	237,00
27451000	Fixfit	42,00
27515000	Support mural	38,00
28286000	Flexible 1,60 m	63,00
10531000	Douchette tube	100,00
TOTAL HT		2.245,00

Raindance Rainfall Stream

③ Mitigeur Starck Organic - Chromé

01800180	iBox	105,00
12415000	Mitigeur Starck Organic	356,00
26443000	DT Rainfall Stream	265,00
27451000	Fixfit	42,00
27515000	Support mural	38,00
28286000	Flexible 1,60 m	63,00
10531000	Douchette tube	100,00
TOTAL HT		969,00

Raindance Select S 240 2jet

③ Mitigeur Starck Organic - Chromé

01800180	iBox	105,00
12415000	Mitigeur Starck Organic	356,00
26466000	Raindance Select S 240 2jet	445,00
27451000	Fixfit	42,00
27515000	Support mural	38,00
28286000	Flexible 1,60 m	63,00
10531000	Douchette tube	100,00
TOTAL HT		1.149,00

Douche de tête 24 x 24

③ Mitigeur Starck Organic - Chromé

01800180	iBox	105,00
12415000	Mitigeur Starck Organic	356,00
10925000	Douche de tête 24 x 24	1.355,00
10921180	Corps enc. douche tête	237,00
27451000	Fixfit	42,00
27515000	Support mural	38,00
28286000	Flexible 1,60 m	63,00
10531000	Douchette tube	100,00
TOTAL HT		2.296,00

Raindance Rainfall Stream

④ Mitigeur Starck X - Chromé

01800180	iBox	105,00
10445000	Mitigeur Starck X	393,00
26443000	DT Rainfall Stream	265,00
27451000	Fixfit	42,00
27515000	Support mural	38,00
28286000	Flexible 1,60 m	63,00
10531000	Douchette tube	100,00
TOTAL HT		1.006,00

Raindance Select S 240 2jet

④ Mitigeur Starck X - Chromé

01800180	iBox	105,00
10445000	Mitigeur Starck X	393,00
26466000	Raindance Select S 240 2jet	445,00
27451000	Fixfit	42,00
27515000	Support mural	38,00
28286000	Flexible 1,60 m	63,00
10531000	Douchette tube	100,00
TOTAL HT		1.186,00

Douche de tête 24 x 24

④ Mitigeur Starck X - Chromé

01800180	iBox	105,00
10445000	Mitigeur Starck X	393,00
10925000	Douche de tête 24 x 24	1.355,00
10921180	Corps enc. douche tête	237,00
27451000	Fixfit	42,00
27515000	Support mural	38,00
28286000	Flexible 1,60 m	63,00
10531000	Douchette tube	100,00
TOTAL HT		2.333,00



Raindance Rainfall 150 Stream

Raindance Select S 240 2jet

Douche de tête 24 x 24

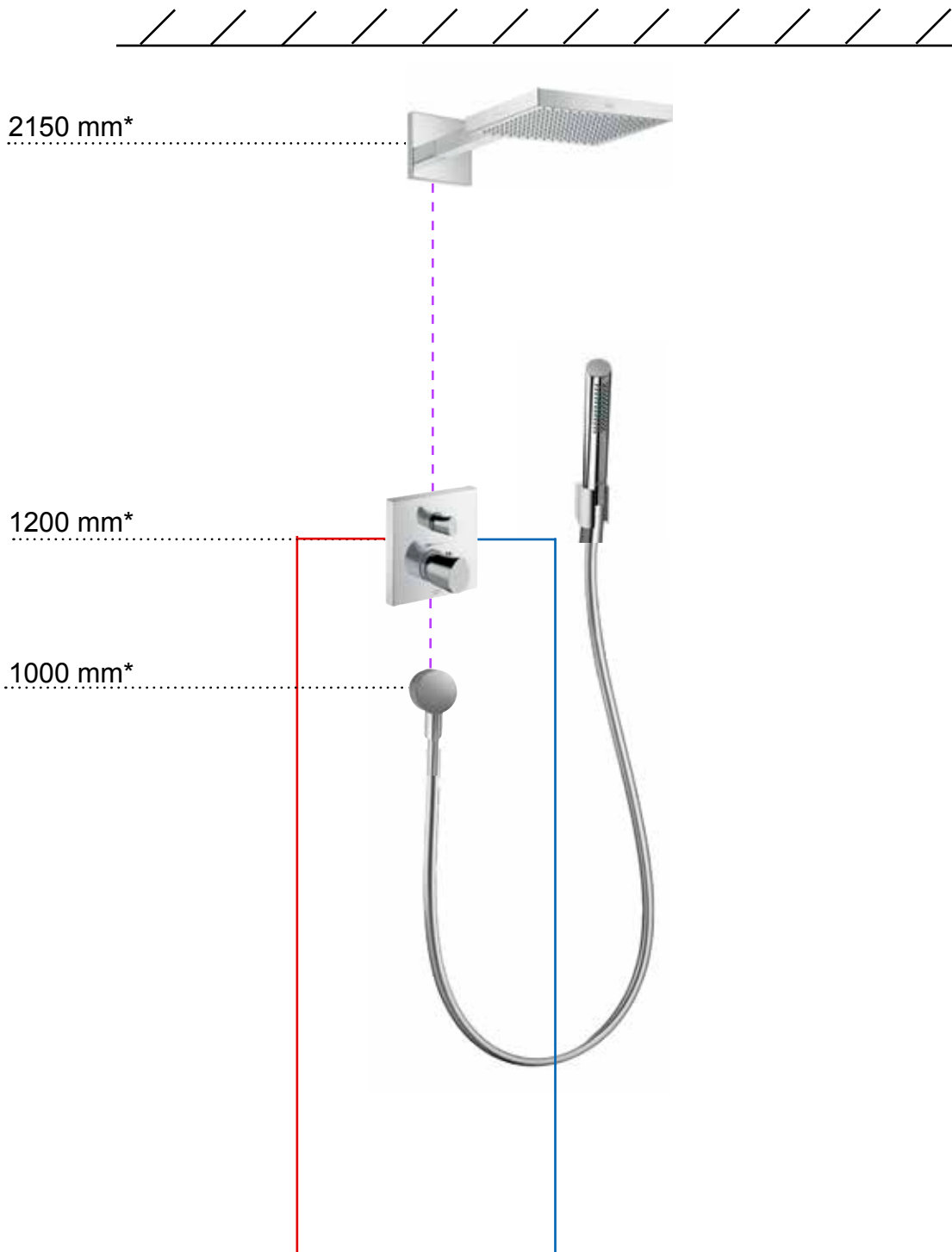

iBox + Thermostatiques



① Starck Organic



② Starck X



③ Starck

CHIFFRAGE DES SOLUTIONS

Axor Starck

Raindance Rainfall Stream - Chromé ① Thermostatique Starck Organic

01800180	iBox	105,00
12716000	Therm. Starck Organic	660,00
26443000	DT Rainfall Stream	265,00
27451000	Fixfit	42,00
27515000	Support mural	38,00
28286000	Flexible 1,60 m	63,00
10531000	Douchette tube	100,00
TOTAL HT		1.273,00

Raindance Select S 240 2jet - Chromé ① Thermostatique Starck Organic

01800180	iBox	105,00
12716000	Therm. Starck Organic	660,00
26466000	Raindance Select S 240 2jet	445,00
27451000	Fixfit	41,00
27515000	Support mural	38,00
28286000	Flexible 1,60 m	63,00
10531000	Douchette tube	100,00
TOTAL HT		1.453,00

Douche de tête 24 x 24 - Chromé ① Thermostatique Starck Organic

01800180	iBox	105,00
12716000	Therm. Starck Organic	660,00
10925000	Douche de tête 24 x 24	1.355,00
10921180	Corps enc. douche tête	237,00
27451000	Fixfit	42,00
27515000	Support mural	38,00
28286000	Flexible 1,60 m	63,00
10531000	Douchette tube	100,00
TOTAL HT		2.600,00

Raindance Rainfall Stream - Chromé ② Thermostatique Starck X

01800180	iBox	105,00
10726000	Thermostat. Starck X	800,00
26443000	DT Rainfall Stream	265,00
27451000	Fixfit	42,00
27515000	Support mural	38,00
28286000	Flexible 1,60 m	63,00
10531000	Douchette tube	100,00
TOTAL HT		1.413,00

Raindance Select S 240 2jet - Chromé ② Thermostatique Starck X

01800180	iBox	105,00
10726000	Thermostat. Starck X	800,00
26466000	Raindance Select S 240 2jet	445,00
27451000	Fixfit	42,00
27515000	Support mural	38,00
28286000	Flexible 1,60 m	63,00
10531000	Douchette tube	100,00
TOTAL HT		1.593,00

Douche de tête 24 x 24 - Chromé ② Thermostatique Starck X

01800180	iBox	105,00
10726000	Thermostat. Starck X	800,00
10925000	Douche de tête 24 x 24	1.355,00
10921180	Corps enc. douche tête	237,00
27451000	Fixfit	42,00
27515000	Support mural	38,00
28286000	Flexible 1,60 m	63,00
10531000	Douchette tube	100,00
TOTAL HT		2.740,00

Raindance Rainfall Stream - Chromé ③ Thermostatique Starck

01800180	iBox	105,00
10720000	Thermostatique Starck	827,00
26443000	DT Rainfall Stream	265,00
27451000	Fixfit	42,00
27515000	Support mural	38,00
28286000	Flexible 1,60 m	63,00
10531000	Douchette tube	100,00
TOTAL HT		1.440,00

Raindance Select S 240 2jet - Chromé ③ Thermostatique Starck

01800180	iBox	105,00
10720000	Thermostatique Starck	827,00
26466000	Raindance Select S 240 2jet	445,00
27451000	Fixfit	42,00
27515000	Support mural	38,00
28286000	Flexible 1,60 m	63,00
10531000	Douchette tube	100,00
TOTAL HT		1.620,00

Douche de tête 24 x 24 - Chromé ③ Thermostatique Starck

01800180	iBox	105,00
10720000	Thermostatique Starck	827,00
10925000	Douche de tête 24 x 24	1.355,00
10921180	Corps enc. douche tête	237,00
27451000	Fixfit	42,00
27515000	Support mural	38,00
28286000	Flexible 1,60 m	63,00
10531000	Douchette tube	100,00
TOTAL HT		2.767,00



Douche de tête 24 x 24



Douche de tête 240 Air

2150 mm*

1200 mm*

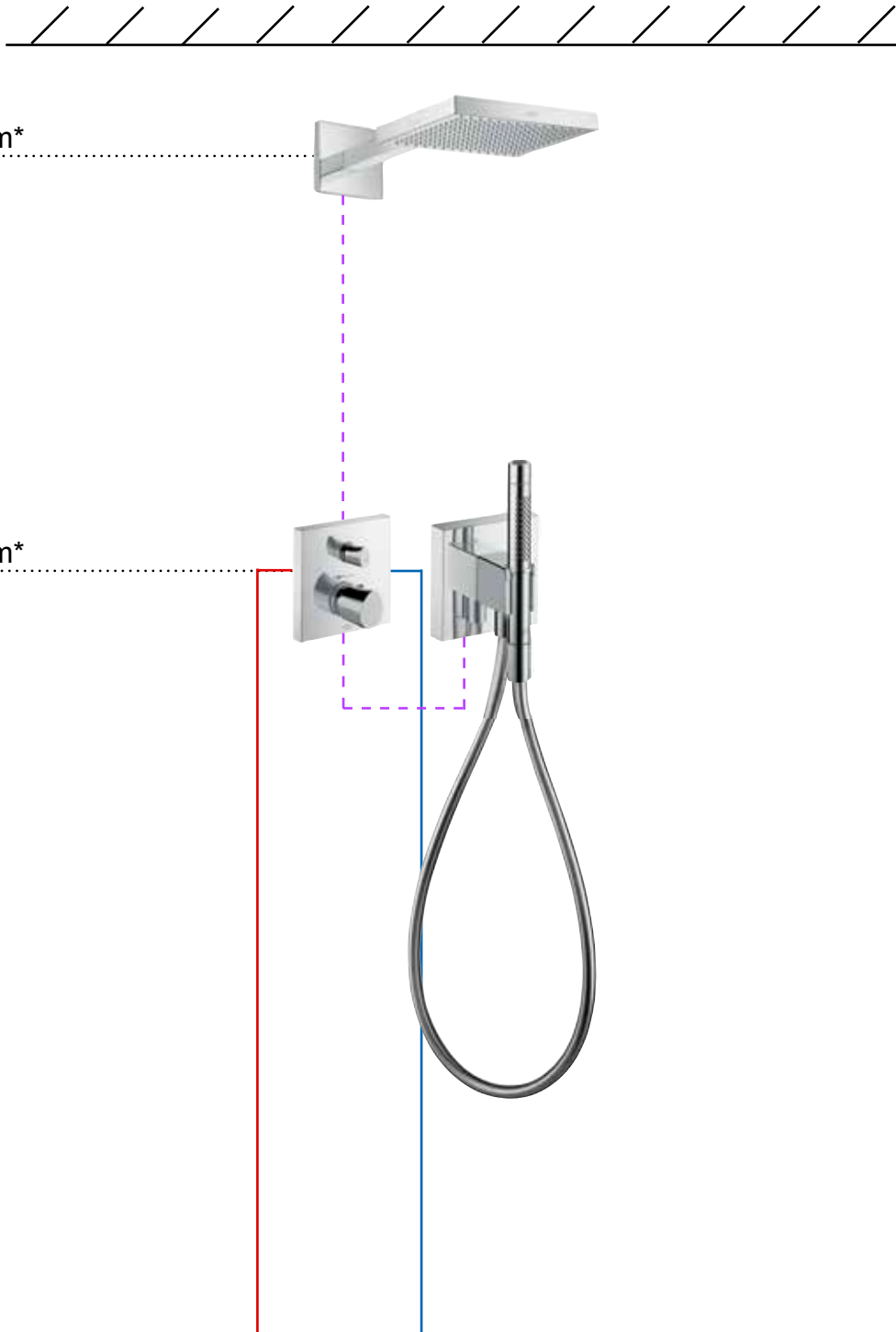

iBox + Thermostatiques



① Starck Organic



② Starck X



③ Starck

CHIFFRAGE DES SOLUTIONS

Axor Starck

Douche de tête 24 x 24 - Chromé ① Thermostatique Starck Organic

01800180	iBox	105,00
12716000	Therm. Starck Organic	660,00
10925000	Douche de tête 24 x 24	1.355,00
10921180	Corps enc. douche tête	237,00
12626000	Set Porter douchette	393,00
TOTAL HT		2.750,00

Douche de tête 240 Air - Chromé ① Thermostatique Starck Organic

01800180	iBox	105,00
12716000	Therm. Starck Organic	660,00
27494000	Douche de tête 240 Air	640,00
27413000	Bras de douche 389	85,00
12626000	Set Porter douchette	393,00
TOTAL HT		1.883,00

Douche de tête 24 x 24 - Chromé ② Thermostatique Starck X

01800180	iBox	105,00
10726000	Thermostat. Starck X	800,00
10925000	Douche de tête 24 x 24	1.355,00
10921180	Corps enc. douche tête	237,00
12626000	Set Porter douchette	393,00
TOTAL HT		2.890,00

Douche de tête 240 Air - Chromé ② Thermostatique Starck X

01800180	iBox	105,00
10726000	Thermostat. Starck X	800,00
27494000	Douche de tête 240 Air	640,00
27413000	Bras de douche 389	85,00
12626000	Set Porter douchette	393,00
TOTAL HT		2.023,00

Douche de tête 24 x 24 - Chromé ③ Thermostatique Starck

01800180	iBox	105,00
10720000	Thermostatique Starck	827,00
10925000	Douche de tête 24 x 24	1.355,00
10921180	Corps enc. douche tête	237,00
12626000	Set Porter douchette	393,00
TOTAL HT		2.917,00

Douche de tête 240 Air - Chromé ③ Thermostatique Starck

01800180	iBox	105,00
10720000	Thermostatique Starck	827,00
27494000	Douche de tête 240 Air	640,00
27413000	Bras de douche 389	85,00
12626000	Set Porter douchette	393,00
TOTAL HT		2.050,00



Citterio 180 1jet



Raindance S 300 1jet



Raindance Rainfall 150 Stream

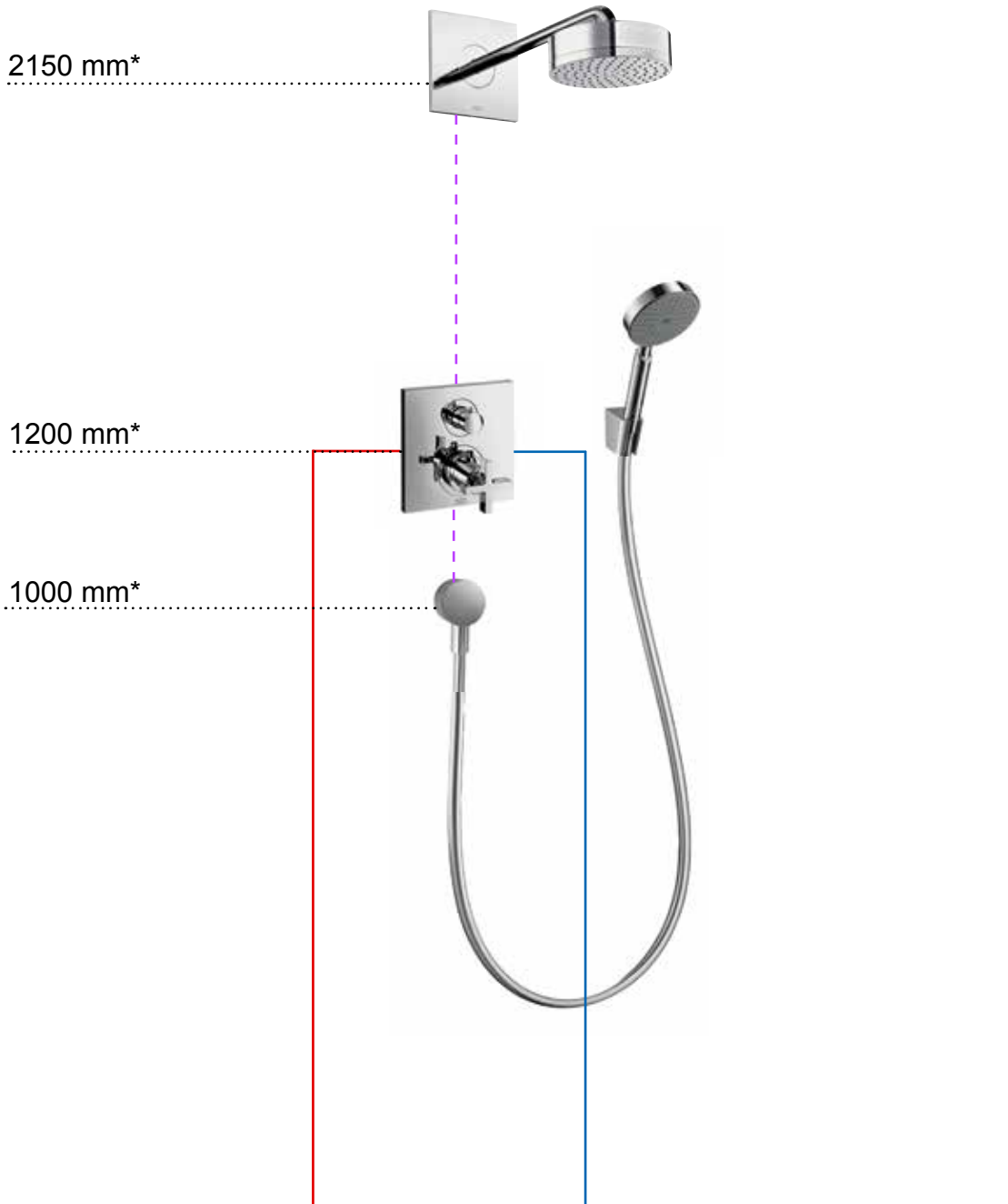
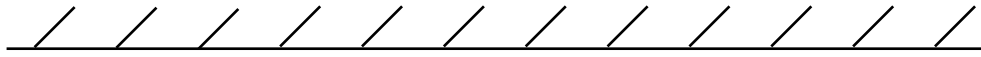

① Mitigeur



② Thermostatique
Poignée manette



③ Thermostatique
Poignée croisillon

CHIFFRAGE DES SOLUTIONS Axor Citterio

Citterio 180 1jet - Chromé ① Mitigeur Citterio

01800180	iBox	105,00
39455000	Mitigeur Citterio	428,00
28489000	DT Citterio 180 1jet	585,00
27409000	Bras de douche 241	61,00
27419000	Plaque murale	130,00
27451000	Fixfit	42,00
27581000	Porter'S/Raidance S	132,00
TOTAL HT		1.483,00

Citterio 180 1jet - Chromé ② Thermostatique manette

01800180	iBox	105,00
39720000	Therm. manette Citterio	870,00
28489000	DT Citterio 180 1jet	585,00
27409000	Bras de douche 241	61,00
27419000	Plaque murale	130,00
27451000	Fixfit	42,00
27581000	Porter'S/Raidance S	130,00
TOTAL HT		1.925,00

Citterio 180 1jet - Chromé ③ Thermostatique croisillon

01800180	iBox	105,00
39725000	Therm. croisil. Citterio	870,00
28489000	DT Citterio 180 1jet	585,00
27409000	Bras de douche 241	61,00
27419000	Plaque murale	130,00
27451000	Fixfit	42,00
27581000	Porter'S/Raidance S	130,00
TOTAL HT		1.925,00

Raidance S 300 1jet - Chromé ① Mitigeur Citterio

01800180	iBox	105,00
39455000	Mitigeur Citterio	428,00
27493000	Raidance S 300 1jet	680,00
27419000	Plaque murale	130,00
27451000	Fixfit	42,00
27581000	Porter'S/Raidance S	132,00
TOTAL HT		1.517,00

Raidance S 300 1jet - Chromé ② Thermostatique manette

01800180	iBox	105,00
39720000	Therm. manette Citterio	870,00
27493000	Raidance S 300 1jet	680,00
27419000	Plaque murale	130,00
27451000	Fixfit	42,00
27581000	Porter'S/Raidance S	132,00
TOTAL HT		1.959,00

Raidance S 300 1jet - Chromé ③ Thermostatique croisillon

01800180	iBox	105,00
39725000	Therm. croisil. Citterio	870,00
27493000	Raidance S 300 1jet	680,00
27419000	Plaque murale	130,00
27451000	Fixfit	42,00
27581000	Porter'S/Raidance S	132,00
TOTAL HT		1.959,00

Raidance Rainfall Stream - Chromé ① Mitigeur Citterio

01800180	iBox	105,00
39455000	Mitigeur Citterio	428,00
26443000	DT Rainfall Stream	265,00
27451000	Fixfit	42,00
27581000	Porter'S/Raidance S	132,00
TOTAL HT		972,00

Raidance Rainfall Stream - Chromé ② Thermostatique manette

01800180	iBox	105,00
39720000	Therm. manette Citterio	870,00
26443000	DT Rainfall Stream	265,00
27451000	Fixfit	42,00
27581000	Porter'S/Raidance S	132,00
TOTAL HT		1.414,00

Raidance Rainfall Stream - Chromé ③ Thermostatique croisillon

01800180	iBox	105,00
39725000	Therm. croisil. Citterio	870,00
26443000	DT Rainfall Stream	265,00
27451000	Fixfit	42,00
27581000	Porter'S/Raidance S	132,00
TOTAL HT		1.414,00

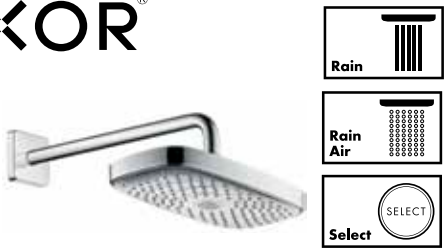

Raindance Select E 300 2jet



Raindance Select S 300 2jet



Douche de tête 3jet

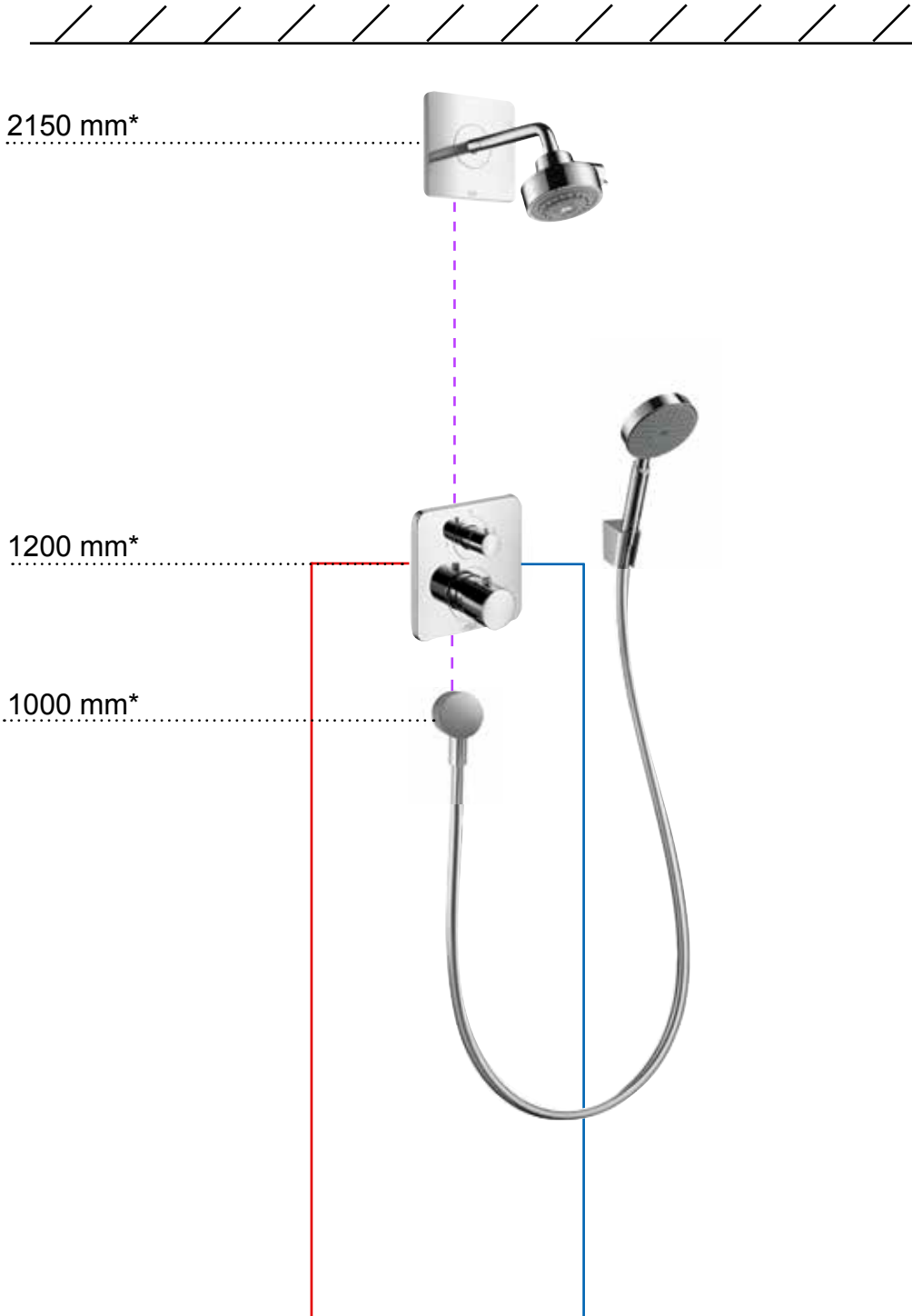

① Mitigeur



② Thermostatique

CHIFFRAGE DES SOLUTIONS Axor Citterio M

Raindance Select E 300 2jet ① Mitigeur - Chromé

01800180	iBox	105,00
34425000	Mitigeur	347,00
27385000	Raindance Select E 300 2jet	570,00
27451000	Fixfit	42,00
27581000	Porter'S/Raidance S	132,00
TOTAL HT		1.196,00

Raindance Select E 300 2jet ② Thermostatique - Chromé

01800180	iBox	105,00
34725000	Thermostatique	740,00
27385000	Raindance Select E 300 2jet	570,00
27451000	Fixfit	42,00
27581000	Porter'S/Raidance S	132,00
TOTAL HT		1.589,00

Raindance Select S 300 2jet ① Mitigeur - Chromé

01800180	iBox	105,00
34425000	Mitigeur	347,00
27378000	Raindance Select S 300 2jet	560,00
27451000	Fixfit	42,00
27581000	Porter'S/Raidance S	132,00
TOTAL HT		1.186,00

Raindance Select S 300 2jet ② Thermostatique - Chromé

01800180	iBox	105,00
34725000	Thermostatique	740,00
27378000	Raindance Select S 300 2jet	560,00
27451000	Fixfit	42,00
27581000	Porter'S/Raidance S	132,00
TOTAL HT		1.579,00

Douche de tête 3jet ① Mitigeur - Chromé

01800180	iBox	105,00
34425000	Mitigeur	347,00
39740000	Douche de tête 3jet	554,00
27412000	Bras de douche 230	61,00
34612000	Plaque de recouvrement	106,00
27451000	Fixfit	42,00
27581000	Porter'S/Raidance S	132,00
TOTAL HT		1.347,00

Douche de tête 3jet ② Thermostatique - Chromé

01800180	iBox	105,00
34725000	Thermostatique	740,00
39740000	Douchet de tête 3jet	554,00
27412000	Bras de douche 230	61,00
34612000	Plaque de recouvrement	106,00
27451000	Fixfit	42,00
27581000	Porter'S/Raidance S	132,00
TOTAL HT		1.740,00



Raindance Select E 300 2jet

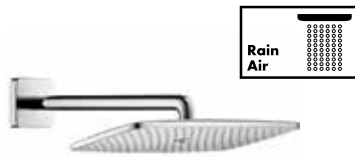

Raindance E 360 1jet

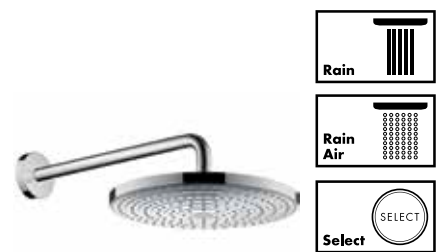

Raindance Select S 300 2jet

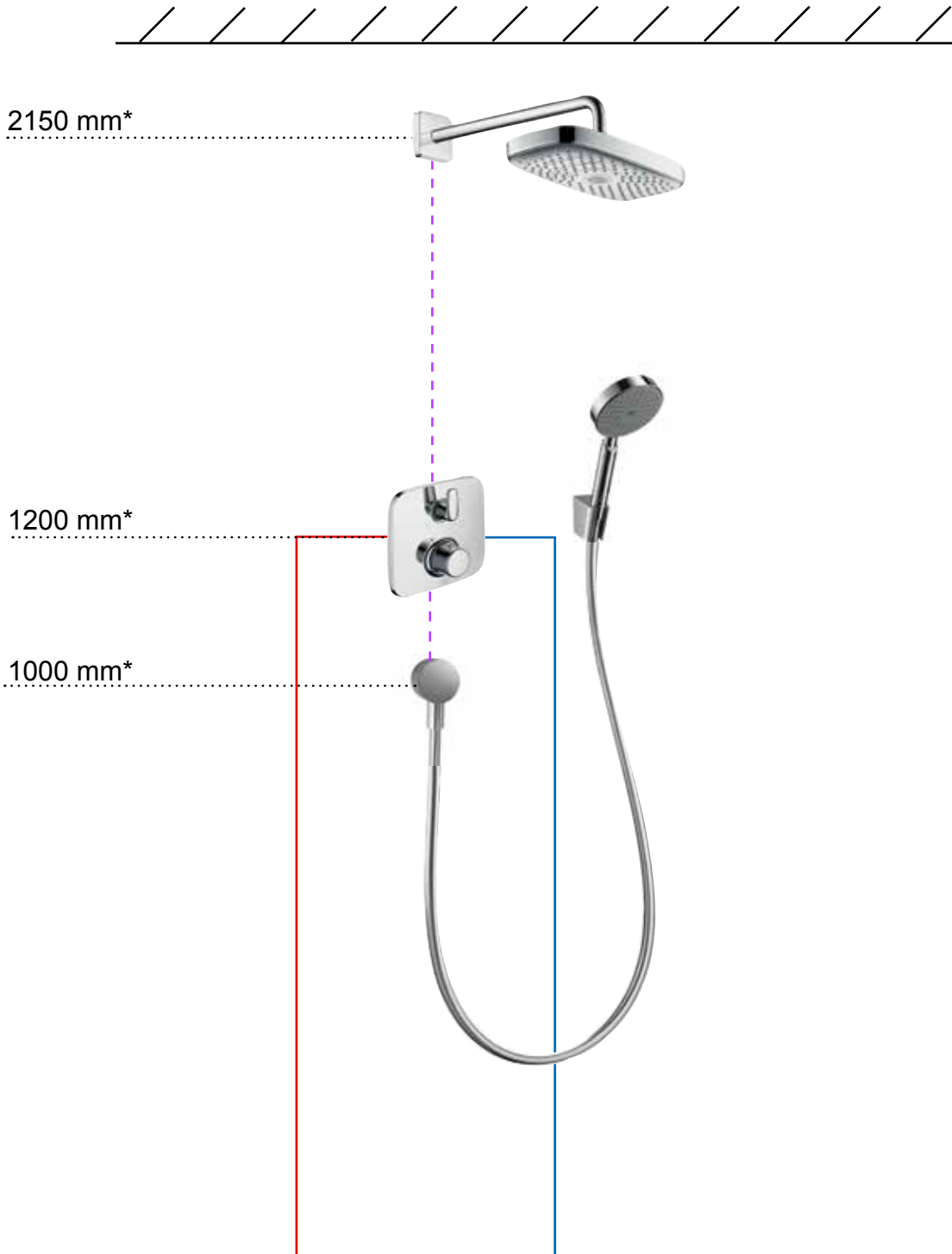

① Axor Bouroullec



② Axor Uno²

CHIFFRAGE DES SOLUTIONS

Axor Bouroullec - Axor Uno²

Raindance Select E 300 2jet ① Axor Bouroullec - Chromé

01800180	iBox	105,00
19706000	Thermostatique	695,00
27385000	Raindance E 300 2jet	570,00
27451000	Fixfit	42,00
27581000	Porter'S/Raidance S	132,00
TOTAL HT		1.544,00

Raindance Select E 300 2jet ② Axor Uno² - Chromé

01800180	iBox	105,00
38720000	Thermostatique	840,00
27385000	Raindance E 300 2jet	570,00
27451000	Fixfit	42,00
27581000	Porter'S/Raidance S	132,00
TOTAL HT		1.689,00

Raindance E 360 1jet ① Axor Bouroullec - Chromé

01800180	iBox	105,00
19706000	Thermostatique	695,00
27376000	Raindance E 360 1jet	635,00
27451000	Fixfit	42,00
27581000	Porter'S/Raidance S	132,00
TOTAL HT		1.609,00

Raindance E 360 1jet ② Axor Uno² - Chromé

01800180	iBox	105,00
38720000	Thermostatique	840,00
27376000	Raindance E 360 1jet	635,00
27451000	Fixfit	42,00
27581000	Porter'S/Raidance S	132,00
TOTAL HT		1.754,00

Raindance Select S 300 2jet ① Axor Bouroullec - Chromé

01800180	iBox	105,00
19706000	Thermostatique	695,00
27378000	Raindance Select S 300 2jet	560,00
27451000	Fixfit	42,00
27581000	Porter'S/Raidance S	132,00
TOTAL HT		1.534,00

Raindance Select S 300 2jet ② Axor Uno² - Chromé

01800180	iBox	105,00
38720000	Thermostatique	840,00
27378000	Raindance Select S 300 2jet	560,00
27451000	Fixfit	42,00
27581000	Porter'S/Raidance S	132,00
TOTAL HT		1.679,00



Raindance Select E 300 2jet



Raindance E 360 1jet

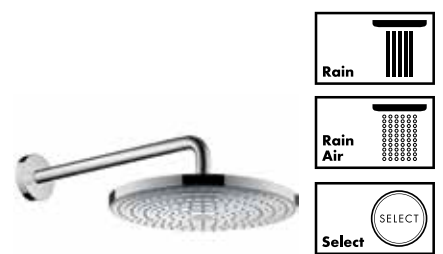

Raindance Select S 300 2jet

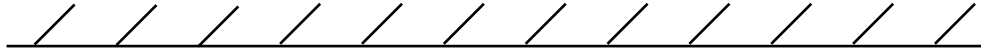

2150 mm*



1200 mm*



1000 mm*



iBox



① Axor Urquiola

iBox



② Axor Massaud

CHIFFRAGE DES SOLUTIONS

Axor Urquiola - Axor Massaud

Raindance Select E 300 2jet ① Axor Urquiola - Chromé

01800180	iBox	105,00
11733000	Thermostatique	791,00
27385000	Raindance E 300 2jet	570,00
27451000	Fixfit	42,00
27581000	Porter'S/Raidance S	132,00
TOTAL HT		1.640,00

Raindance Select E 300 2jet ② Axor Massaud - Chromé

01800180	iBox	105,00
18750000	Thermostatique	1028,00
27385000	Raindance E 300 2jet	570,00
27451000	Fixfit	42,00
27581000	Porter'S/Raidance S	132,00
TOTAL HT		1.877,00

Raindance E 360 1jet ① Axor Urquiola - Chromé

01800180	iBox	105,00
11733000	Thermostatique	791,00
27376000	Raindance E 360 1jet	635,00
27451000	Fixfit	42,00
27581000	Porter'S/Raidance S	132,00
TOTAL HT		1.705,00

Raindance E 360 1jet ② Axor Massaud - Chromé

01800180	iBox	105,00
18750000	Thermostatique	1028,00
27376000	Raindance E 360 1jet	635,00
27451000	Fixfit	42,00
27581000	Porter'S/Raidance S	132,00
TOTAL HT		1.942,00

Raindance Select S 300 2jet ① Axor Urquiola - Chromé

01800180	iBox	105,00
11733000	Thermostatique	791,00
27378000	Raindance Select S 300 2jet	560,00
27451000	Fixfit	42,00
27581000	Porter'S/Raidance S	132,00
TOTAL HT		1.630,00

Raindance Select S 300 2jet ② Axor Massaud - Chromé

01800180	iBox	105,00
18750000	Thermostatique	1028,00
27378000	Raindance Select S 300 2jet	560,00
27451000	Fixfit	42,00
27581000	Porter'S/Raidance S	132,00
TOTAL HT		1.867,00

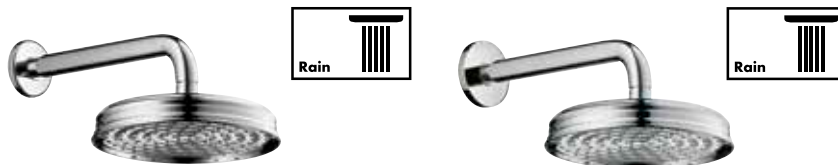

Douche de tête 180

Douche de tête 240

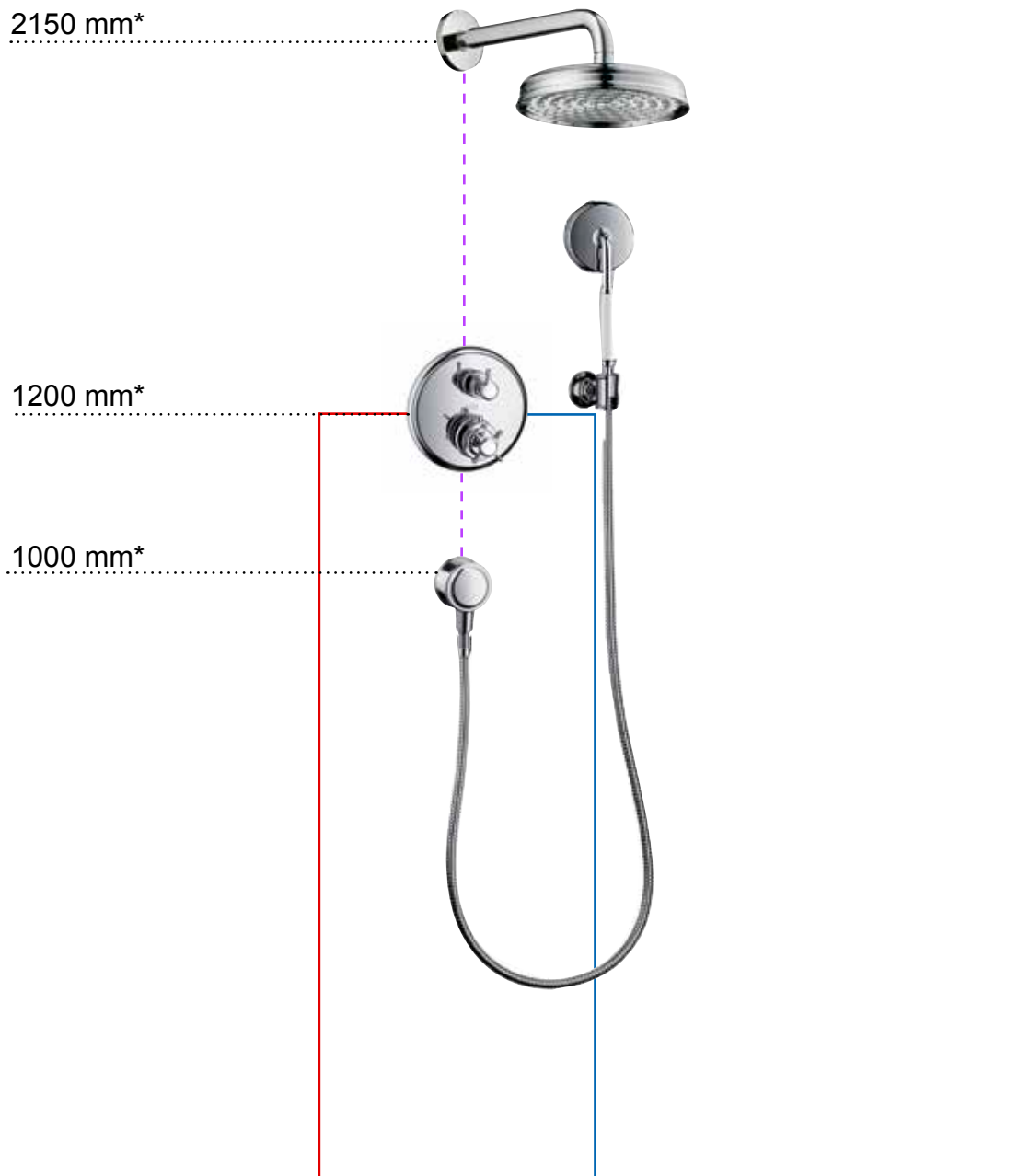

① Axor Montreux



② Axor Carlton
Poignée manette



③ Axor Carlton
Poignée croisillon

CHIFFRAGE DES SOLUTIONS Axor Montreux - Axor Carlton

Douche de tête 180 ① Axor Montreux - Chromé

01800180	iBox	105,00
16820000	Thermostatique	783,00
28487000	Douche de tête 180	537,00
27413000	Bras de douche 389	85,00
16884000	Fixfit	42,00
28116000	Flexible 1,60 m	80,00
16325000	Porter	98,00
16320000	Douchette	194,00
TOTAL HT		1.924,00

Douche de tête 180 ② Axor Carlton manette - Chromé

01800180	iBox	105,00
17720000	Thermostatique	895,00
28487000	Douche de tête 180	537,00
27413000	Bras de douche 389	85,00
16884000	Fixfit	42,00
28116000	Flexible 1,60 m	80,00
16325000	Porter	98,00
16320000	Douchette	194,00
TOTAL HT		2.036,00

Citterio 180 1jet ③ Axor Carlton croisillon - Chromé

01800180	iBox	105,00
17725000	Thermostatique	895,00
28487000	Douche de tête 180	537,00
27413000	Bras de douche 389	85,00
16884000	Fixfit	42,00
28116000	Flexible 1,60 m	80,00
16325000	Porter	98,00
16320000	Douchette	194,00
TOTAL HT		2.036,00

Douche de tête 240 ① Axor Montreux - Chromé

01800180	iBox	105,00
16820000	Thermostatique	783,00
28474000	Douche de tête 240	724,00
27413000	Bras de douche 389	85,00
16884000	Fixfit	42,00
28116000	Flexible 1,60 m	80,00
16325000	Porter	98,00
16320000	Douchette	194,00
TOTAL HT		2.111,00

Douche de tête 240 ② Axor Carlton manette - Chromé

01800180	iBox	105,00
17720000	Thermostatique	895,00
28474000	Douche de tête 240	724,00
27413000	Bras de douche 389	85,00
16884000	Fixfit	42,00
28116000	Flexible 1,60 m	80,00
16325000	Porter	98,00
16320000	Douchette	194,00
TOTAL HT		2.223,00

Douche de tête 240 ③ Axor Carlton croisillon - Chromé

01800180	iBox	105,00
17725000	Thermostatique	895,00
28474000	Douche de tête 240	724,00
27413000	Bras de douche 389	85,00
16884000	Fixfit	42,00
28116000	Flexible 1,60 m	80,00
16325000	Porter	98,00
16320000	Douchette	194,00
TOTAL HT		2.223,00



Douche de tête 24 x 24



Douche de tête lame d'eau

2150 mm*



raccordement 3/4

1200 mm*

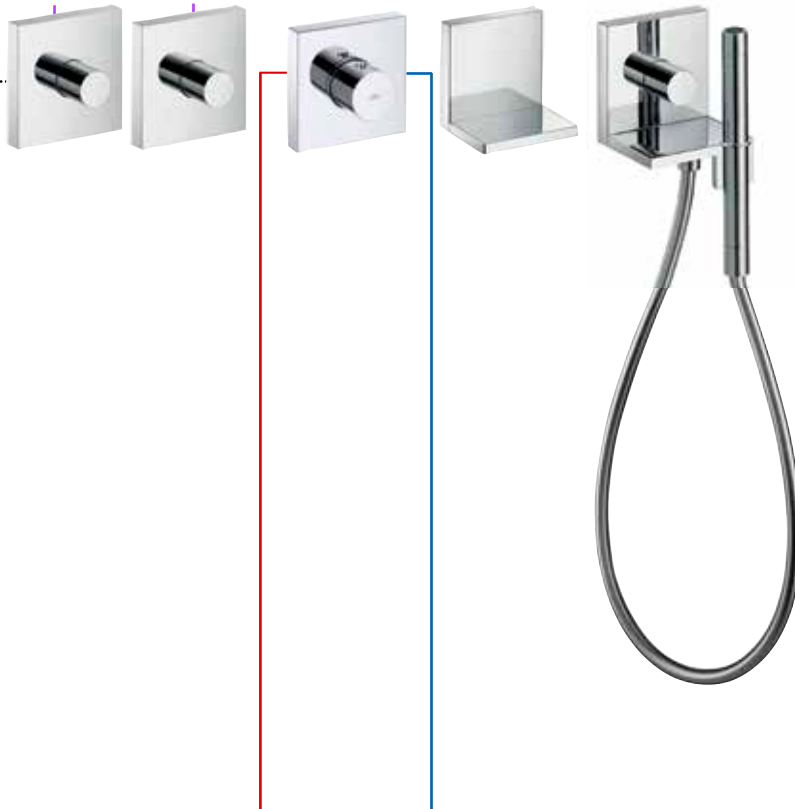

CHIFFRAGE SOLUTION Axor ShowerCollection

Douche de tête 24 x 24 + douche de tête lame d'eau Ensemble Axor ShowerCollection - Chromé		
10925000	Douche de tête 24 x 24	1.355,00
10942000	Lame d'eau	677,00
10972000 x 2	Robinet d'arrêt	454,00
10971180 x 2	Corps enc. robinet arrêt	246,00
10755000	Thermostatique	685,00
10754180	Corps enc. thermostatique	350,00
40872000	Tablette courte	424,00
40877180	Corps enc. tablette	168,00
10651000	Module rob. arrêt + douchette	780,00
10650180	Corps enc. module RA + douchette	210,00
TOTAL HT		5.349,00

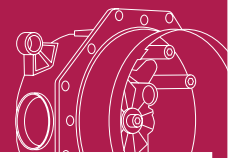

iBox® universal

Variante de pose pour
3 fonctions

Pose pour 3 fonctions : Select

Diagramme de débit

Douche de tête 3jet
39740000



Diagramme de débit

Douchette à main Raindance Select S 120 3jet
26520000

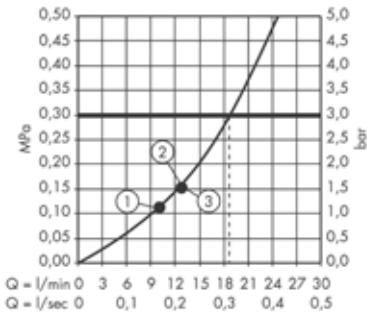
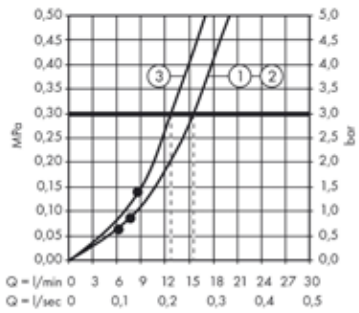

A partir de • le fonctionnement est garanti

Legende

- ① RainAir
- ② Rain
- ③ Whirl

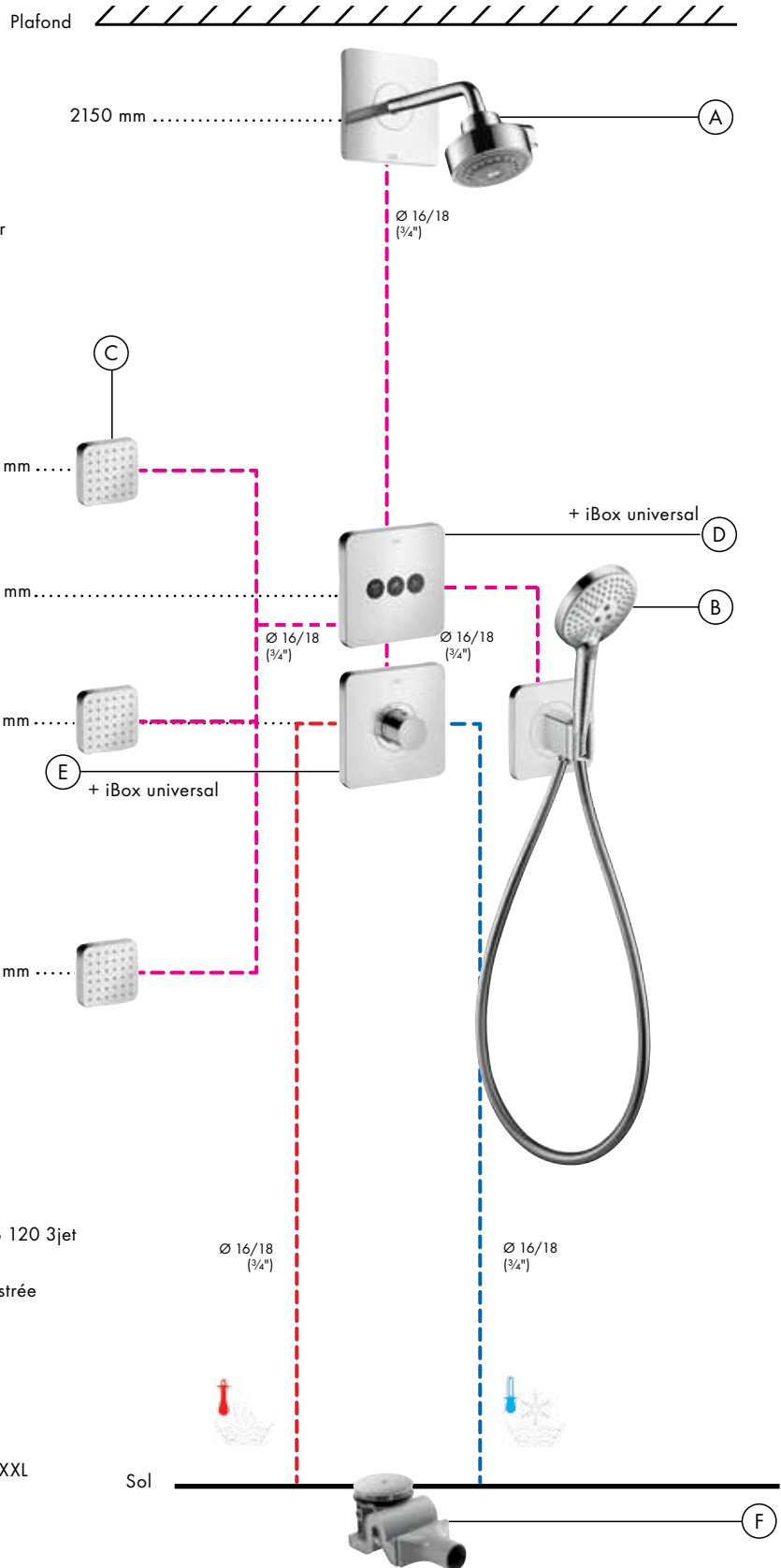

Composants

Montage des robinetteries

- D iBox universal
01800180
Robinet Axor ShowerSelect
pour 3 fonctions
36773000
- E iBox universal
01800180
Axor ShowerSelect
Thermostatique
36711000

Installation de la douche

- A Douche de tête 3jet
39740000
Plaque murale 12x12cm
36725000
Bras de douche 230 mm
27412000
- B Douchette Raindance Select S 120 3jet
26530000
Porter pour alimentation encastrée
36724000
Flexible Isiflex 1,60m
28276000
- C Douche latérale 12x12cm x 3
36822000
- F Système de vidage Raindrain XXL
60067000

TOTAL : 3.060 €

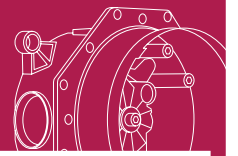

iBox® universal

Variante de pose pour
3 fonctions

Pose pour 3 fonctions : Select

Diagramme de débit

Douche de tête 3jet
28494000



Diagramme de débit

Douchette à main Raindance Select S 120 3jet
26520000

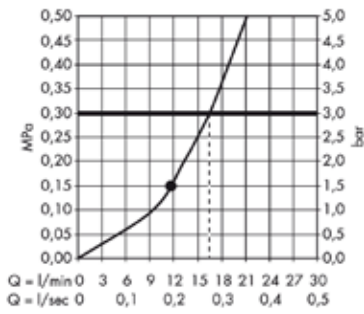
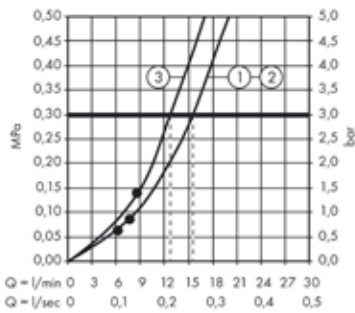

A partir de • le fonctionnement est garanti

Plafond

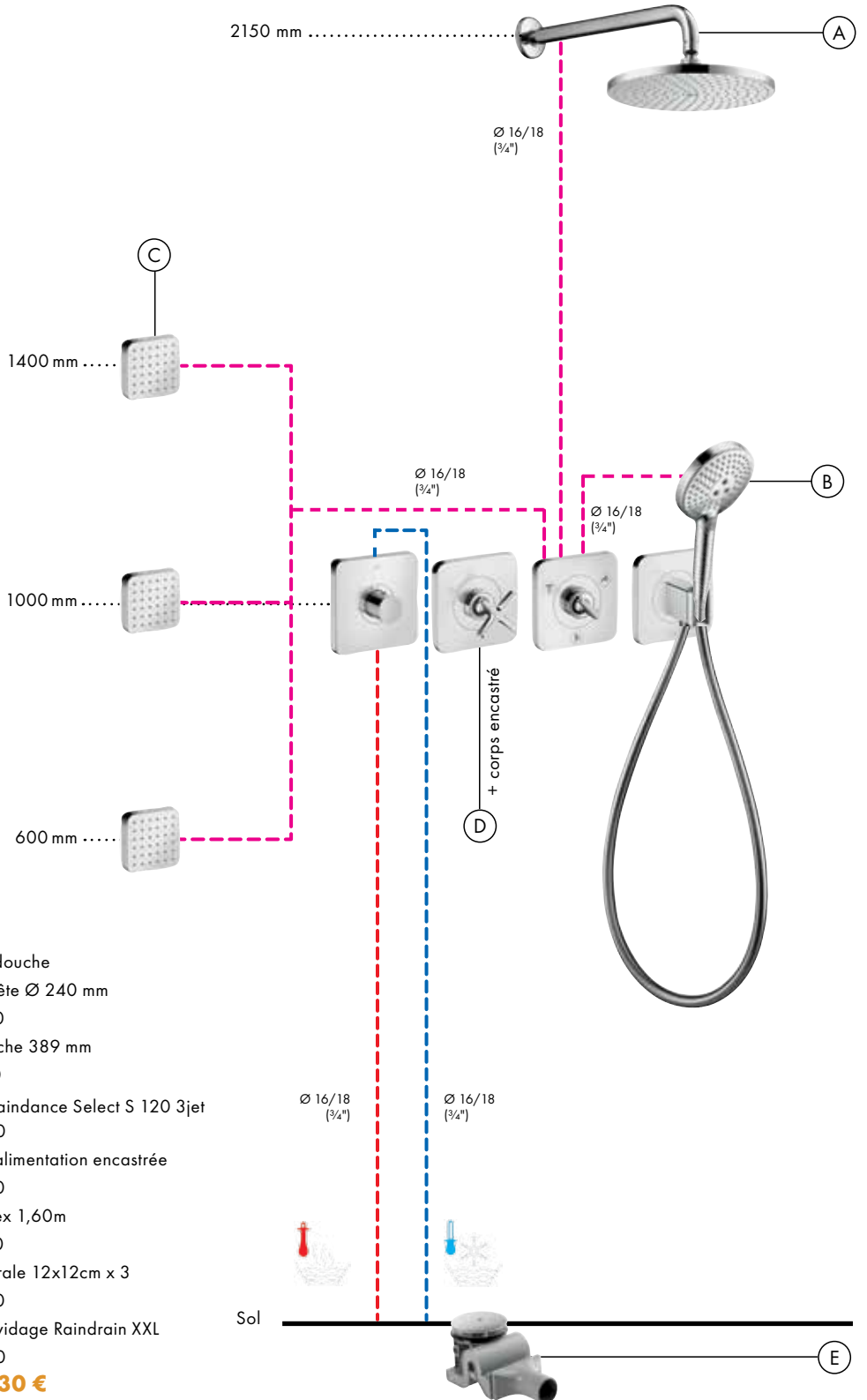

Composants

Montage des robinetteries

(D) Corps encastré

36701180

Module thermostatique

avec robinet d'arrêt et

3 sorties

36704000

Installation de la douche

(A) Douche de tête Ø 240 mm

28494000

Bras de douche 389 mm

27413000

(B) Douchette Raindance Select S 120 3jet

26530000

Porter pour alimentation encastrée

36724000

Flexible Isiflex 1,60m

28276000

(C) Douche latérale 12x12cm x 3

36822000

(E) Système de vidage Raindrain XXL

60067000

TOTAL : 3.330 €

Les solutions pour la douche

ShowerSelect®: La révolution du monde encastré

Design et fonction vont de pair sur les nouveaux sets de finition ShowerSelect. Tous les systèmes de commandes ont évolué d'une action de rotation vers un mouvement de pression : le changement de jet ou de commande se fait maintenant en un simple clic ! Pour plus d'informations sur la technologie Select, rendez-vous sur : www.pro.hansgrohe.fr/select



ShowerSelect®: La révolution du monde encastré

Design et fonction vont de pair sur les nouveaux sets de finition ShowerSelect. Tous les systèmes de commandes ont évolué d'une action de rotation vers un mouvement de pression : le changement de jet ou de commande se fait maintenant en un simple clic ! Pour plus d'informations sur la technologie Select, rendez-vous sur : www.pro.hansgrohe.fr/select



Intuitif:

Les touches de sélection permettent un fonctionnement simple et pratique pour un champ d'utilisation plus large.



Confortable:

Avec sa poignée ergonomique, la température désirée se règle avec précision.



Facile d'entretien:

Grâce à sa forme rectangulaire et plane, le ShowerSelect est facile à nettoyer.



Economique:

L'arrêt de l'eau facilité grâce à la simple pression du bouton Select permet de réaliser des économies importantes d'eau et d'énergie.

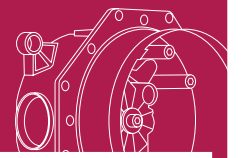

iBox® universal

Variante de pose pour
2 fonctions

Pose pour 2 fonctions : Select

Diagramme de débit

Douche de tête Croma Select E 180 2jet
26524000

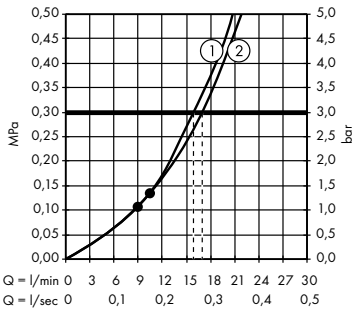

Légende

- ① RainAir
- ② IntenseRain

Diagramme de débit

Douchette à main Raindance E 120 3jet
26520000

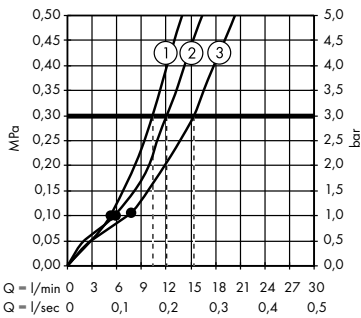

Légende

- ① TurboRain
- ② IntenseRain
- ③ Rain

A partir de • le fonctionnement est garanti

Composants

Robinetteries

- ⓑ iBox universal
01800180
ShowerSelect Thermostatique
15763000



Alternative:
Thermostatique E avec
robinet d'arrêt intégré
15708000

TOTAL : 1.035 €

Autres alternatives possibles.

Douches

- Ⓐ Douche de tête Croma Select
E 180 2jet blanc/chromé
26524400
Bras de douche 389 mm
27446000
- ⓒ Set Porter'S/Croma Select E
110 Vario blanc/chromé
26413400
- Ⓓ Coude de raccordement FixFit
26457000
- Ⓔ Système de vidage Staro 90
60056000

TOTAL : 1.195 €

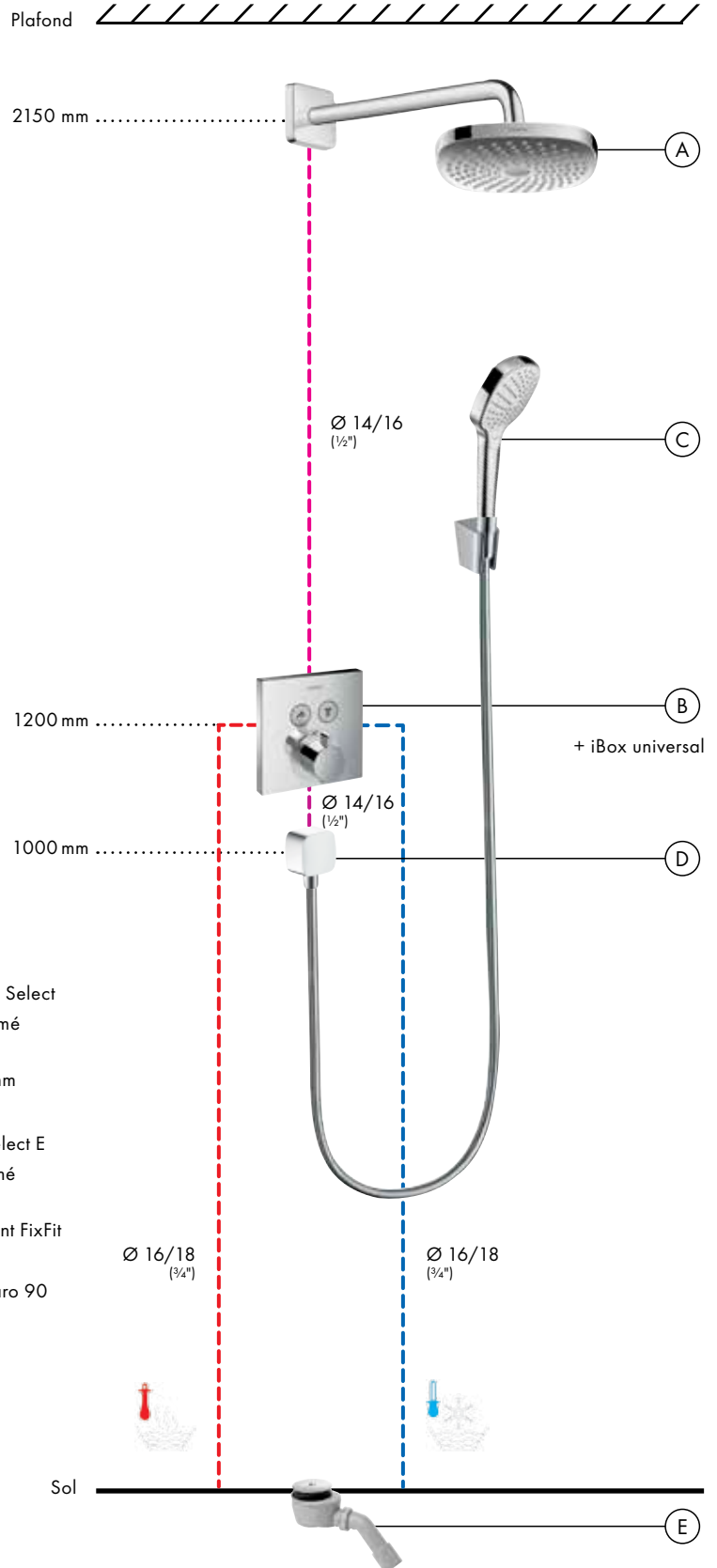

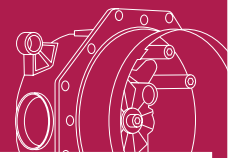

iBox® universal

Variante de pose pour
2 fonctions

Pose pour 2 fonctions

Diagramme de débit

Douche de tête Raindance E 240 Air
27370000

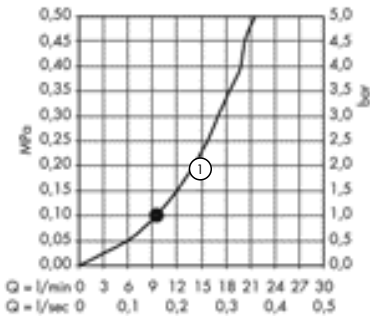

Legende

- ① RainAir

Diagramme de débit

Douchette à main Raindance E 120 3jet
26520000

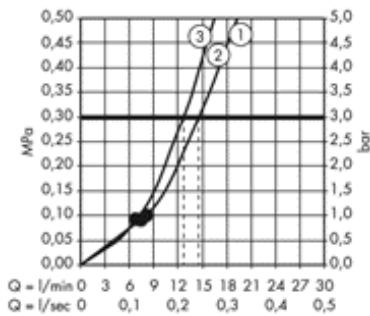

Legende

- ① RainAir
- ② Rain
- ③ Whirl

A partir de • le fonctionnement est garanti

Composants

Robinetteries

- ⑤ iBox universal
01800180
ShowerSelect Thermostatique
15763000



Alternative:
Thermostatique E avec
robinet d'arrêt intégré
31573000

TOTAL : 1.408 €

Autres alternatives possibles.

Douches

- ④ Douche de tête
Raindance E 240 Air
27370000
- ③ Douchette à main
Raindance Select E 120
26520000
- Support de douche Porter S
28331000
- Flexible de douche Isiflex
28276000
- ⑥ Coude de raccordement FixFit
27453000
- ⑦ Système de vidage Staro 90
60056000

TOTAL : 1.450 €

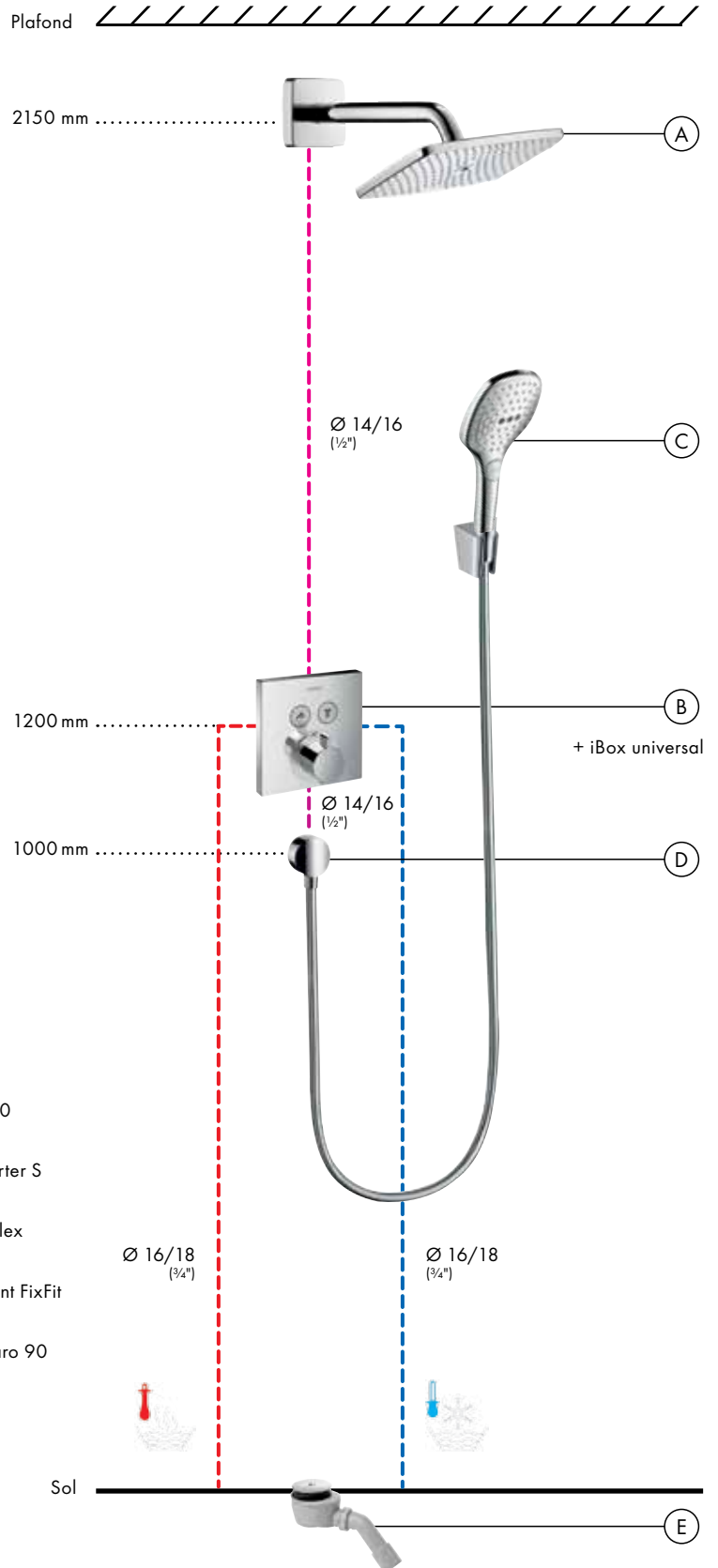

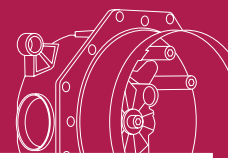

iBox® universal

Variantes de pose pour
2 fonctions

Pose pour 2 fonctions : Select

Diagramme de débit

Douche de tête Raindance Select S 300 2jet
27378000

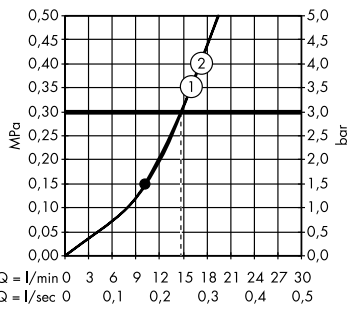

Légende

- ① Rain
- ② RainAir

Diagramme de débit

Douchette à main Raindance S 120 3jet
26530000

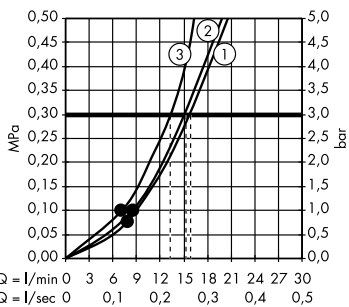

Légende

- ① Rain
- ② Rain
- ③ Whirl

A partir de • le fonctionnement est garanti

Composants

Robinetteries

- ② iBox universal
01800180
ShowerSelect Thermostatique
15743000



Alternative:
Thermostatique E avec
robinet d'arrêt intégré
15758000

TOTAL : 1.330 €

Autres alternatives possibles.

Douches

- ① Raindance Select S 300 2jet
Douche de tête
27378000
- ③ Set Porter'S/Raindance Select
S 120
26721000
- ④ Coude de raccordement FixFit
27453000
- ⑤ Système de vidage Staro 90
60056000

TOTAL : 1.490 €

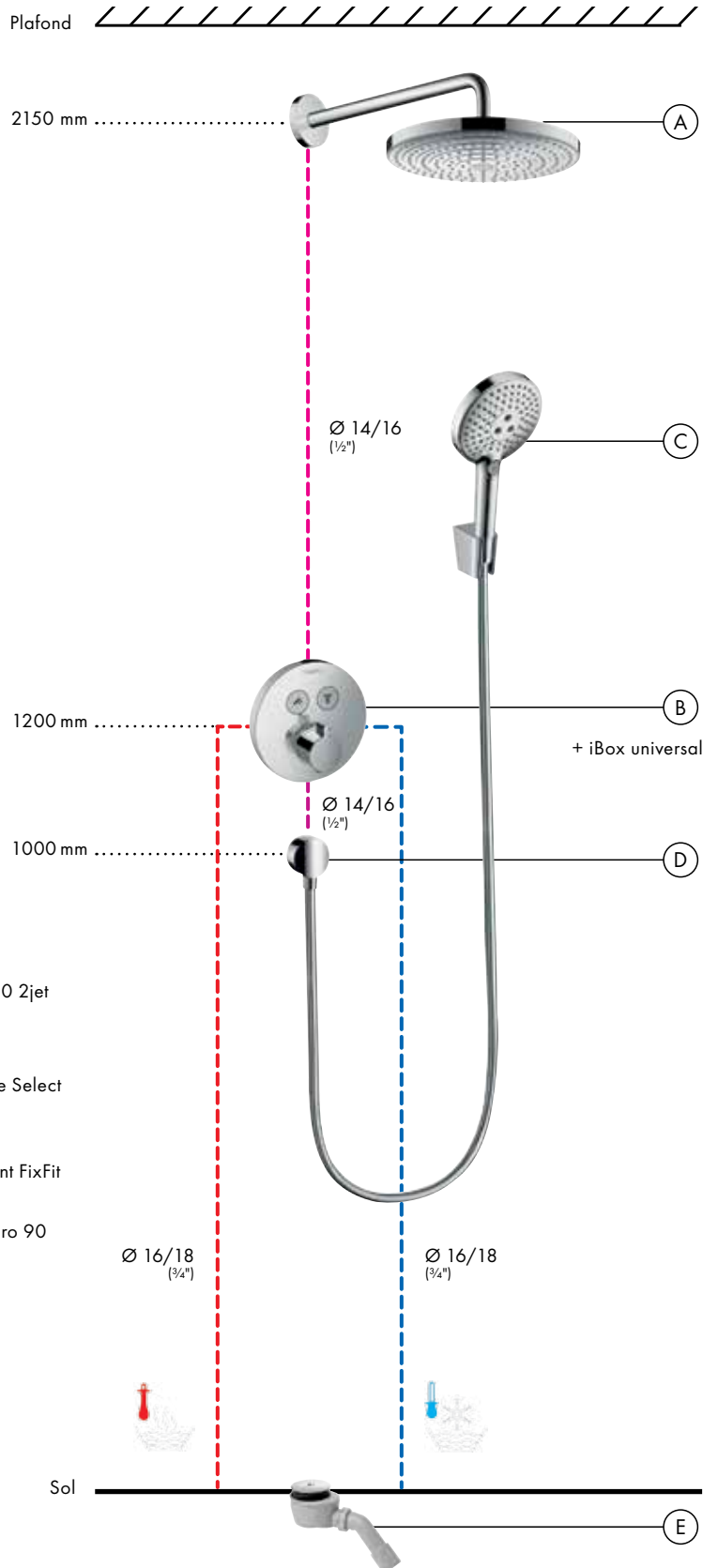

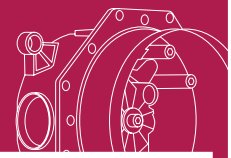

iBox® universal
Variantes de pose pour
2 fonctions

Pose pour 2 fonctions : Select

Diagramme de débit

Douche de tête Raindance Select E 300 2jet
27385000

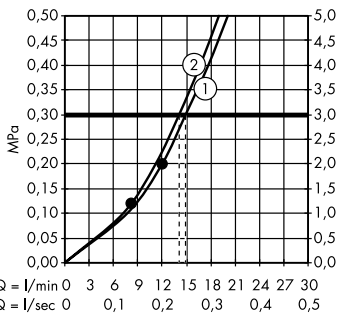

Légende

- ① Rain
- ② RainAir

Diagramme de débit

Douchette à main Raindance Select E 120 3jet
26520000

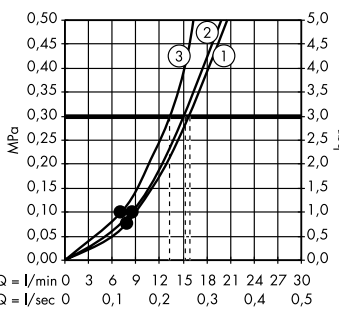

Légende

- ① RainAir
- ② Rain
- ③ Whirl

A partir de • le fonctionnement est garanti

Composants

Robinetteries

- ③ iBox universal
01800180 **105 € HT**
- ShowerSelect Thermostatique
15765000 **715 € HT**

Douches

- ① Douche de tête Raindance Select
E 300 2jet
27385000 **570 € HT**
- ② Douchette Raindance Select E
120 3jet
26520000 **92 € HT**
- ④ Flexible Isiflex 1,60 m
28276000 **28 € HT**

TOTAL : 1.510 €

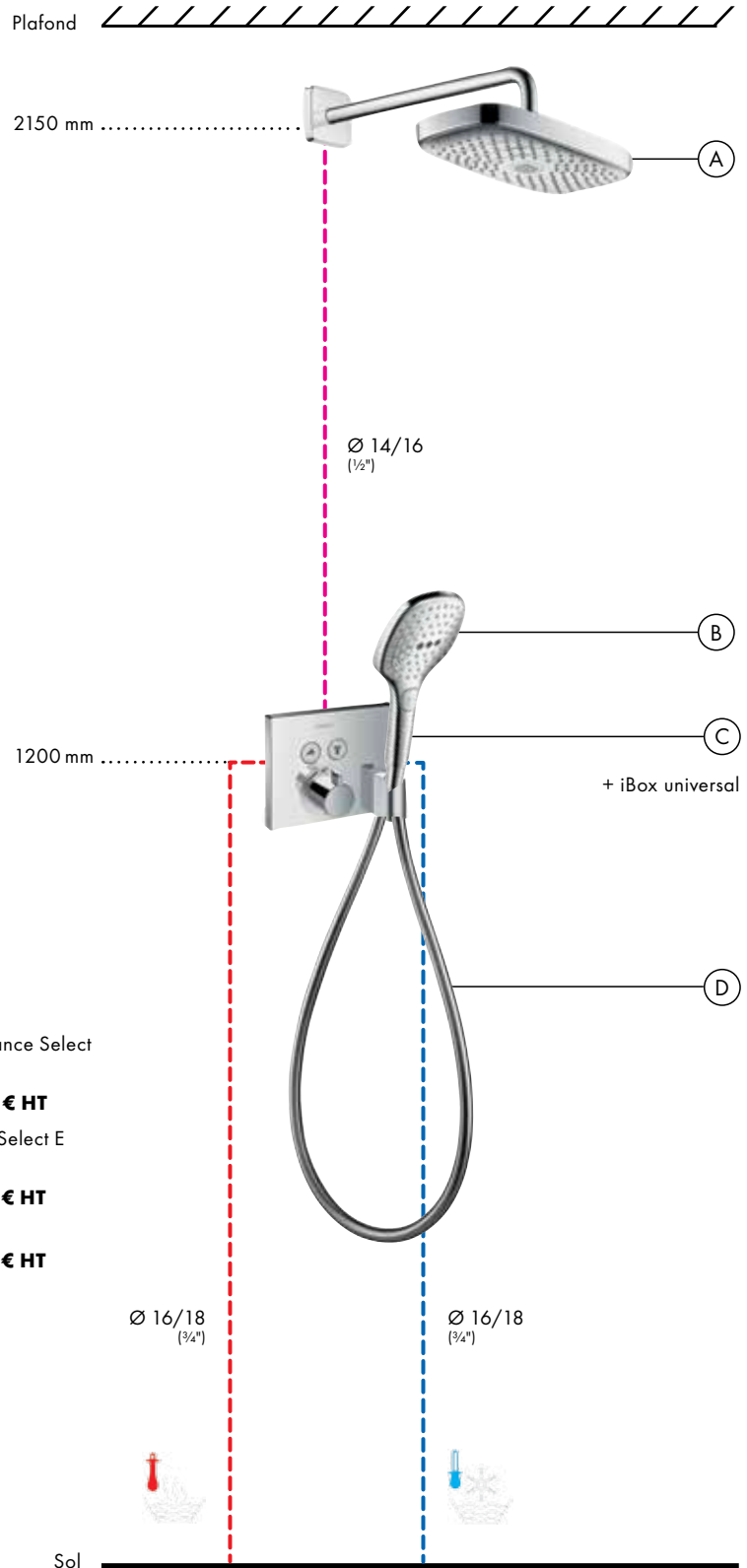

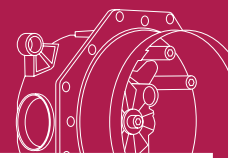

iBox® universal
Variantes de pose pour
2 fonctions

Pose pour 2 fonctions : ShowerSelect

Diagramme de débit

Douche de tête Rainmaker Select 460 1jet
24003400

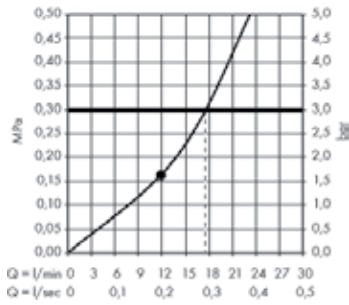

Légende
■ Rain

Diagramme de débit

Douchette à main Raindance E 120 3jet
26520000

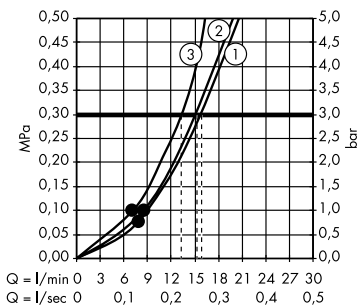

Légende
① ■ RainAir
② ■ Rain
③ ■ Whirl

A partir de • le fonctionnement est garanti

Composants

Robinetteries

ⓑ ShowerTablet
13184400

Douches

Ⓐ Rainmaker Select 460 1jet
Douche de tête
24003400

ⓒ Set Porter'S/Raindance Select
E 120
26720400

Ⓓ Système de vidage Staro 90
60056000

TOTAL : 2.836 €

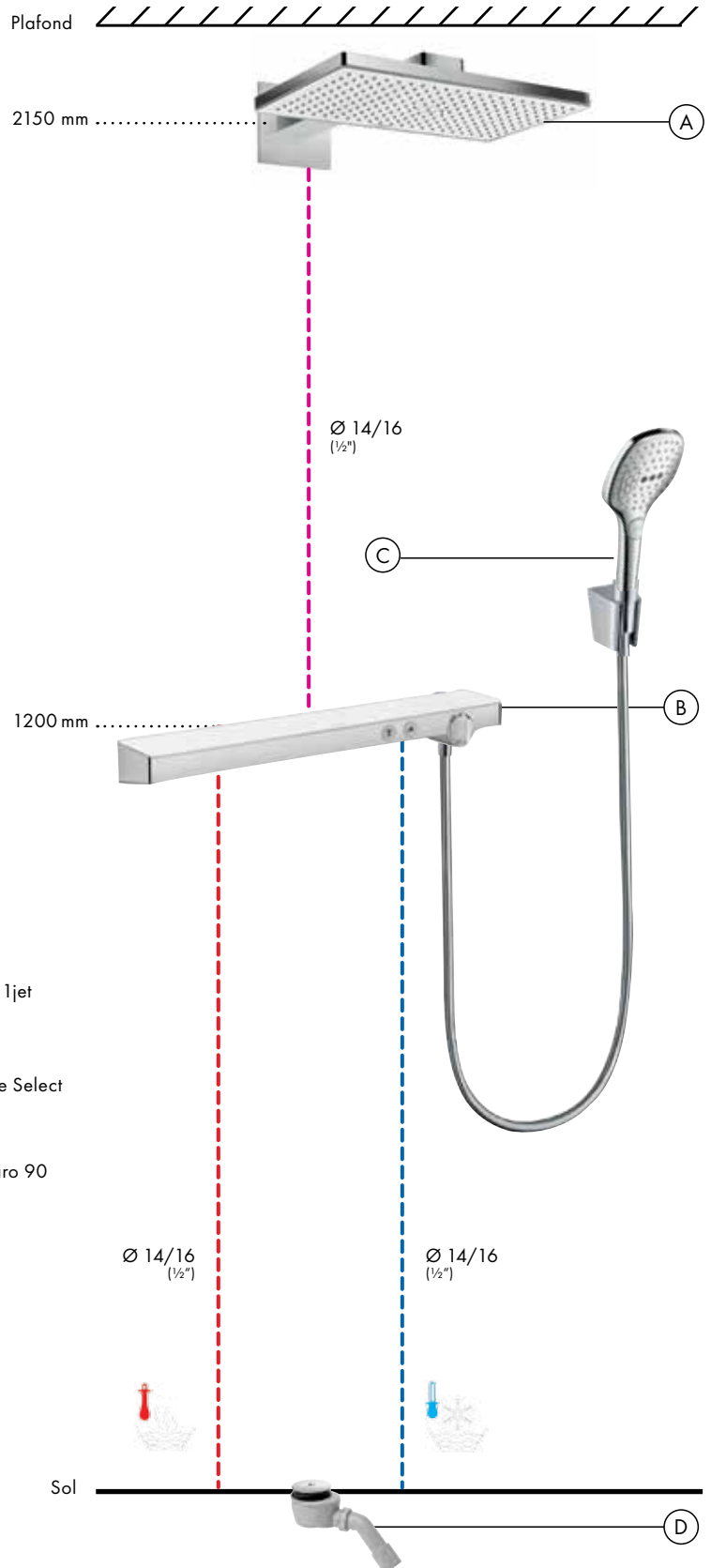

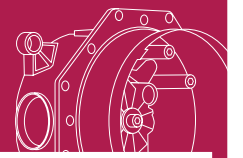

iBox® universal

Variante de pose pour
3 fonctions

Pose pour 3 fonctions : Select

Diagramme de débit

Douche de tête Raindance E 420 2jet
27373000

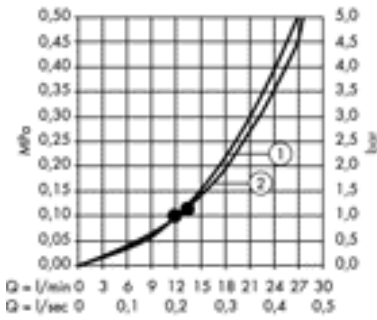

Legende

- ① RainAir
- ② Rainflow

Diagramme de débit

Douchette à main Raindance E 150 3jet
26550000

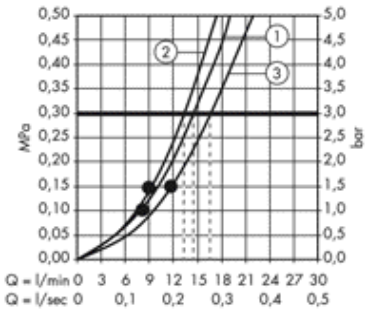

Legende

- ① RainAir
- ② CaresseAir
- ③ Mix

A partir de • le fonctionnement est garanti

Composants

Montage des robinetteries

- Ⓒ iBox universal
01800180
Robinet pour
3 fonctions
15764000
- Ⓓ iBox universal
01800180
ShowerSelect Thermostatique
15760000

Douche

- Ⓐ Douche de tête
Raindance E 420 2jet
27373000
iBox universal
01800180
- Ⓑ Douchette à main
Raindance Select E 150
26550000
Support de douche Porter S
28331000
Flexible de douche Isiflex
28276000
- Ⓔ Coude de raccordement FixFit
27453000
- Ⓕ Système de vidage Raindrain
XXL # 60067000

- Alternative:
iControl
15777000
- Thermostatique E
haut débit
15706000

TOTAL : 2.563 €

Autres alternatives possibles.

TOTAL : 2.578 €

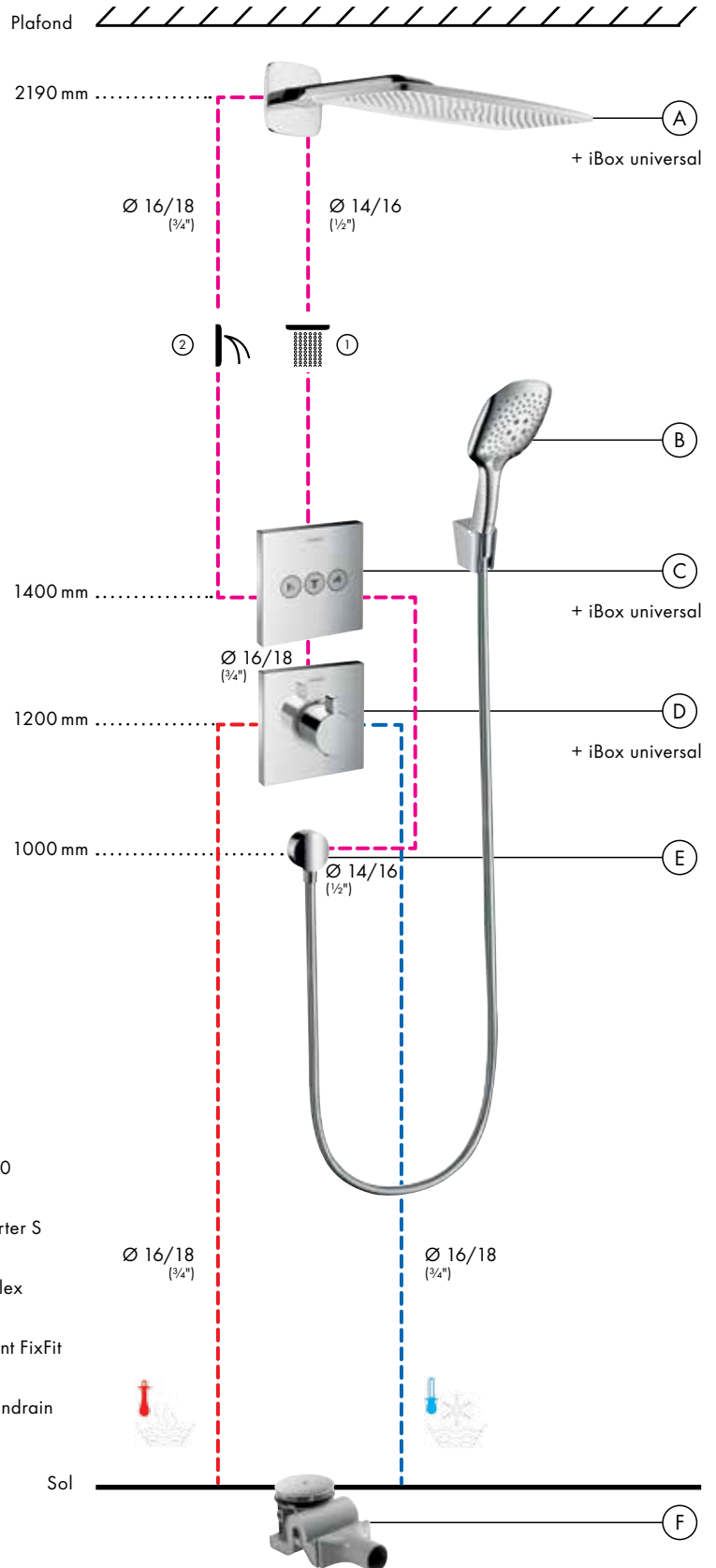

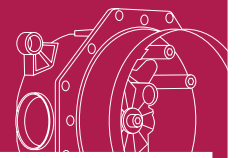

iBox® universal

Variante de pose pour
3 fonctions

Pose pour 3 fonctions : Select

Diagramme de débit

Douche de tête Raindance Rainfall 2jet
28433000

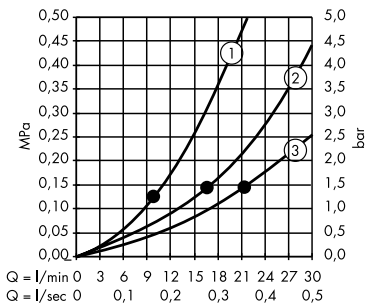

Legende

- ① RainAir
- ② Rainflow
- ③ RainAir + Rainflow

Diagramme de débit

Douchette à main Raindance E 120 3jet
26520000

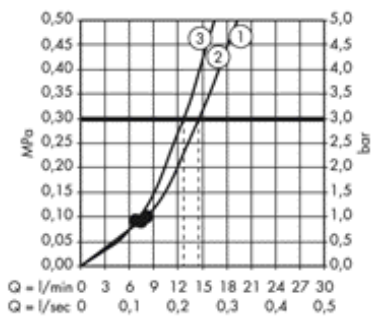

Legende

- ① RainAir
- ② Rain
- ③ Whirl

A partir de • le fonctionnement est garanti

Composants

Montage des robinetteries

- Ⓒ iBox universal
01800180
Robinet pour
3 fonctions
15764000
- Ⓓ iBox universal
01800180
ShowerSelect Thermostatique
15760000

Douche

- Ⓐ Douche de tête
Raindance Rainfall 2jet
28433000
iBox universal
01800180
- Ⓑ Set Porter'S/Raindance Select E
120 3jet
26720000
- Ⓔ Coude de raccordement FixFit
27453000
- Ⓕ Système de vidage Raindrain
XXL # 60067000

TOTAL : 2.704 €



Alternative:
iControl
31958000



Thermostatique E
haut débit
31571000

TOTAL : 2.764 €

Autres alternatives possibles.

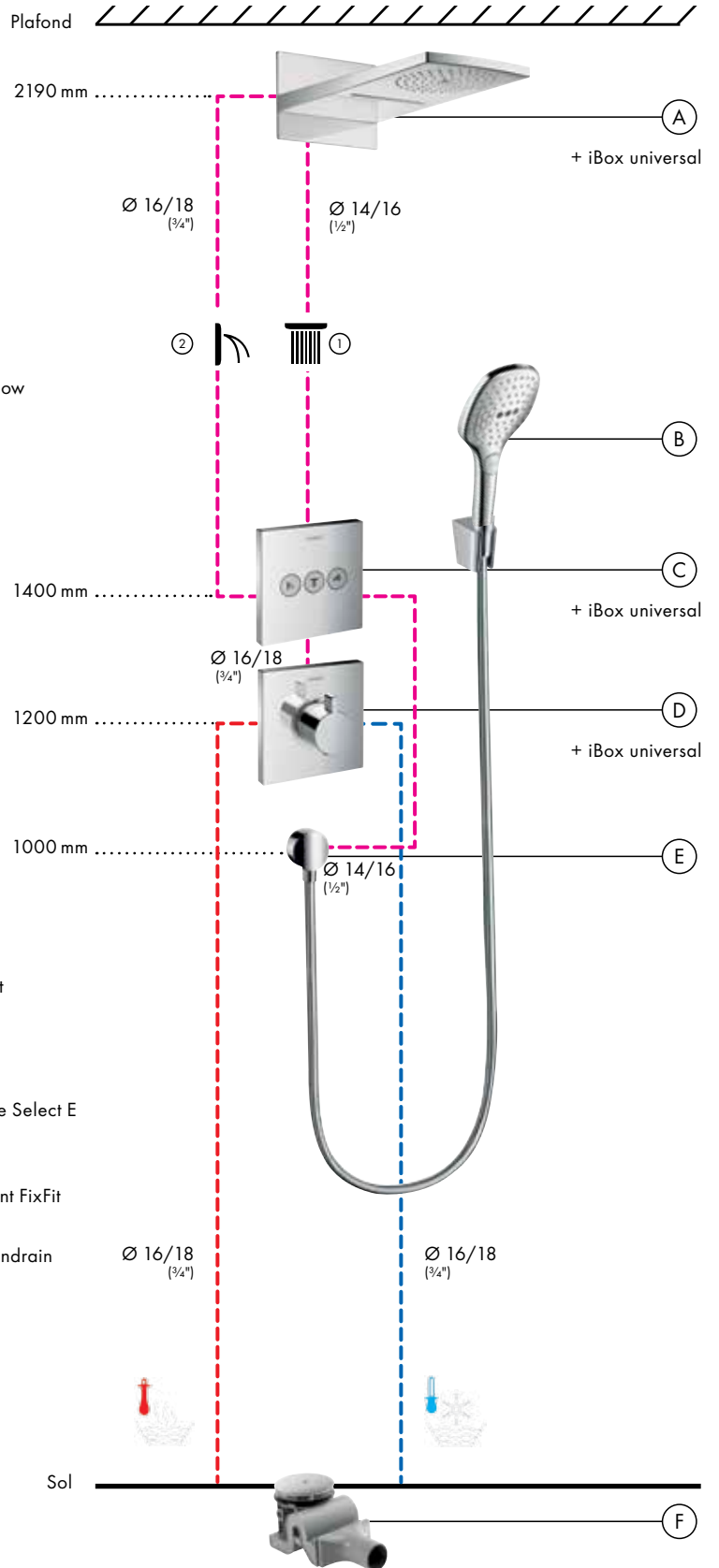

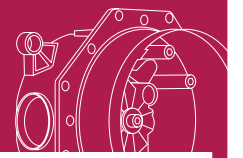

iBox® universal

Variantes de pose pour
3 fonctions

Pose pour 3 fonctions : Select

Diagramme de débit

Douche de tête Raindance Air 1jet 260 x 260 mm
26472000

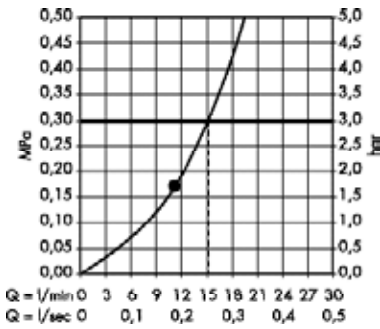

Legende

① RainAir

Diagramme de débit

Douchette à main Raindance E 120 3jet
26520000

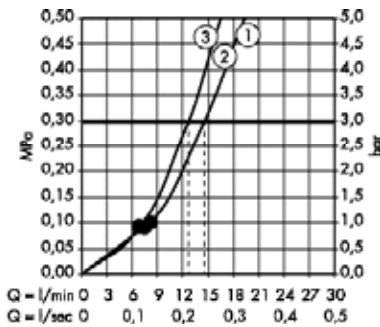

Legende

① RainAir
② Rain
③ Whirl

A partir de • le fonctionnement est garanti

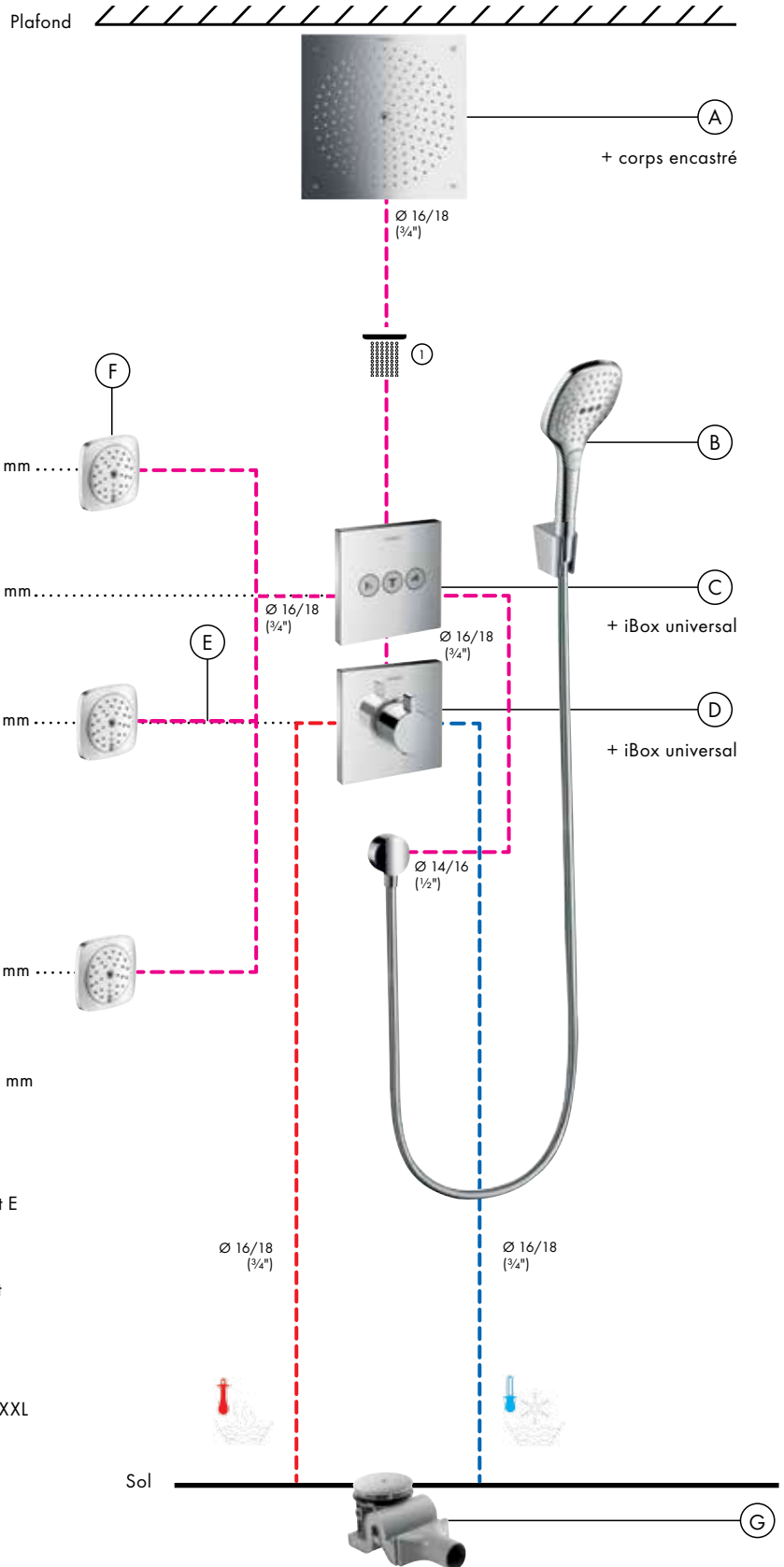

Composants

Montage des robinetteries

- Ⓒ iBox universal
01800180
- Robinet pour
3 fonctions
15764000
- Ⓓ iBox universal
01800180
- ShowerSelect Thermostatique
15760000

Installation de la douche

- Ⓐ Douche de tête
Raindance Air 1jet 260 x 260 mm
26472000
- Corps encastré
26471180
- Ⓑ Set Porter'S/Raindance Select E
120 3jet
26720000
- Ⓔ Coude de raccordement FixFit
26455000
- Ⓕ Douche latérale x 3
28430000
- Ⓖ Système de vidage Raindrain XXL
60067000

TOTAL : 2.212 €



Alternative:
iControl
31958000



Thermostatique E
haut débit
31571000

TOTAL : 2.272 €

Autres alternatives possibles.

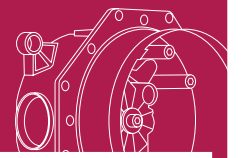

iBox® universal

Variante de pose pour
4 fonctions

Pose pour 4 fonctions : Select

Diagramme de débit

Douche de tête Raindance Rainfall 3jet
#28411000

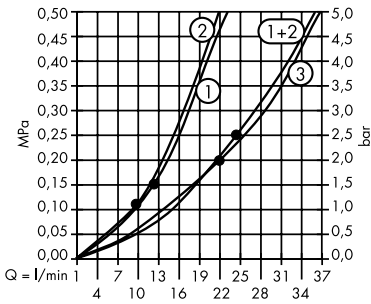

Legend

- ① RainAir
- ② Whirl
- ③ Rainflow

Diagramme de débit

Douchette à main Raindance E 120 3jet
#26520000

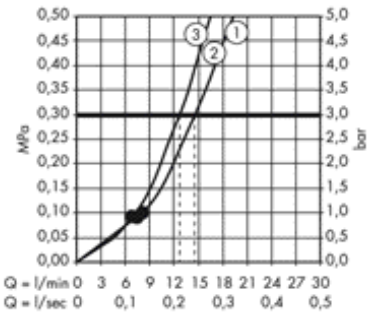

Legend

- ① RainAir
- ② Rain
- ③ Whirl

A partir de • le fonctionnement est garanti

Composants

Montage des robinetteries

- Ⓒ iBox universal
#01800180
Robinet pour
3 fonctions
#15764000
- Ⓓ iBox universal
#01800180
ShowerSelect Thermostatique
#15761000

Installation de la douche

- Ⓐ Douche de tête
Raindance Rainfall 3jet
#28411000
iBox universal
#01800180
- Ⓑ Set Porter'S/Raindance Select
E 120 3jet
#26720000
- Ⓔ Coude de raccordement FixFit
#27453000
- Ⓕ Système de vidage Raindrain
XXL #60067000

TOTAL : 4.154 €

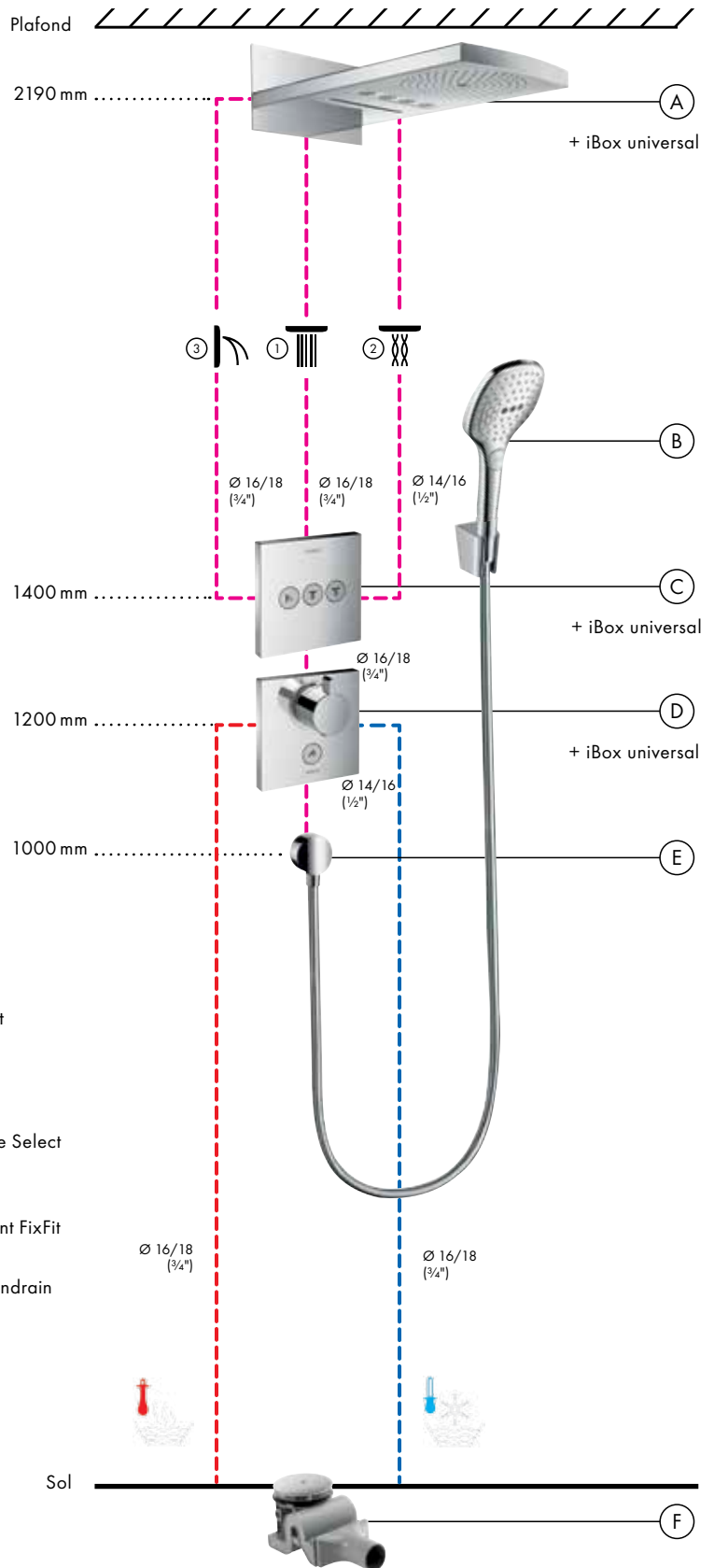

Les solutions pour le bain



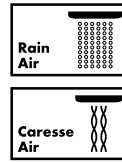

PuraVida 150 Air 3jet

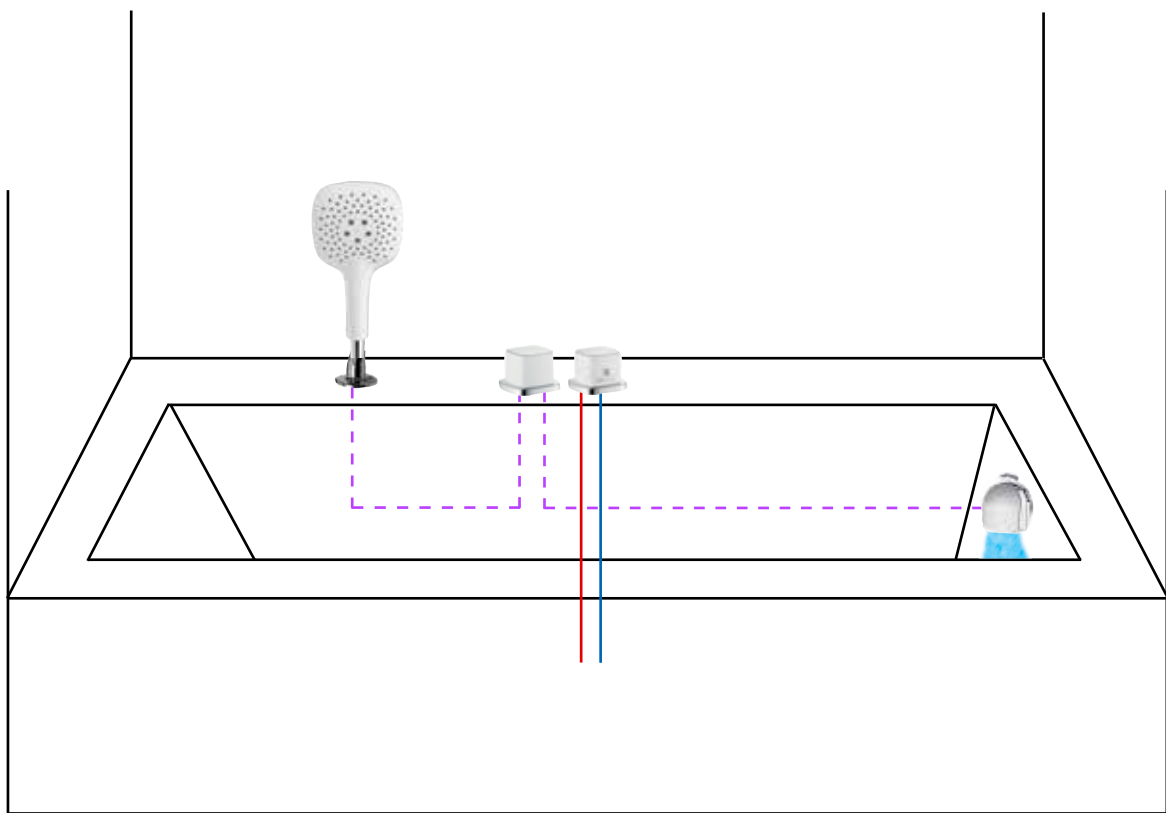

Corps encastré

2 trous
thermostatique PuraVida

CHIFFRAGE SOLUTION PuraVida

Douchette PuraVida 150 Air 3jet
Thermostatique 2 trous PuraVida - Blanc/chromé

15474400	Batterie thermostatique 2 trous	370,00
13550180	Corps enc. thermostatique	769,00
96387000	Flexible de raccordement	55,00
58123000	Exafill E	265,00
58191000	Gaine de raccordement	108,00
28307000	Support douchette encastré	108,00
28557400	Douchette PuraVida 150 Air 3jet	160,00
TOTAL HT		1.836,00

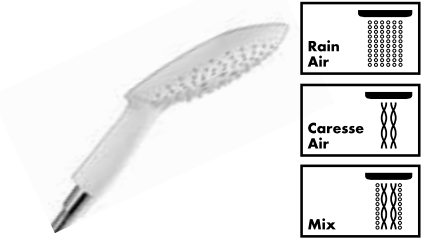
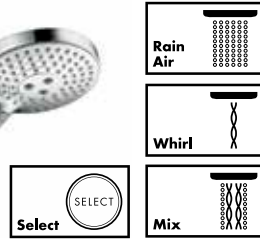
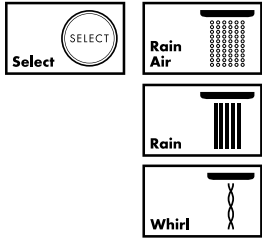

**Raindance
Select E 120 Air 3jet**

**Raindance Select
S 120 Air 3jet**

**PuraVida
150 Air 3jet**

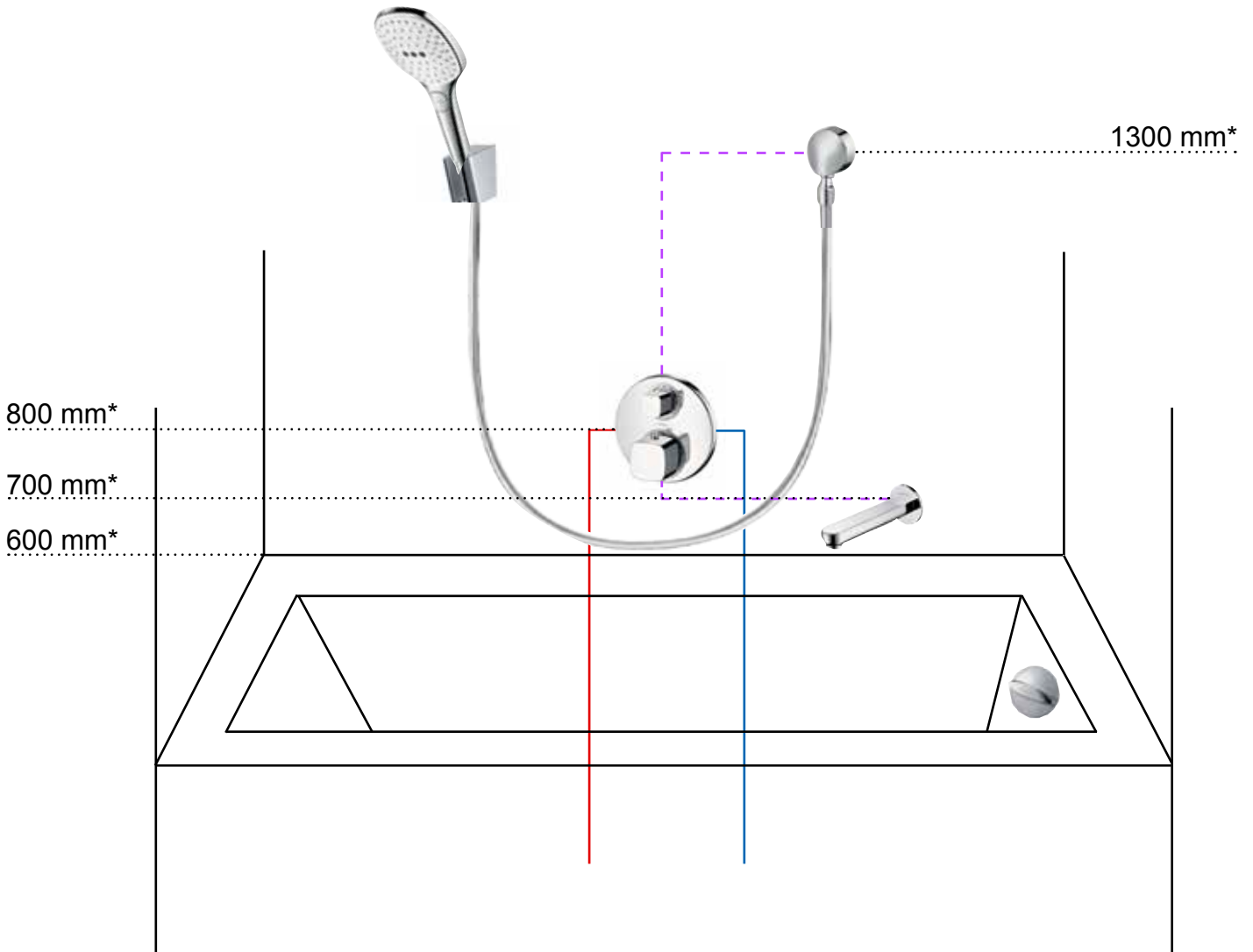

**Thermostatique
avec robinet d'arrêt
et inverseur E**



**Thermostatique
avec robinet d'arrêt
et inverseur S**



**Thermostatique
avec robinet d'arrêt
et inverseur PuraVida**

CHIFFRAGE DES SOLUTIONS Ecostat E - Ecostat S - PuraVida

Douchette Raindance Select E 120 Air 3jet Thermostatique avec rob. arrêt et inverseur E - Chromé

01800180	iBox	105,00
31573000	Thermostatique avec RA + inverseur E	553,00
14420000	Bec déverseur	155,00
27505000	Fixfit	30,00
28276000	Isiflex 1,60 m	28,00
28331000	Porter'S	25,00
26520000	Douchette Raindance Select E 120 3jet	92,00
58150000	Vidage Flexaplus E pour baignoire standard	83,00
TOTAL HT		1.071,00

Douchette Raindance Select S 120 Air 3jet Thermostatique avec rob. arrêt et inverseur S - Chromé

01800180	iBox	105,00
15721000	Thermostatique avec RA + inverseur S	673,00
14420000	Bec déverseur	155,00
27505000	Fixfit	30,00
28276000	Isiflex 1,60 m	28,00
28331000	Porter'S	25,00
26530000	Douchette Raindance Select S 120 3jet	92,00
58142000	Vidage Flexaplus S pour baignoire standard	73,00
TOTAL HT		1.181,00

Douchette PuraVida 150 Air 3jet Thermostatique avec rob. arrêt et inverseur PuraVida - Blanc/chromé

01800180	iBox	105,00
15771400	Thermostatique avec RA + inverseur PuraVida	1.092,00
15412400	Bec déverseur	292,00
27414000	Fixfit	44,00
28276000	Isiflex 1,60 m	28,00
28331000	Porter'S	25,00
28557400	Douchette PuraVida 150 Air 3jet	160,00
58150000	Vidage Flexaplus E pour baignoire standard	83,00
TOTAL HT		1.832,00

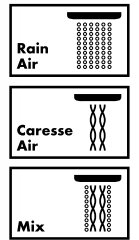

Set Raindance Select E 120
Air 3jet Unica'S Puro 65 cm

Set Raindance Select S 120
Air 3jet Unica'S Puro 65 cm

Set de douche PuraVida 150
Air 3jet Unica 90 cm

2250 mm*

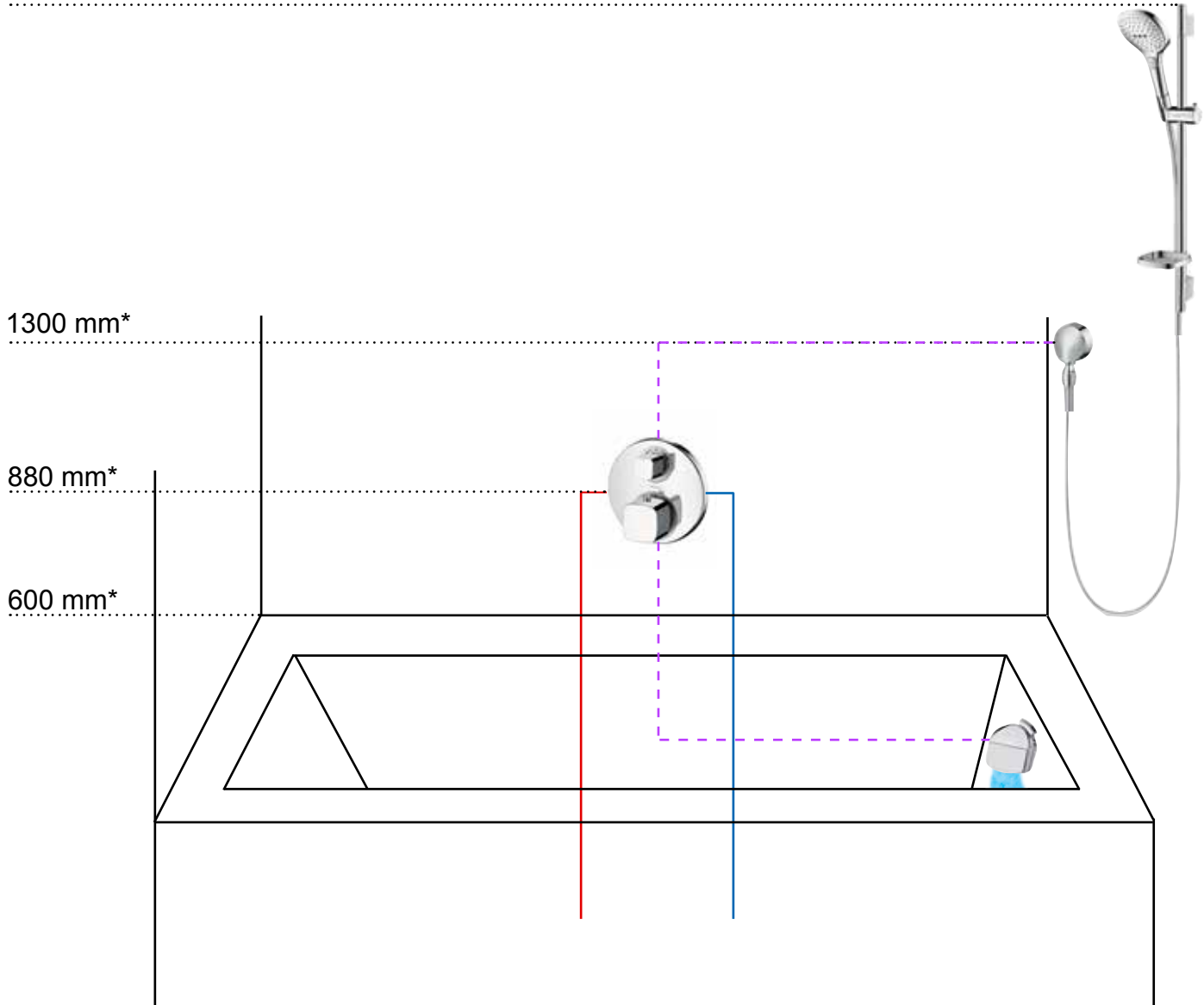

Thermostatique
avec robinet d'arrêt
et inverseur E

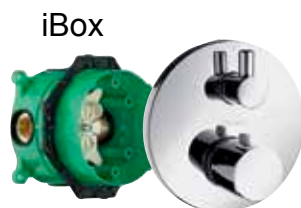

Thermostatique
avec robinet d'arrêt
et inverseur S



Thermostatique
avec robinet d'arrêt
et inverseur PuraVida

CHIFFRAGE DES SOLUTIONS Ecostat E - Ecostat S - PuraVida

Set de douche Raindance Select E 120 Air 3jet / Unica'S Puro 65 cm Thermostatique avec rob. arrêt et inverseur E - Chromé

01800180	iBox	105,00
31573000	Thermostatique avec RA et inverseur E	553,00
58123000	Exafill E	265,00
27505000	Fixfit E	30,00
26620000	Set Raindance Select E 120 Air 3jet	189,00
TOTAL HT		1.142,00

Set de douche Raindance Select S 120 Air 3jet / Unica'S Puro 65 cm Thermostatique avec rob. arrêt et inverseur S - Chromé

01800180	iBox	105,00
15721000	Thermostatique avec RA et inverseur S	673,00
58113000	Exafill S	265,00
27506000	Fixfit S	34,00
26630000	Set Raindance Select S 120 Air 3jet	189,00
TOTAL HT		1.266,00

Set de douche PuraVida 90 cm Thermostatique avec rob. arrêt et inverseur PuraVida - Blanc/chromé

01800180	iBox	105,00
15771400	Thermostatique avec RA et inverseur PuraVida	1.095,00
58123000	Exafill E	265,00
27414000	Fixfit PuraVida	44,00
27853400	Set de douche PuraVida 90 cm	399,00
TOTAL HT		1.908,00

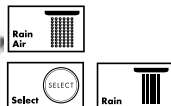

Douche de tête Raindance E 300 2jet
Raindance Select E 120 Air 3jet

Douche de tête Raindance S 300 2jet
Raindance Select S 120 Air 3jet

Douche de tête PuraVida 400
Douchette 150 Air 3jet

2250 mm*

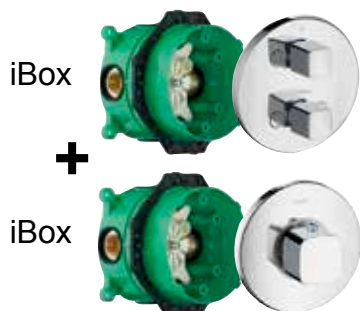
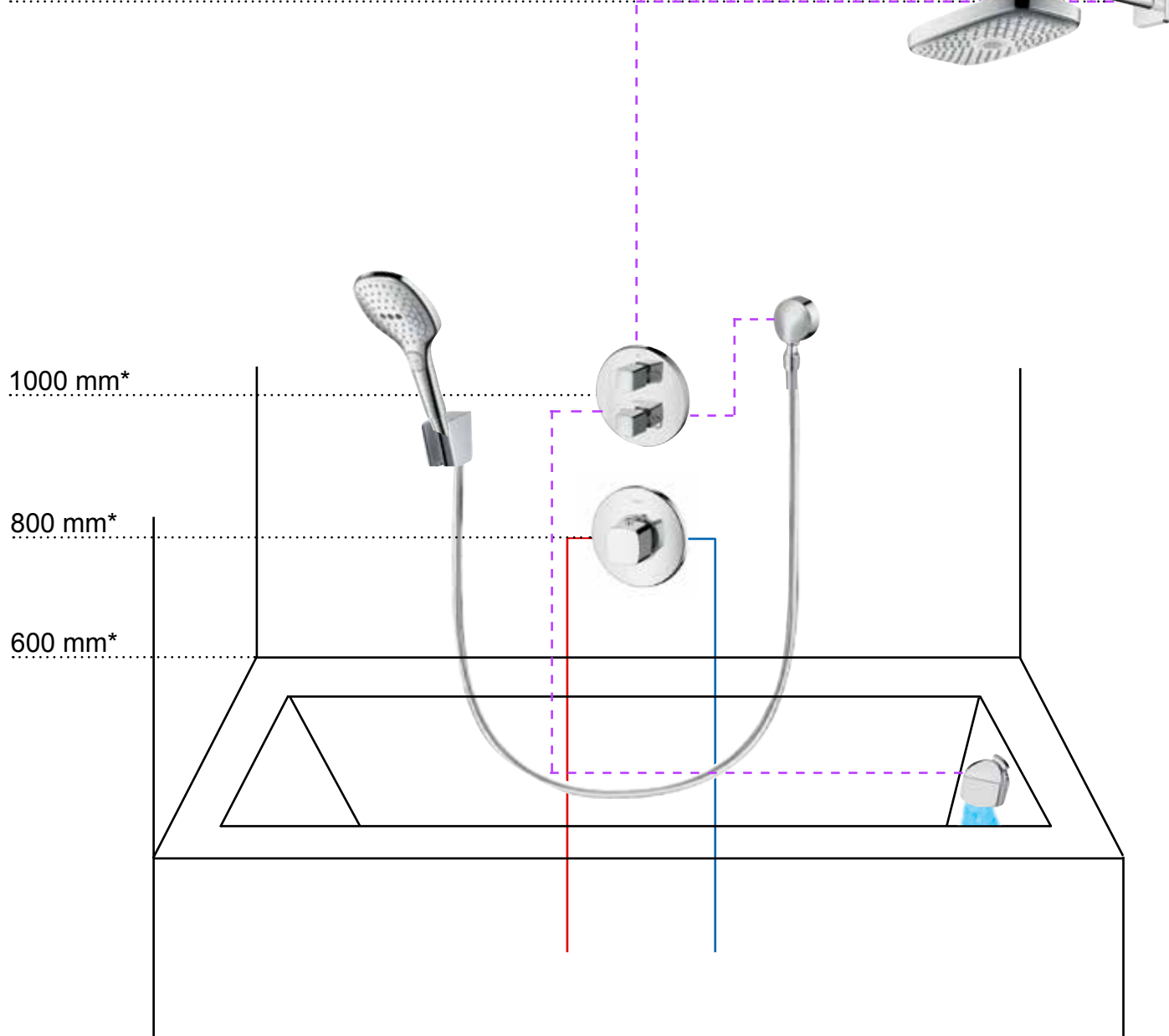

iControl
+
Thermostatique E

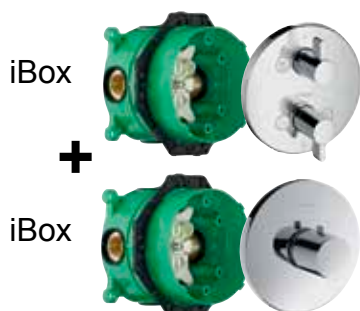

iControl
+
Thermostatique S

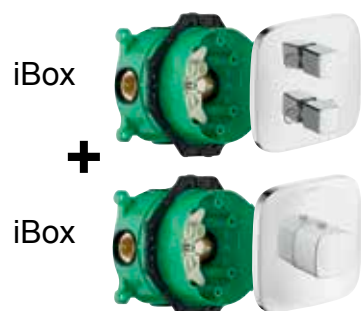

iControl
+
Thermostatique PuraVida

CHIFFRAGE DES SOLUTIONS Ecostat E - Ecostat S - PuraVida

Douchette Raindance Select E 120 Air 3jet Thermostatique avec rob. arrêt et inverseur E - Chromé

01800180 x 2	iBox	210,00
31958000	iControl E	358,00
31570000	Thermostatique E	311,00
58123000	Exafill E	265,00
27385000	Douche de tête Raindance Select E 300 2jet	570,00
27505000	Fixfit E	29,00
28276000	Isiflex 1,60 m	28,00
28331000	Porter'S	25,00
26520000	Douchette Randaince Select E 120 3jet	92,00
TOTAL HT		1.889,00

Douchette Raindance Select S 120 Air 3jet Thermostatique avec rob. arrêt et inverseur S - Chromé

01800180 x 2	iBox	210,00
15955000	iControl S	415,00
15711000	Thermostatique S	482,00
58113000	Exafill S	265,00
27378000	Douche de tête Raindance Select S 300 2jet	560,00
27506000	Fixfit S	34,00
28276000	Isiflex 1,60 m	28,00
28331000	Porter'S	25,00
26530000	Douchette Randaince Select S 120 3jet	92,00
TOTAL HT		2.111,00

Douchette PuraVida 150 Air 3jet - Blanc/chromé Thermostatique avec rob. arrêt et inverseur PuraVida

01800180 x 2	iBox	210,00
15777400	iControl PuraVida	410,00
15772400	Thermostatique PuraVida	840,00
58123000	Exafill E	265,00
27437400	Douche de tête PuraVida 400	1.195,00
27414000	Fixfit PuraVida	44,00
28276000	Isiflex 1,60 m	28,00
28331000	Porter'S	25,00
28557400	Douchette PuraVida 150 Air 3jet	160,00
TOTAL HT		3.177,00



⑦ Axor Massaud + corps encastré

Corps encastré 10452180

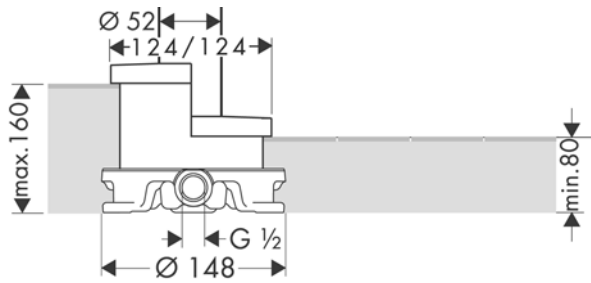

Corps encastré 16549180

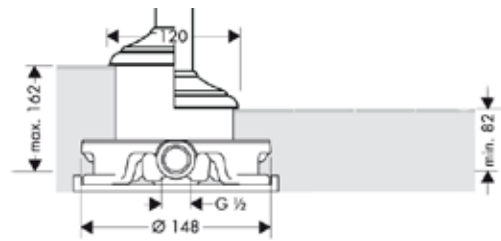

① Axor Starck + corps encastré



② Axor Citterio E + corps encastré



③ PuraVida + corps encastré



④ Axor Citterio + corps encastré



⑤ Axor Urquiola + corps encastré



⑥ Axor Montreux + corps encastré

CHIFFRAGE DES SOLUTIONS

PuraVida - Axor Citterio E - Axor Starck - Axor Citterio Axor Urquiola - Axor Montreux - Axor Massaud

① Axor Starck - Chromé

10456000	Mitigeur B/D sur pied	1.490,00
10452180	Corps encastré	455,00
TOTAL HT		1.945,00

② Axor Citterio E - Chromé

36416000	Mitigeur B/D sur pied	1.835,00
10452180	Corps encastré	455,00
TOTAL HT		2.290,00

③ PuraVida - Blanc/chromé

15473400	Mitigeur B/D sur pied	2.187,00
10452180	Corps encastré	455,00
TOTAL HT		2.642,00

④ Axor Citterio - Chromé

39451000	Mitigeur B/D sur pied	2.175,00
10452180	Corps encastré	455,00
TOTAL HT		2.630,00

⑤ Axor Urquiola - Chromé

11422000	Mitigeur B/D sur pied	2.400,00
10452180	Corps encastré	455,00
TOTAL HT		2.855,00

⑥ Axor Montreux - Chromé

16547000	Mélangeur B/D sur pied	2.359,00
16549180	Corps encastré	812,00
TOTAL HT		3.171,00

⑦ Axor Massaud - Chromé

18450000	Mitigeur B/D sur pied	3.100,00
10452180	Corps encastré	455,00
TOTAL HT		3.555,00

Options :

Rosace d'étanchéité réf. 96441000

112,50 €

Rallonge 60mm pour chape trop épaisse réf. 97686000

237,00 €

A votre service

Site Hansgrohe Axor
Site Pièces détachées

www.pro.hansgrohe.fr
<http://spares.hansgrohe.com>

Service Technique

3 lignes :
01 46 11 45 36 - 01 46 11 45 37 - 01 46 11 45 38
servicetechnique@hansgrohe.fr

Service Commande

Fax : 01 46 11 45 19
orders@hansgrohe.fr

Service Client

Tél : 01 46 11 45 00 Fax : 01 46 11 45 39
contact-fr@hansgrohe.com

**Nous faisons de vos
exigences notre
référence.**

Qualité signée Hansgrohe.



**Das Original.
Depuis 1901**

Pour tout savoir sur le thème de l'eau et Hansgrohe, rendez-vous sur [facebook.com/hansgrohe](https://www.facebook.com/hansgrohe) twitter.com/hansgrohe_pr



www.facebook.com/hansgrohe



www.twitter.com/hansgrohe_pr



www.youtube.com/hansgrohe