



**Sales manual**

Hansgrohe bathroom and kitchen range

**The complete guide to  
Hansgrohe mixers, showers  
and installation systems**



**UNIDOMO®**

**Web:** [www.unidomo.de](http://www.unidomo.de)

**Telefon:** 04621- 30 60 89 0

**Mail:** [info@unidomo.com](mailto:info@unidomo.com)

**Öffnungszeiten:** Mo.-Fr. 8:00-17:00 Uhr

**VIESMANN**

**Buderus**

 **Vaillant**

**WOLF**

 **JUNKERS**  **BOSCH**

 **remeha**

 **DAIKIN**

**ROTEX**

a member of DAIKIN group



-  Individuelle Beratung
-  Kostenloser Versand
-  Hochwertige Produkte

-  Komplettpakete
-  Über 15 Jahre Erfahrung
-  Markenhersteller

# New product innovations create delight



Consumers don't just want first-class products; they also want help and advice. As your partner, we at Hansgrohe make every effort to ensure you have all the information and support you need to secure that all important sale. We offer you

innovative products and everything you need for successful consultations with your customers.

The trend is for increasingly large showers and luxurious, stylish bathrooms. Thanks to the new glass surfaces, the Rainmaker Select range integrates beautifully in the room, and the overhead shower becomes an integral design element with iconic appeal.

Another revolution awaits your customers at the basin: thanks to the new Talis Select mixers, Select technology is now also available there with intuitive operation at the touch of a button. This completes the Select range for the bathroom – or even for the complete Select household. This intuitive operating system is now available on hand and overhead showers, the shower control,

and on basin and kitchen mixers. You also have a large number of other innovations, such as the Crometta Select showers, the Crometta 100 shower line and the new Logis mixer lines, all at entry-level prices, giving you lots of new ways to delight your customers. We have also optimised this sales manual, to include a more detailed range overview to make our product offering and each product's benefits as clear and easy to follow as we can. So leading your customer through our huge range of options is as easy as 1. 2. 3. We wish you every success – and thrilled customers every day.

Yours, Richard Grohe

## Be sure to use the Hansgrohe showroom app to illustrate and advise – your appealing and interactive sales aid:

- Camera function that can be used to place every product in your own bathroom
- Videos to illustrate our unique technology
- Configurator for matching basin mixer combinations
- Favorites wish list for printing out
- Search function for finding products quickly

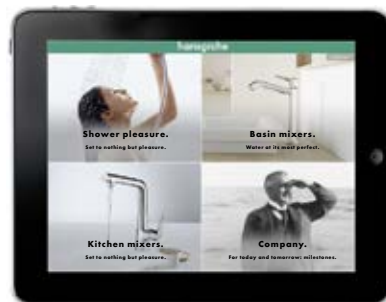

Download now for free at [www.hansgrohe-int.com/catalog](http://www.hansgrohe-int.com/catalog)  
or directly from iTunes at  
<http://appstore.com/hansgroheshowroom>

# Contents

---

**6** Hansgrohe quality

**8** Hansgrohe Select

---

## **14 Showers and shower control**

**16** Spray modes

**18** Shower technologies

**20** Large showers with Rainmaker® Select

**28** Installation examples of Rainmaker® Select

**38** Hand showers and shower sets

**56** Overhead and side showers

**70** Showerpipes

**86** Showerpanel®

**88** Exposed thermostats

**98** Concealed finish sets/Concealed thermostats/Concealed valves

**111** Concealed installation iBox® universal

**116** Shower control RainBrain®

**118** Installation examples of ShowerSelect®

---

## **124 Bath mixers**

**126** ComfortZone

**128** ComfortZone test

**130** Mixer technologies

**134** Bathroom mixers - overview

**140** PuraVida®

**146** Metris®

**152** Talis® Select S/Talis® S/Talis®

**158** Talis® Select E/Talis® E

**162** Focus®

**164** Logis®

**168** Metris® Classic

**170** Talis® Classic

**172** Logis® Classic

**174** Care mixers

**176** Electronic basin mixer

**178** Accessories Logis®/Accessories Logis® Classic

**180** Waste systems

---

## **184 Kitchen mixers**

**186** Kitchen mixers - overview

**188** PuraVida®

**190** Metris® Select/Metris®

**192** Talis® Select/Talis®/Talis® Classic

**194** Focus®

**195** Logis®/Logis® Classic

**196** Kitchen technologies

---

## **198 Company**

# Quality with added value

---



Quality borne by tradition

**5 YEARS**  
GUARANTEE

Assured quality

**SERVICE**

We are there for you



Trade partner



Worldwide references

**Design**

Number One on the sector



Certified mixers and showers



Water processing



Saving water



Select your shower pleasure



Easy cleaning



Larger, softer drops



Optimal freedom of movement

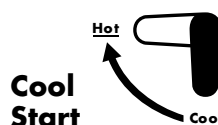

Saving energy

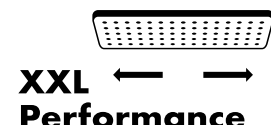

Pure shower pleasure

---

Find out all the latest news on water and Hansgrohe at



[www.facebook.com/hansgrohe](https://www.facebook.com/hansgrohe)



[www.twitter.com/hansgrohe\\_pr](https://www.twitter.com/hansgrohe_pr)



[www.youtube.com/hansgrohe](https://www.youtube.com/hansgrohe)

# Impressive range for the bathroom and kitchen

---

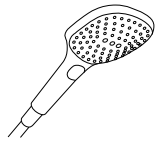

**Hand showers**

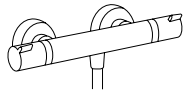

**Exposed shower thermostats**

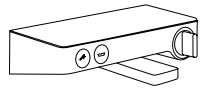

**Exposed bath thermostats**



**Shower sets**

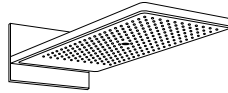

**Rainmaker® Select**

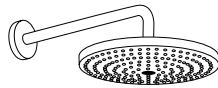

**Overhead showers**

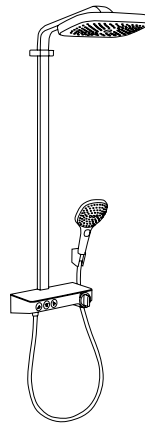

**Showerpipes**

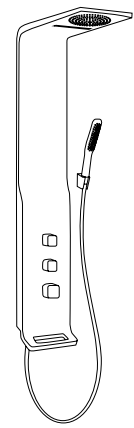

**Showerpanel®**

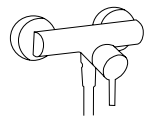

**Exposed single lever shower mixers**

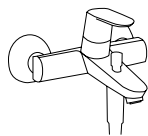

**Exposed single lever bath mixers**

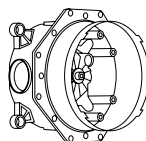

**iBox® universal**

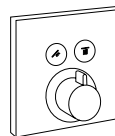

**Concealed thermostats**

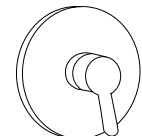

**Concealed single lever shower mixers**

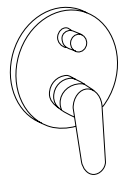

**Concealed single lever bath mixers**



**Valves**

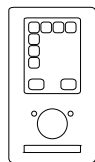

**Electronic shower control**

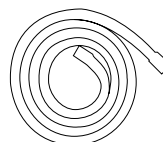

**Accessories**

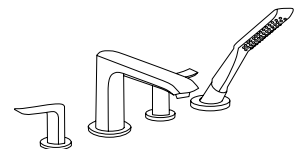

**Rim-mounted mixers**

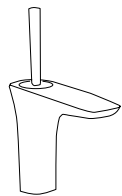

**Basin mixers**

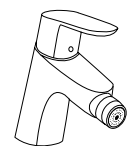
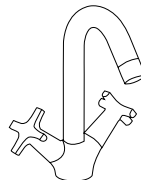
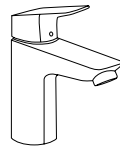
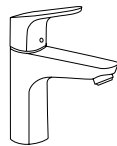
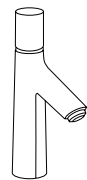
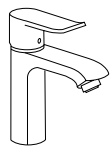

**Bidet mixers**



**Electronic and Care basin mixers**

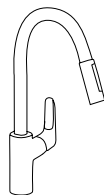
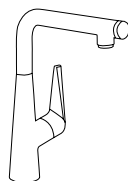
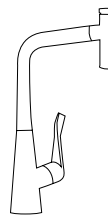
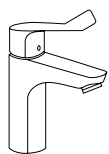

**Kitchen mixers**

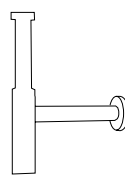

**Waste systems**

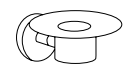

**Accessories**

Made by Hansgrohe

# Quality you can count on: before, during and after installation

We at Hansgrohe see ourselves as retail and trade partners. Our constant ability to offer our customers the highest quality and

tailored services is a fundamental part of our corporate philosophy. No matter whether you have questions, problems, or specific wishes:

We are at your side. You can always put your trust in our quality claim "Made by Hansgrohe". Before, during and after installation.



**Quality borne by tradition:** We build on German expertise for the highest quality in form and function. We see, and have always seen, "Made in Germany" as a recipe for success: indeed the majority of our products are made in the Black Forest. Our goal is to offer our customers long-lasting solutions that set exceptional standards in functionality and quality. Hansgrohe only uses the highest quality materials that are approved for drinking

water applications, and they are subjected to long-term durability tests to assure their compliance with all international bathroom regulatory requirements. All single parts comply with the relevant standards and are fitted with optimal precision for safe ease of use and convenience which will last for many years to come. The guidelines we ourselves have drawn up for product safety exceed by far, most of the specifications usual in this

sector. In addition to the normal tightness tests, our showers are also tested regularly at a pressure of 10 bar. The cartridges in the fittings can even withstand pressure shocks of up to 60 bar. Test certificates from independent institutes confirm the long life and reliable use of our products. So Hansgrohe offers you quality that you can pass on directly to your customers. So you can be assured of their long-term satisfaction.

## 5 YEARS GUARANTEE

**Assured quality:** The highest quality is a fundamental part of the Hansgrohe corporate philosophy. For this reason, we offer a voluntary manufacturer's warranty of five years on all of our products.

<http://pro.hansgrohe-int.com>

## CLEANING AND CARE

**Customers remain happy:** Our products are notable for being easy to clean. One example of this is the QuickClean function that enables limescale to be rubbed off with minimal effort. We also provide various care tips that help your customers enjoy our products for even longer.

<http://pro.hansgrohe-int.com/maintenance>

## ONLINE SPARE PARTS SHOP

**All parts in detail:** The electronic spare parts catalogue lets you find and purchase spare and special parts with particular ease. In addition, you will benefit from other functions like dimension drawings, links between drawings and service parts, a checklist and downloads of installation and service instructions.

<http://spares.hansgrohe.com>

## Hansgrohe@home

**Bath planning made easy:** Show your customers on your iPhone, iPad, or Android smartphone a virtual bathroom where Hansgrohe mixers and showers blend perfectly with their bathroom. iTunes: <http://appstore.com/hansgrohehome> and Google Play: <http://play.google.com/store/search?q=hansgrohe+se>

## Savings Calculator

**Savings with Hansgrohe:** The savings calculator lets you calculate for your customers the potential saving with EcoSmart technology in mixers and showers. You can also determine the return rate on the investment: <http://pro.hansgrohe-int.com/savings-calculator> or mobile at <http://m.pro.savings.hansgrohe-int.com>

## AXOR® MANUFAKTUR

**Tailored products and special solutions:** Besides our many standards, our factory also offers you and your customers bespoke Hansgrohe products – for single or multiple pieces. These enhance the individuality of every bathroom and lend hotel projects that unmistakable, unique and prestigious touch. <http://pro.hansgrohe-int.com/customisation>



## SERVICE

**Trade partner:** Our experience gathered over many years offers you support in the form of a wide range of services. Whether you are in need of services, product training courses, or consultation for special projects or enhanced marketing efficiency for your services, you can only benefit from our extensive expertise. We provide a lot of information on bathroom planning online for you, such as dimension drawings and 3D details.

<http://pro.hansgrohe-int.com/service>

**We are there for you:** Technical questions? Our experienced master technicians will be pleased to offer you advice and support for all of your product and installation queries.

Service hours:

Mon-Fri: 07.00 am – 06.00 pm

Phone: +49 7836 51-1282

Fax: +49 7836 51-1440

Email: [info@hansgrohe-int.com](mailto:info@hansgrohe-int.com)





# Technology to thrill your customers

Once again, Hansgrohe is revolutionising the way we use water – with an elegant button. One click is all it takes to change the spray type or start or stop the water. The name of this innovative technology:

Select. An intuitive control concept at the touch of a button that promises even greater pleasure in the bathroom and kitchen. Whether hand showers, overhead showers, the ShowerTablet surface-mounted thermostat, concealed finish

sets or Showerpipes, basin or kitchen mixers – the new Select technology with its many benefits brings pleasure at the touch of a button.



**Raindance® Select E 300 3jet**  
Overhead shower



**Croma® Select S 180 2jet**  
Overhead shower



**Raindance® Select E 300**  
3jet Showerpipe



**Croma® Select S 180**  
2jet Showerpipe



**Raindance® Select E 120**  
3jet Hand shower



**Croma® Select S Vario**  
Hand shower



**Metris® Select 320**  
Single lever kitchen mixer



**Talis® Select 300**  
Single lever kitchen mixer



**ShowerSelect®**  
Concealed thermostat



**ShowerSelect® S**  
Concealed mixer



**Talis® Select S 100**  
Basin mixer



**Talis® Select E 110**  
Basin mixer



**ShowerTablet® Select 300**  
Exposed shower thermostat

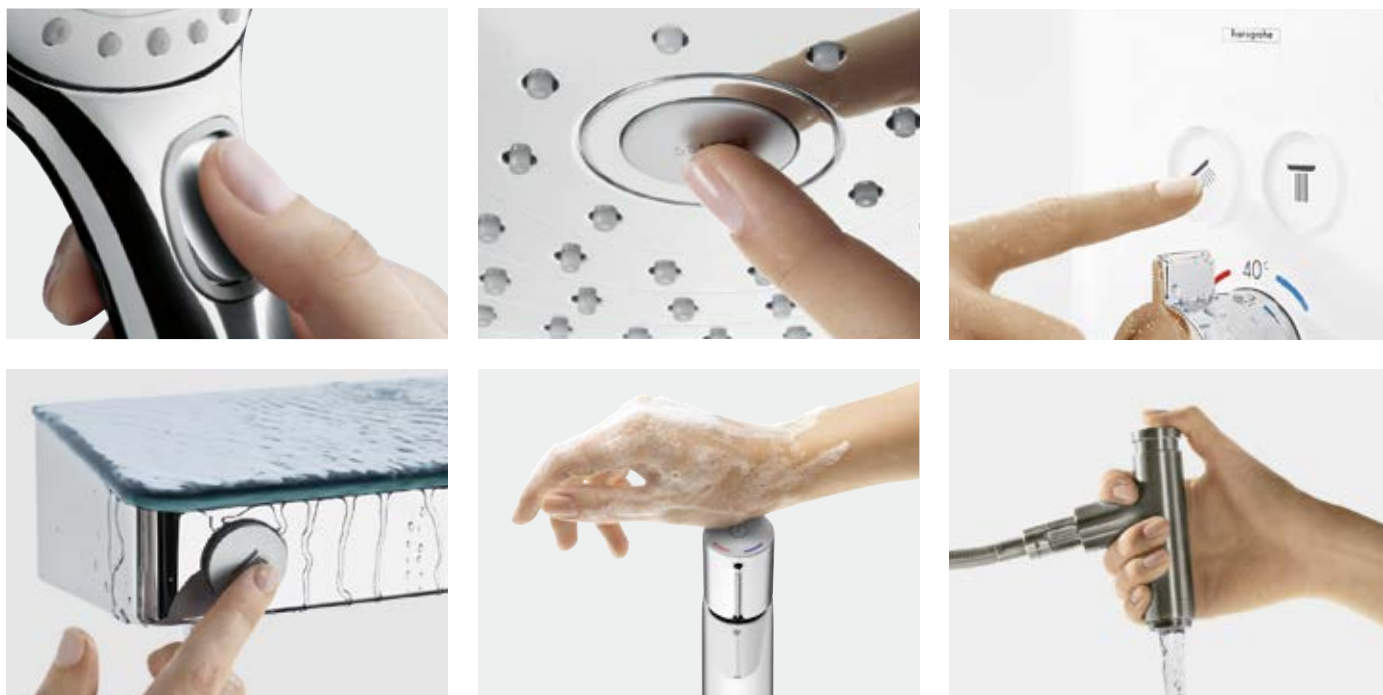

**Versatile:** The Select button has different functions depending on where it is being used: change between shower spray types, select the thermostat function, and start and stop the water on mixers. Depending on the particular product, the Select buttons can even be started with the back of a hand or an elbow. This makes the technology perfect for all ages, and in particular for people with limited mobility.



## Advantages and benefits

- Intuitive control at the touch of a button: a simple click changes the spray type, controls a shower, and turns water on/off
- Ergonomic “universal design” allows easy and reliable use for all generations
- The clever construction complies with all Hansgrohe’s standards, and is tested for lasting durability
- A wide range of multifunctional products for a broad target group
- Consistent control solution for hand and overhead showers, Showerpipes, surface-mounted and concealed thermostats, basin and kitchen mixers

Find out more in the “Select” discussion and at <http://pro.hansgrohe-int.com/select>

Shower solutions with Select technology



# Full shower experience at the touch of a button

Select technology makes showering an even greater pleasure. It only takes a touch of a button to change the spray type or control a shower. The Select button is always mounted

so it is within easy reach while showering. With the hand shower it is on the front of the handle, with the overhead shower right in the middle of the spray face, and with surface-mounted or

concealed controls, on the front of the control unit. The technology is purely mechanical, which means it is particularly durable, inexpensive and is not complicated to install.

## Select for hand and overhead showers

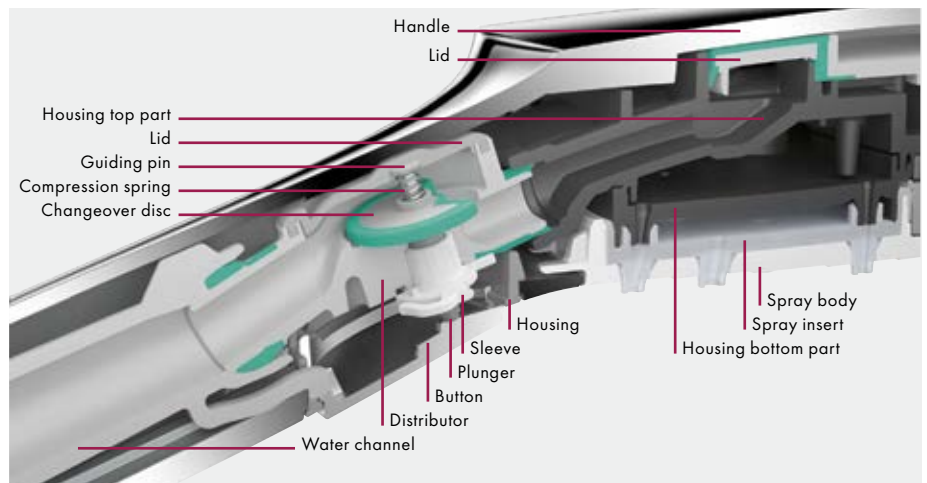

**Hand showers:** Thanks to the revolutionary mechanical construction, the spray can be changed, simply by touching a button. The Select button confirmed its durability in a long-term test that operated it 90,000 times.

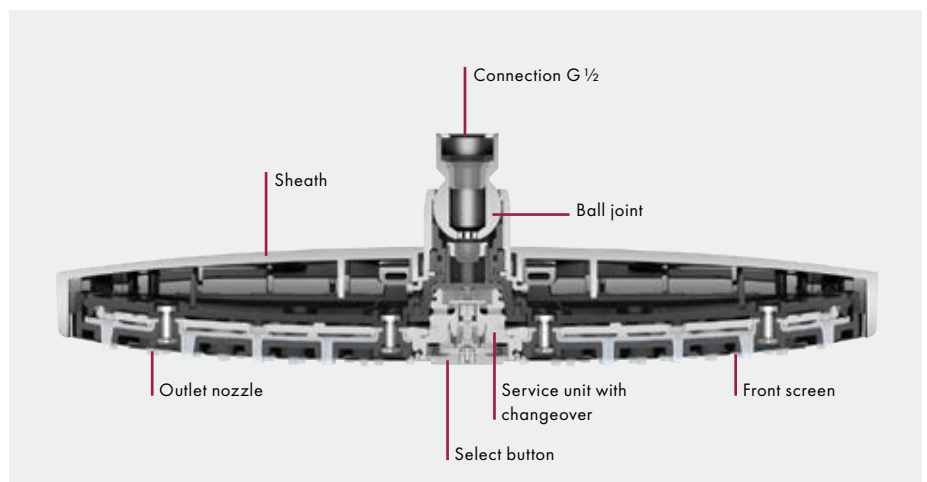

**Overhead showers:** The innovative changeover unit in the overhead shower makes it easy to change the spray following the Select principle. Purely mechanically, at the touch of a button.

**i** Hand showers with Select technology start on page 38.

**i** Overhead showers with Select technology start on page 56.

## Select for surface-mounted and concealed controls

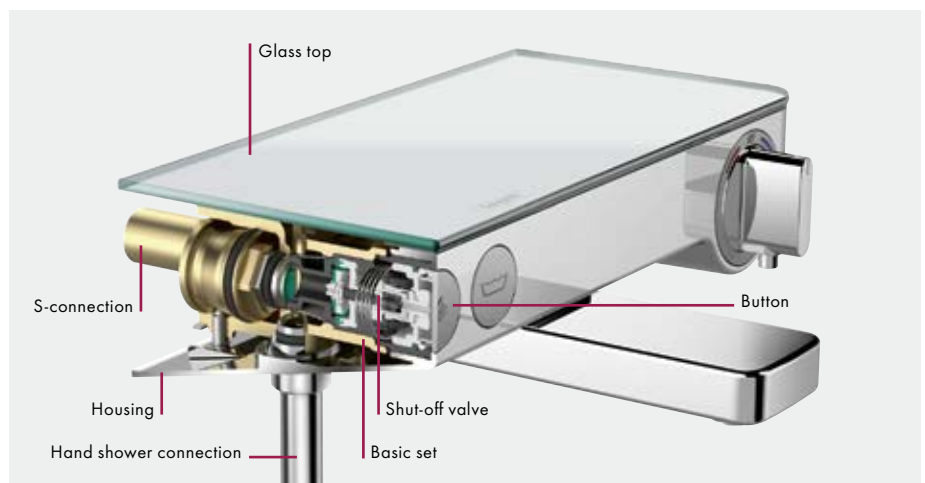

**ShowerTablet/Showerpipe:** Depending on the version, up to 4 functions can easily be operated by the touch of a button – even at the same time. Raised buttons indicate which function is currently active.

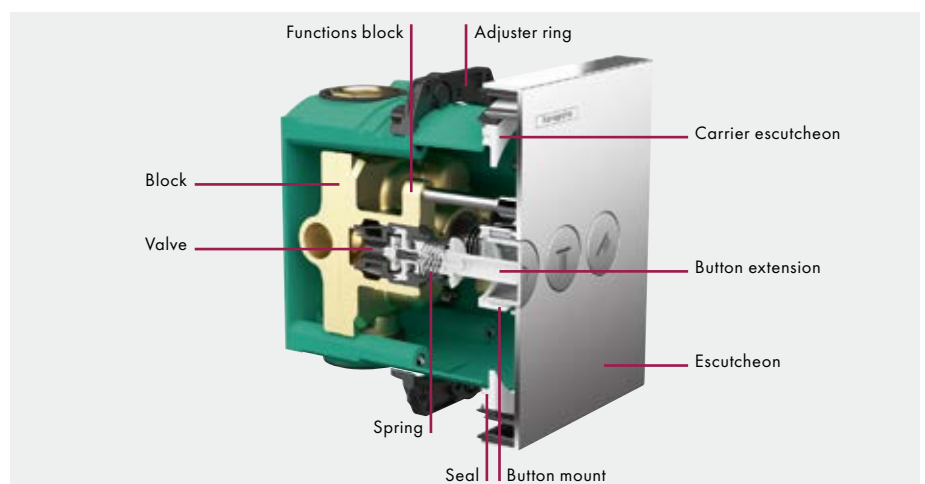

**ShowerSelect finish set:** Easy control of up to 4 functions at the touch of a button – even at the same time. Thanks to the optional button extension, operation is just as easy for users with limited mobility since the buttons then protrude.

Bathroom mixers with Select technology



# A button that answers every question

Easy operation by Select button is now also available for the basin. A single press is all it takes, and the water starts to flow from the tap. Automatically limited to 5 l/min thanks to

EcoSmart technology. Press again, and the water stops – easy to understand and simple for every generation to use. The temperature is selected simply by turning, and remains set

after switching off. Select technology is purely mechanical. Giving your customers years of pleasure with their intuitive button.

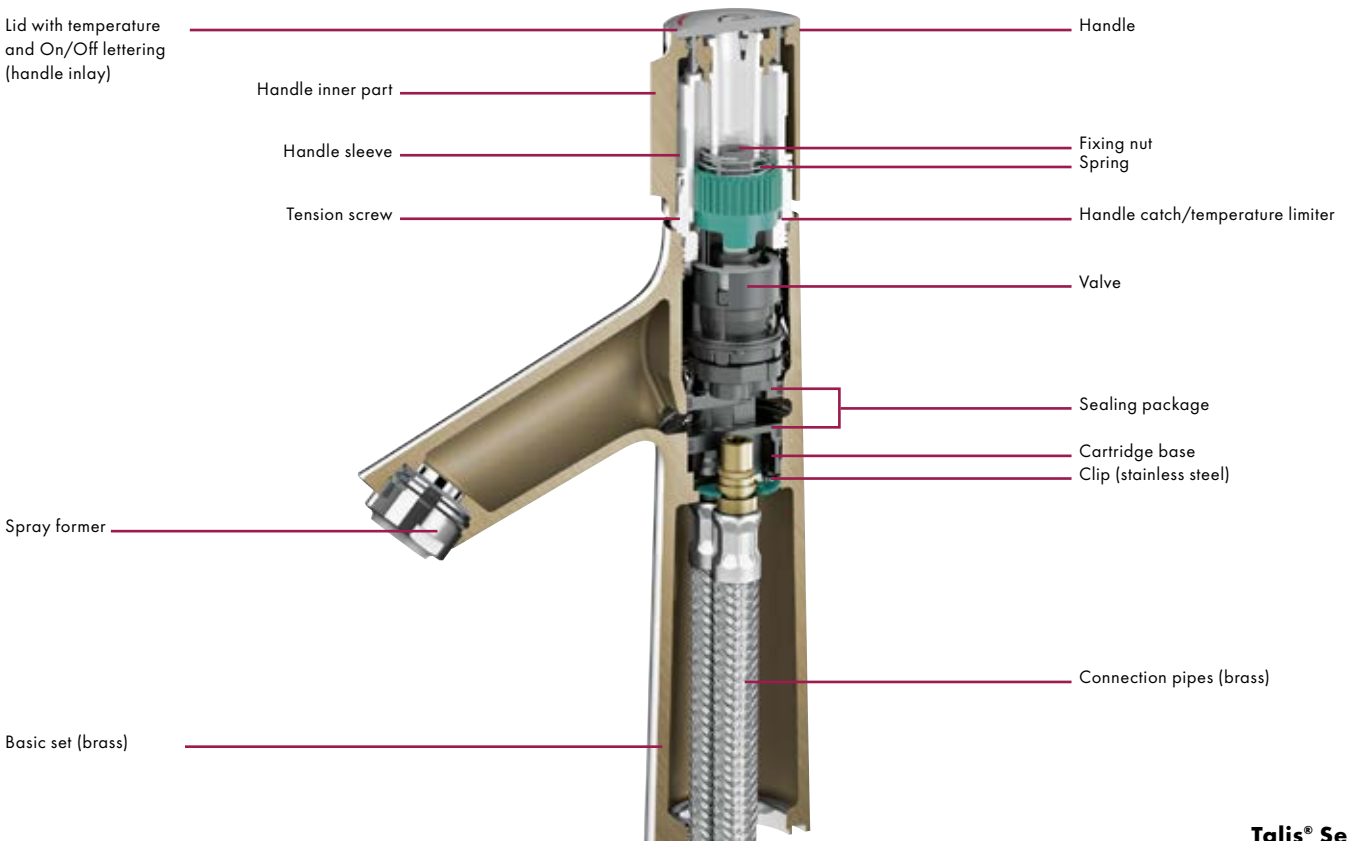

**Talis® Select**



**Innovation:** Its use is so intuitive and runs so smoothly that even children find it easy to handle. In fact, it can even be operated with an arm or elbow.



**Fine form:** The slender Select button facilitates an entirely new design language, opening it up to additional design-orientated target groups.



**Robust:** The purely mechanical Select technology has proven its durability in many challenging long-term tests.

Kitchen mixers with Select technology



# A touch ahead in the kitchen

Washing, chopping, stirring – you have your hands full when you’re cooking. Which is why Select technology is also available for the kitchen. Simply turn the water spray on and off

at the touch of a button, effectively giving you a pause function. The handle remains open, and maintains the pre-set temperature and water quantity. The Select button doesn’t

interrupt the flow of work, and it makes cooking easier and more pleasurable.

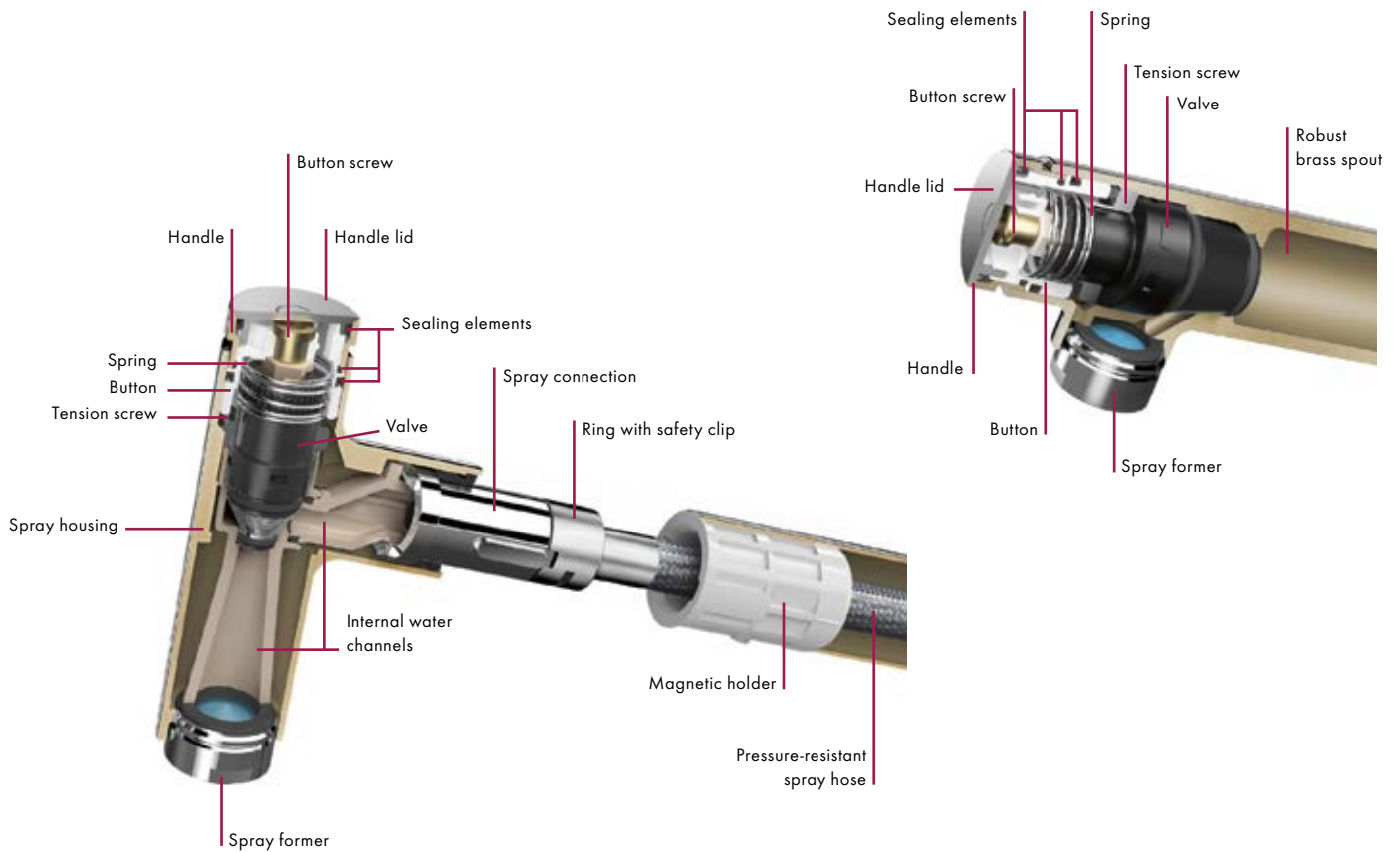

**Metris® Select**

**Talis® Select**



**User-friendly:** The Select button can even be operated if you have your hands full, so you can easily turn the water on and off. Which provides greater flexibility in the kitchen.



**Precise:** It’s even easy to fill containers beside the sink. No contortions or irritating splashes. The water is turned on and off on the pull-out spray at the touch of a button.



**Robust:** Whether on the pull-out spray or the 150° swivel spout, the Select button is purely mechanical, which makes it exceptionally robust.

# SHOWERS AND SHOWER CONTROL

---

**The wide range of products that fulfils all requirements:**

Rainmaker® Select | Hand showers and shower sets | Overhead and side showers  
Showerpipes | Showerpanel® | Thermostats  
iBox® universal | Installation systems



Shower installations

# As individual as your customers

When it comes to the shower, every one of your customers will want something different. But with Hansgrohe you can make all their wishes come true, we offer you a large number of shower combinations, from the simple shower and overhead shower set to the

ensemble of thermostat, hand and overhead shower. The installation options are just as flexible. Whether surface mounted or concealed, Hansgrohe provides the right solution for your needs. In addition, the Showerpipe and Showerpanel can provide

complete systems that turn a shower into something more during refurbishment work. For a larger shower area, the brand new Rainmaker Select range with large overhead showers, glass surfaces and innovative Select control will integrate perfectly.

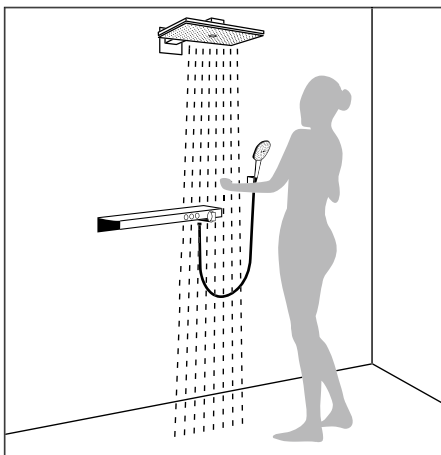

**Rainmaker® Select:** The individual complete solution for large showers. Large overhead showers with a glass spray face in combination with innovative mixers are an expansive showering delight. More on pages 20 and 58.



**Hand shower or shower set:** Even the basic solution provides pure shower pleasure for customers and moreover can be attached effortlessly to the wall. Controlled via exposed thermostat or single lever shower mixer. More on page 38 onwards.

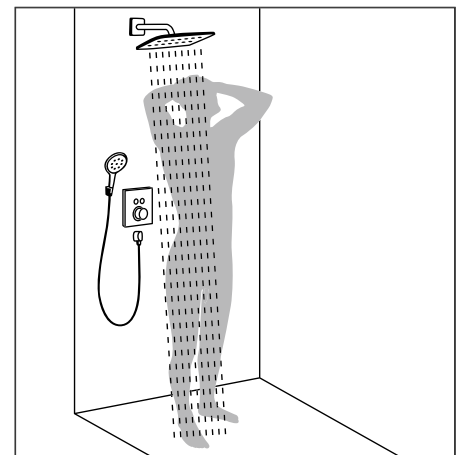

**Overhead shower:** For shower rain modes up to 600 mm in diameter, controlled via concealed thermostat or valves. The version with Select technology promises even greater convenience. More on pages 20 and 56 onwards.

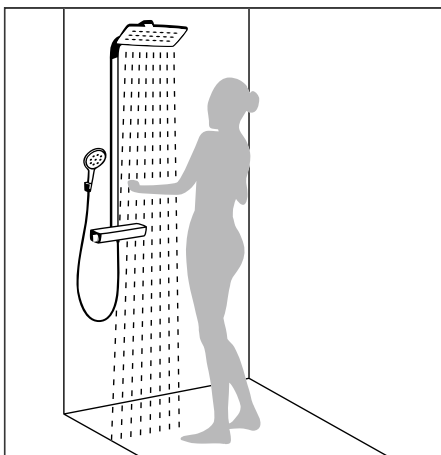

**Showerpipe:** The complete system with overhead shower, hand shower and thermostat. The ideal solution for uncomplicated bathroom refurbishments. More on pages 70 onwards.

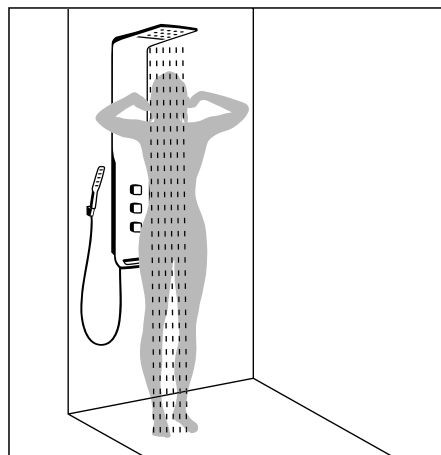

**Showerpanel®:** Combines overhead, hand, and/or side showers in a single system. This can be installed on existing wall connections. Hence also ideal for retrofits and refurbishments. More on pages 86 onwards.

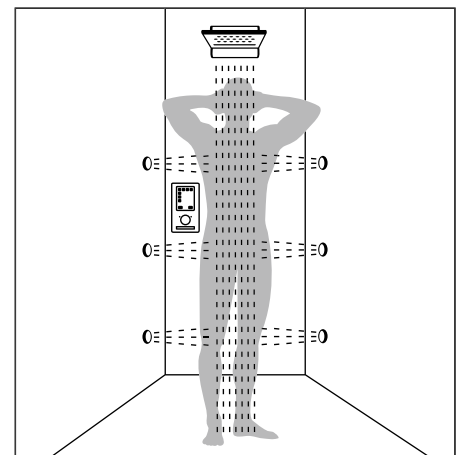

**Shower family:** The concealed solution for individual shower designs. From a waterfall to all-round pleasure with side showers. Controlled, for example, via the intelligent RainBrain. More on page 98 onwards.



## Spray modes

# Greater enjoyment with the many spray types for hand and overhead showers

Everyone showers differently, and everyone has different expectations of the perfect shower. Some think it not only as a necessity but also a way to relax. Others value

an energising, invigorating shower experience. No matter what your customers' wishes, every one of them will find the right hand or overhead shower and the right spray type in the

Hansgrohe range. The Select products promise your customers particular convenience. They can then select each spray type easily at the push of a button.



**Rain and Rain XL:** The openings on the hand or overhead shower may be small, but their effect is all the greater: The rain spray revitalises and refreshes with its pleasant power enveloping the body. It is therefore ideal, for example, for rinsing out shampoo quickly and thoroughly.



**RainAir:** If you are looking for relaxation and you want your soul to be pampered by the water. Just the right thing for this is a hand or overhead shower with the soft, luxurious RainAir spray that provides air-enriched drops from a large, wide jet, to wash your cares away.



**SoftRain:** The gentle SoftRain water spray gently wraps itself around the body. A treat for the skin – and for the soul, of course. Whether a daily shower or for relaxation, the SoftRain spray is always the right choice. Its strengths come into their own in a quick shower in the morning and in a long soak in the bath after a hard day.



**IntenseRain:** Rinsing out shampoo is easy with the strong IntenseRain water spray. Perfect for setting yourself up for the day. The IntenseRain spray not only rinses out shampoo, but it also washes morning tiredness down the drain – for a refreshing start to the day.



**TurboRain:** The all-purpose tool for quick results: The revitalising TurboRain spray lives up to its name. The pure power of the most powerful of all Rain sprays provides a refreshing shower experience. For those who like things to be quick and straightforward.



**Mix:** Gentle and dynamic at the same time. The mix spray combines the rich, soft RainAir spray with the strong, revitalising CaresseAir spray. Soft drops wrap themselves around the body, while a warm targeted water flow in the middle massages the skin. The perfect combination for daily showering pleasure.



**Whirl:** The concentrated Whirl spray simply washes away the exertions of the day. Whether hand or overhead shower: Three single sprays revolve around each other for an intense massage effect that dissolves tension.



**CaresseAir:** Five strong single sprays combine in a revitalising, strong massage spray for pleasant relaxation. Just the thing after exercise or a hard day at work – good as new in minutes.



**Massage:** A concentrated spray that simply washes the day's stress away. The targeted spray easily relaxes tense areas. The innovative circular arrangement of the sprays turns the shower into a mobile wellness treatment for the home bathroom.

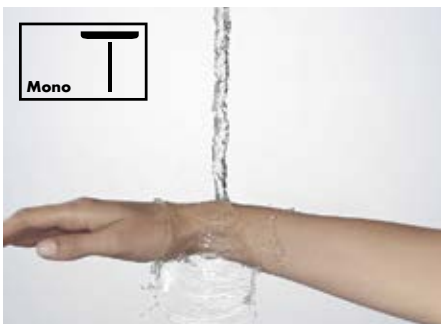

**Mono:** A targeted, soothing relaxation spray from the centre of the shower. The lightness of the Mono spray helps you to unwind, making it the perfect spray for relaxing.



**RainFlow:** An overhead shower with the clear, beautifully shaped RainFlow cascading spray brings the waterfall experience to the bathroom. This lets you enjoy water in its natural form, as a cascade from above on the neck and shoulders. This can be directed specifically to these parts of the body and tension quickly disappears. This is a trend especially in the wellness bathroom.



**RainStream:** The new RainStream of single sparkling jets is a crowning achievement of the Hansgrohe spray developers. These special overhead shower sprays do not constrict, but remain unvaryingly revitalising and intense right down to the floor. The result: a new, revitalising shower experience, irrespective of the users height.



## AirPower: more volume, more pleasure

Convenience and efficiency don't have to be mutually exclusive. This is proved by Hansgrohe AirPower showers. This technology developed by Hansgrohe involves drawing in

air over the whole area of the spray face. Water can then be used with greater efficiency. At the same time, the drops are fuller, lighter and softer. The result can be felt immediately

on the skin: The sparkling AirPower shower rain envelops the body and generates a magnificent well being.



**AirPower:** The generous injection of air gives rise to extraordinary shower pleasure and large, luxurious shower drops.



### Advantages and benefits

- Fuller, lighter and softer drops - pure shower pleasure
- Fewer splashes, so less cleaning
- Larger water volume for greater water efficiency

## QuickClean: fast anti-limescale function



**QuickClean:** Thanks to the flexible silicone jets, dirt and limescale simply wipe away with a finger.



### Advantages and benefits

- Fast and easy cleaning
- Ultra high quality and tear resistant silicone
- For a long lifetime and functionality

## XXLPerformance: great shower pleasure



**XXLPerformance:** The generously-proportioned shower experience with air-enriched, lavish drops and the surprisingly low water consumption.



### Advantages and benefits

- Shower rain modes up to 600 mm in diameter
- High water efficiency - a uniformly distributed spray for an incomparable showering experience



## Select: showering pleasure at the touch of a button.

It is easier to push than to turn. The innovative Select technology transfers this thought to the hand and overhead showers and the shower control. With an elegant button that only requires a single click to change the spray type or control the water. For even greater

pleasure when showering – for all ages.



**Select:** Operation at the touch of a button on hand and overhead showers, Showerpipes and surface-mounted and concealed thermostats provide even more comfort.



### Advantages and benefits

- Intuitive control at the touch of a button
- More comfort for every generation
- Mechanical construction for permanent functional safety

## EcoSmart: water and energy savings

Hansgrohe EcoSmart showers consume up to 60% less water than conventional products. This reduces water and energy costs and protects valuable resources, which is confirmed by the best possible rating of our hand showers Crometta 85 Green and Croma

100 (1jet, Vario, and Multi) by the European quality mark WELL – Water Efficiency Label.



**EcoSmart:** The ingenious flow rate limiter in the shower reduces water consumption to only 9 or 6 l/min.

WELL Upgrade Volume Water Efficiency Label	
Manufacturer:	Hansgrohe SE
Product category:	Accessories shower valve
Type:	Shower head
Model:	Crometta 85 Green
Registration number:	ZD1056420130704
<div style="display: flex; justify-content: space-between;"> <div> <p>A</p> <p>B</p> </div> <div style="border: 1px solid black; padding: 2px;"> <p><b>A**</b></p> </div> </div>	
<b>Water Efficiency Criteria</b> Flow rate > 9.0 l/min ≤ 12.0 l/min * Controlled flow rate ≥ 4.5 l/min ≤ 9.0 l/min **	
<small>Information about use and installation: <a href="http://www.wellonline.eu">www.wellonline.eu</a>.                      A Label of EU United Values                      European Valve Manufacturers Association</small>	



### Advantages and benefits

- Up to 60% less water consumption
- Hot water savings for less energy consumption – so less CO<sub>2</sub> emissions and lower costs



How much water and energy can be saved is calculated by the savings calculator at:

<http://pro.hansgrohe-int.com/savings-calculator>

Rainmaker® Select

**NEW**

## Extra-large showering pleasure

A clear trend is becoming obvious in the modern bathroom: The bath is becoming less important, while the shower area is becoming bigger and the centre of the bathroom. At the same time, the desire for homeliness, freedom

of movement and lasting material quality is growing. Meet these increased requirements with the new Rainmaker Select overhead showers and visually matching control elements. Spray widths of up to 580 mm,

elegant glass surfaces and integrated storage surfaces or control at the touch of a button make the extended shower room something very special. For extra-large showering pleasure.



**Complete:** From overhead showers with spray widths of up to 580 mm, to intelligent concealed controls and Showerpipes to the first surface-mounted thermostat that also controls single-spray overhead showers to G ½ wall connections, the new complete system for large showers provides your customers with fabulous balanced solutions.

### Concealed installation:



Rainmaker® Select overhead showers

+



ShowerSelect® concealed thermostats

### Surface-mounted installation:



Rainmaker® Select Showerpipes

### Surface-mounted/concealed installation:



Rainmaker® Select overhead showers

+



ShowerTablet® Select 700

## Glass – the connecting element in large showers

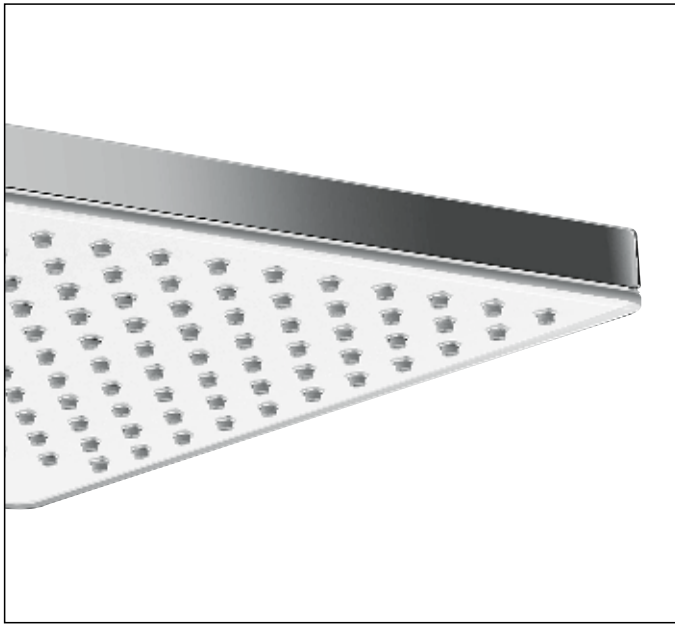

**A highlight in the bathroom:** Glass is the most natural material to go with water. There's a good reason why we prefer to use glass bottles and glasses for refreshment. Glass appeals because of its elegant, precise looks, and appeals with other advantages such as hygiene, scratch resistance and being easy to clean. It can cope with any chemical cleaners, which makes it perfect for hotels. In the Rainmaker Select range, glass is the central design feature. This provides harmonious

links with other bathroom elements in large and small shower areas. On the one hand, with glass objects such as mirrors or shower partitions, and on the other with the white/chrome colouring that goes happily with PuraVida products. Close attention is paid to every detail in production to ensure the attractive appeal. Lasering and burning the glass are both signs of excellent quality – quality that can be seen and felt with every shower.



### Advantages and benefits

- Cleverly designed spatial range for large showers
- Matching colours and design language for a harmonious bathroom ambience
- Comfortable ambience thanks to exclusive, long-lasting materials such as glass and chrome-plated metal
- Special architectural design appeals to more design conscious customers

Rainmaker® Select overhead showers

**NEW**

# The new star in the shower sky

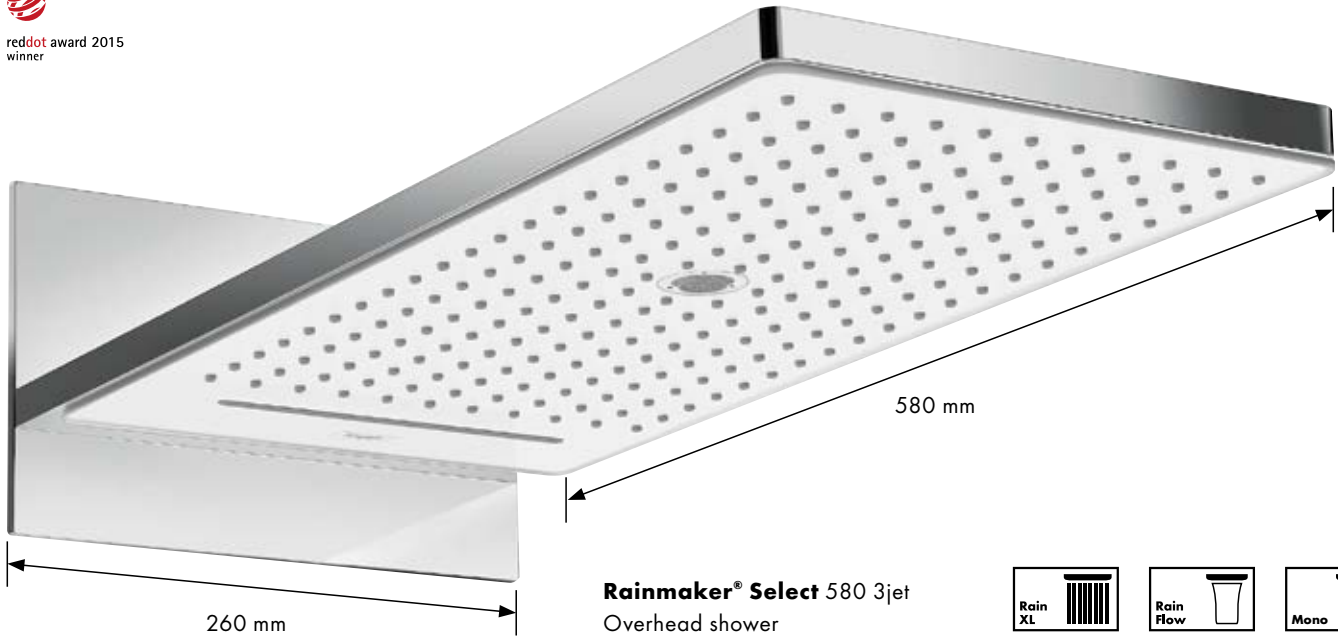

**Rainmaker® Select 580 3jet**  
Overhead shower

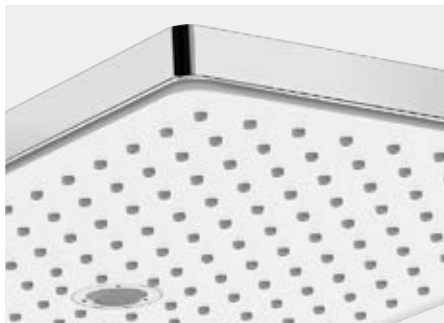

**Exclusive:** Safety glass surface with lasered spray openings.



**Mono:** A targeted spray for showering pleasure that also refreshes.



**RainFlow:** A full flood spray for a refreshing shower.



## Advantages and benefits

- Unique: Glass spray faces in impressive sizes
- Spray widths of up to 580 mm perfectly fill the large shower area
- Height-variable wall mounting based on the iBox universal for optimum spray intensity of RainFlow or RainStream
- The generous proportions of the overhead shower make it a prominent feature in the bathroom
- Generous white surfaces integrate harmoniously in the ceiling, and look light and elegant

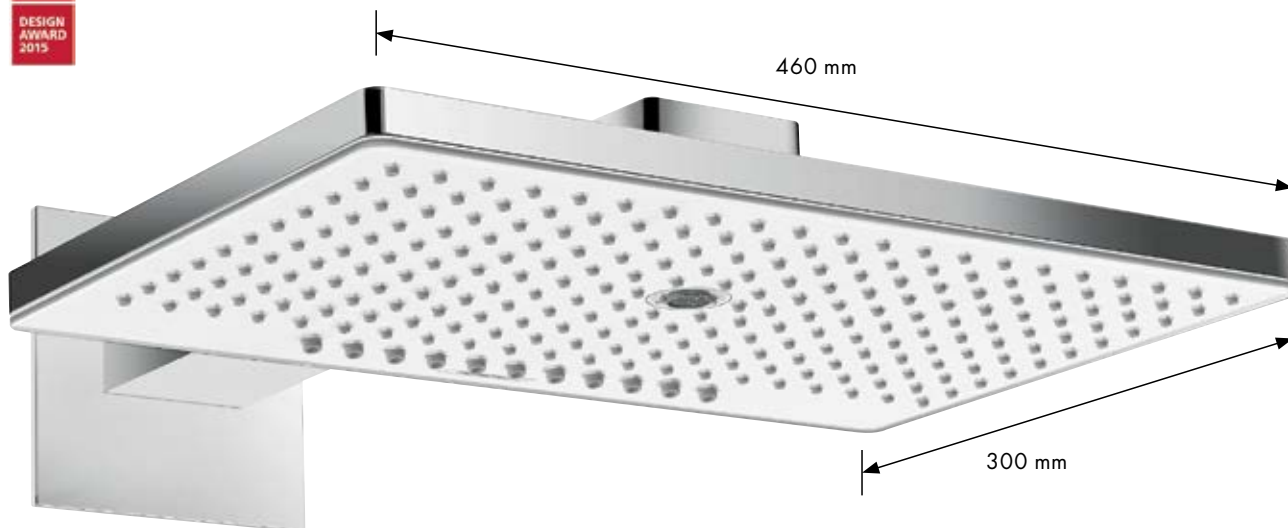

**Rainmaker® Select** 460 3jet  
Overhead shower



**Flexible:** Also available for ceiling mounting, where it can be positioned freely anywhere in the room.



**Easy cleaning:** Thanks to the QuickConnect holder, the overhead shower can easily be fitted or removed for cleaning by one person - no tools required.

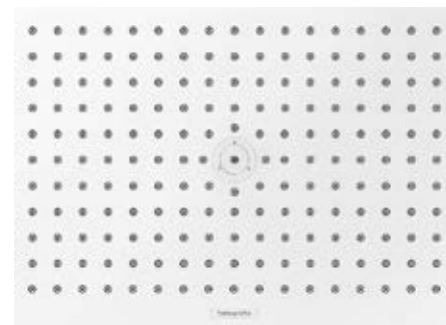

**Permanent:** The spray face is cut by laser, the colour and lettering applied to the back and permanently fused to the glass.

- **Easy to clean,** durable and a high level of hygiene thanks to the level, hard surface in 4 mm safety glass
- Choice of versions with 1-3 spray types
- New surface-mounted/concealed installation of the single-spray overhead shower also possible with ShowerTablet Select 700. The storage surface is built in.
- Also available in the EcoSmart version with only 9 l/min



ShowerSelect® Concealed thermostat

# Glass and comfort in harmony



**Harmonious:** Perfect integration in the bathroom thanks to the interplay with shower partitions, mirrors and windows.

**Elegant:** Flush-fit buttons blend smoothly with the overall appearance.

**Timeless:** The glass finish has a unique character bringing depth and aesthetic appeal to attract the most design conscious of customers.

**Impressive:** High-quality safety glass surfaces and metal escutcheon.



**Intuitive:** Easy-running Select buttons provide operation at the touch of a button for any generation.



**User-friendly:** Slim pin handle with an eye-catching temperature display for easy, comfortable setting of the desired temperature.



**Easy cleaning:** Cleaning is as easy as ABC thanks to the smooth glass surface and precision shapes.



## Advantages and benefits

- Solutions available for 1-4 functions
- Looks match the Rainmaker Select showers for a harmonious bathroom ambience
- Also easy to combine with chrome showers
- Refurbishment is quick and easy, simply by exchanging the existing finish sets directly on the iBox universal
- Functions can be switched off quickly and easily to save water

ShowerTablet® Select 700 surface-mounted/concealed thermostat

# More space for pleasure

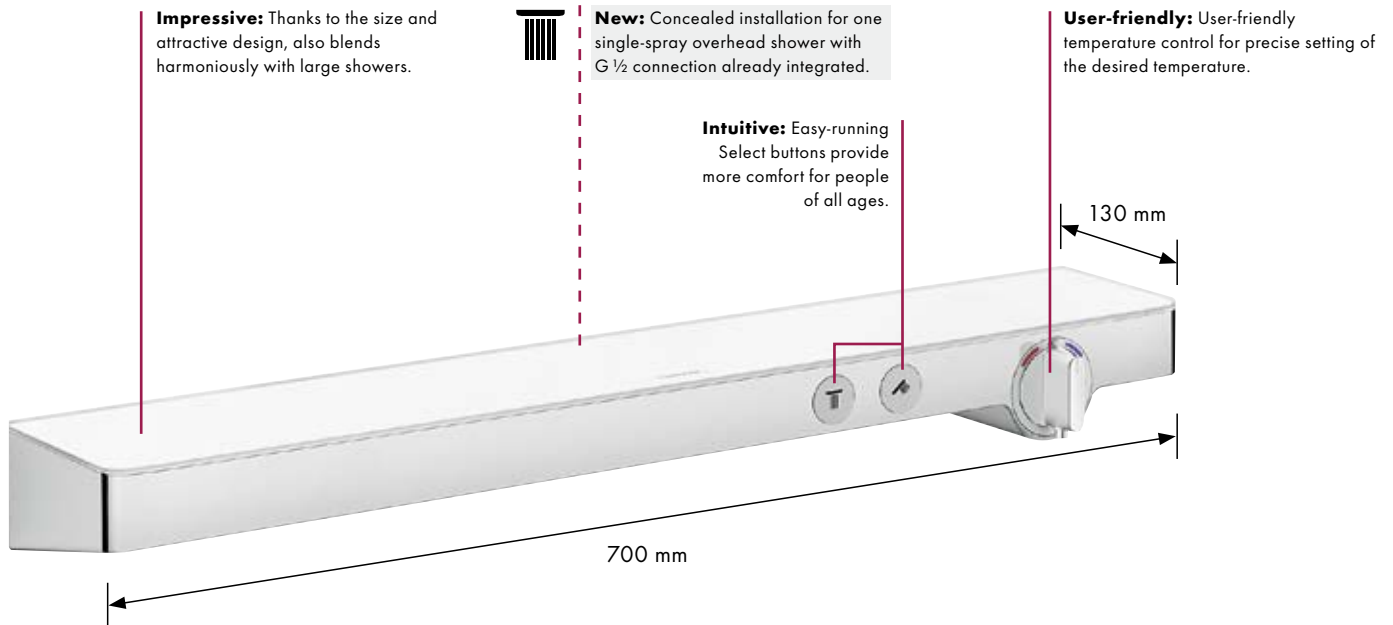

**Generous:** 700 mm wide shelf made of safety glass for more storage space.



**Flexible:** The ShowerTablet Select is also available as a bath version.



## Advantages and benefits

- Hansgrohe's first surface-mounted thermostat to control a single-spray overhead shower via concealed installation (G ½)
- Plenty of storage space thanks to the 700 mm width
- Visual highlight and easy to clean thanks to the high-quality glass surface
- Functions change easily at the touch of a button, symbols easy to understand

Rainmaker® Select 460 3jet Showerpipe

# For deluxe showering pleasure



**Easy cleaning:** High-quality glass surface, completely even and so easy to clean.



**Mono:** A targeted spray for showering pleasure that also refreshes.



**Rain XL:** Rain spray over the entire area of the spray face for large-scale showering pleasure.



**RainStream:** Eleven jets of sparkling water that run parallel right down to the floor. For the same fascinating shower effects at every installation height so you enjoy the same refreshing shower however tall you are.



**Select**  
Select the spray types

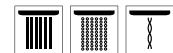

**Select**  
Easy operation of the hand shower and spray types at the touch of a button

Setting the temperature



## Advantages and benefits

- Different versions with different overhead showers for complete showering pleasure in large showers
- Intuitive control concept, pleasure at the touch of a button
- Practical 700 mm wide storage shelf
- **Easy to clean** thanks to the large, even surfaces
- Easy installation with the thermostat, overhead and hand showers in a single system
- Ideal for modernisations, since it can be fitted to existing wall connections and for large shower areas



### **Installation 2 functions**

ShowerTablet® Select 700 with 1 spray overhead shower Rainmaker® Select 460 1jet and Raindance® Select S 120 3jet hand shower



**Components**

Mixers

- Ⓑ Thermostat ShowerTablet Select 700 # 13184, -400

Showers

- Ⓐ Overhead shower Rainmaker Select 460 1jet # 24003, -400
- Ⓒ Hand shower Raindance Select S 120 3jet # 26530, -400
- Porter 'S shower holder # 28331, -000
- Ⓓ Isiflex shower hose # 28271, -000
- Ⓔ Raindrain XXL waste system # 60067, -000

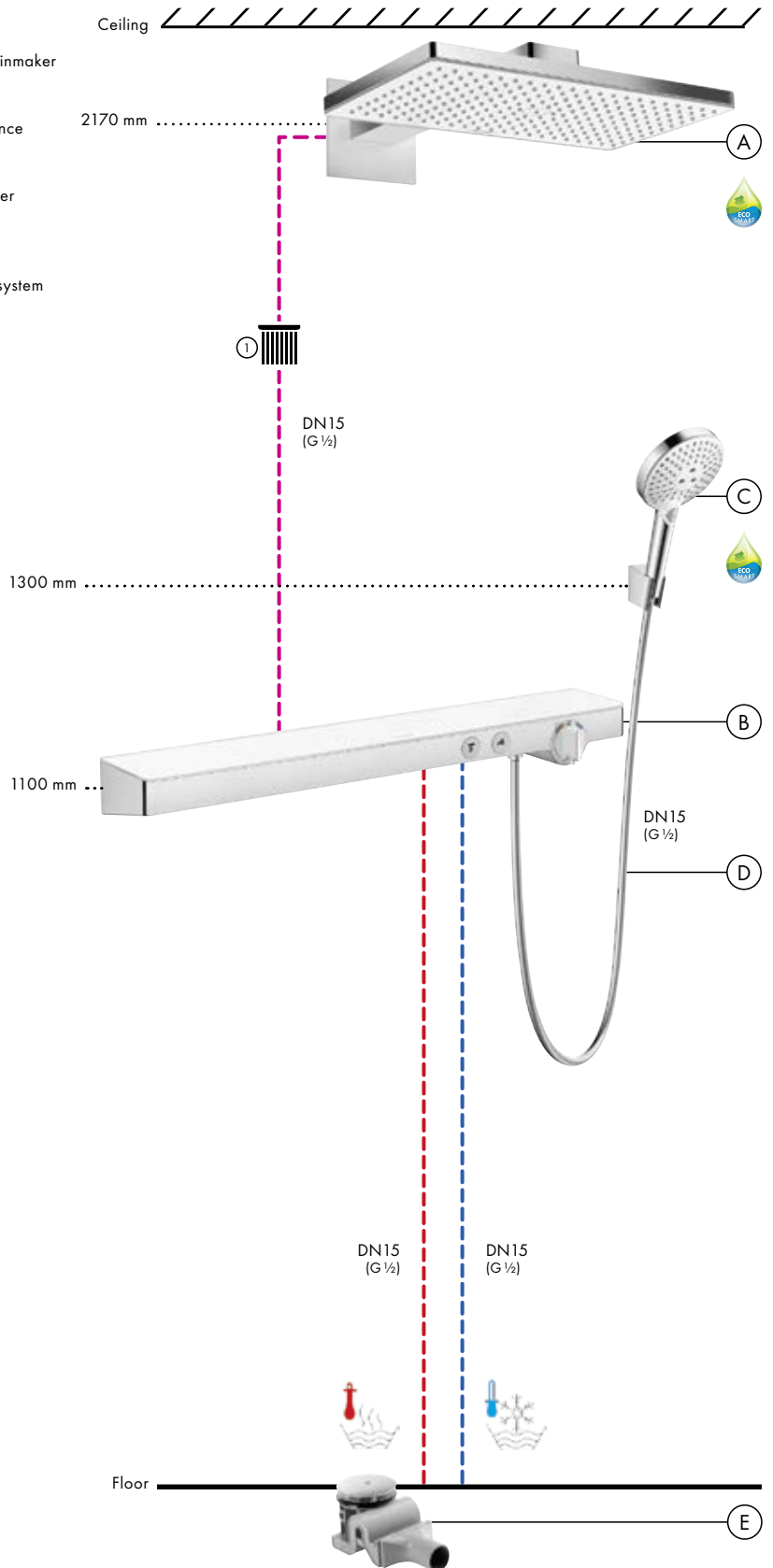

**Flow diagram**

Overhead shower Rainmaker Select 460 1jet # 24003, -400

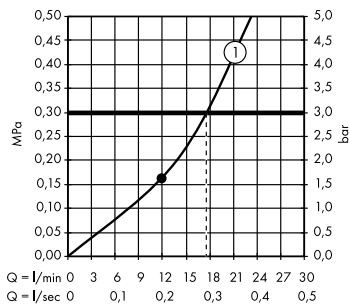

**Legend**

- Ⓛ Rain XL

**Flow diagram**

Hand shower Raindance Select S 120 3jet # 26530, -400

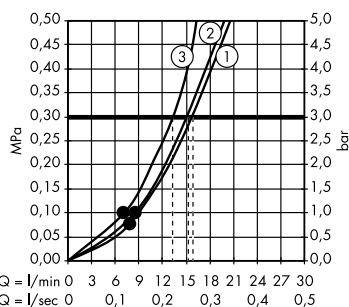

**Legend**

- Ⓛ RainAir
- Ⓜ Rain
- Ⓨ Whirl

• denotes minimum operating pressure

### **Installation 2 functions**

ShowerSelect® thermostat concealed with 1 spray overhead shower Rainmaker® Select 460 1jet and Raindance® Select S 120 3jet hand shower



**Components**

Mixers

- (B) Basic set iBox universal  
#01800180  
Thermostat ShowerSelect  
for 2 functions  
#15738, -400

Showers

- (A) Overhead shower Rainmaker  
Select 460 1jet  
#24003, -400
- (C) Hand shower Raindance  
Select S 120 3jet  
#26530, -400  
Porter 'S shower holder  
#28331, -000
- (D) Isiflex shower hose  
#28271, -000  
Shower connection Fixfit Square  
#26455, -000
- (E) Raindrain XXL waste system  
#60067, -000

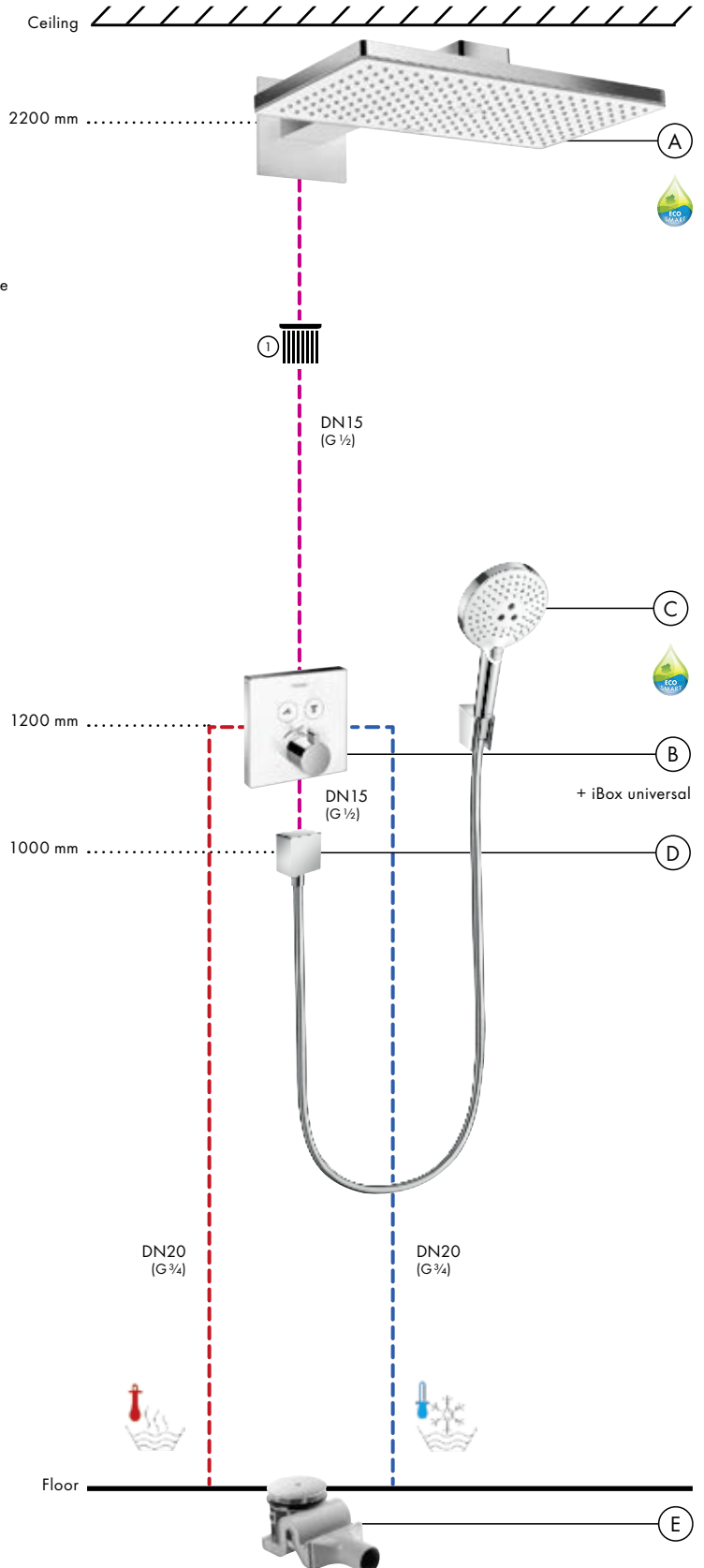

**Flow diagram**

Overhead shower Rainmaker Select 460 1jet  
#24003, -400

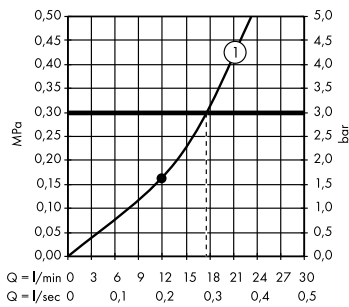

**Legend**

- (1) Rain XL

**Flow diagram**

Hand shower Raindance Select S 120 3jet  
#26530, -400

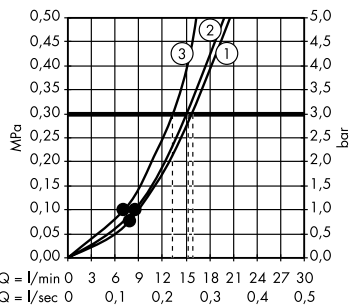

**Legend**

- (1) RainAir
- (2) Rain
- (3) Whirl

• denotes minimum operating pressure



### **Installation 3 functions**

ShowerSelect® thermostat concealed with 2 spray overhead shower Rainmaker® Select 460 2jet and Raindance® Select S 120 3jet hand shower



**Components**

Mixers

- (C) Basic set iBox universal  
# 01800180  
Valve ShowerSelect for 3 functions  
# 15736, -400
- (D) Basic set iBox universal  
# 01800180  
Highflow Thermostat ShowerSelect  
# 15734, -400

Showers

- (A) Basic set iBox universal  
# 01800180  
Overhead shower Rainmaker  
Select 460 2jet  
# 24005, -400
- (B) Hand shower Raindance  
Select S 120 3jet  
# 26530, -400  
Shower holder/Shower connection  
Fixfit/Porter Square  
# 26486, -000  
Isiflex shower hose  
# 28271, -000
- (E) Raindrain XXL waste system  
# 60067, -000

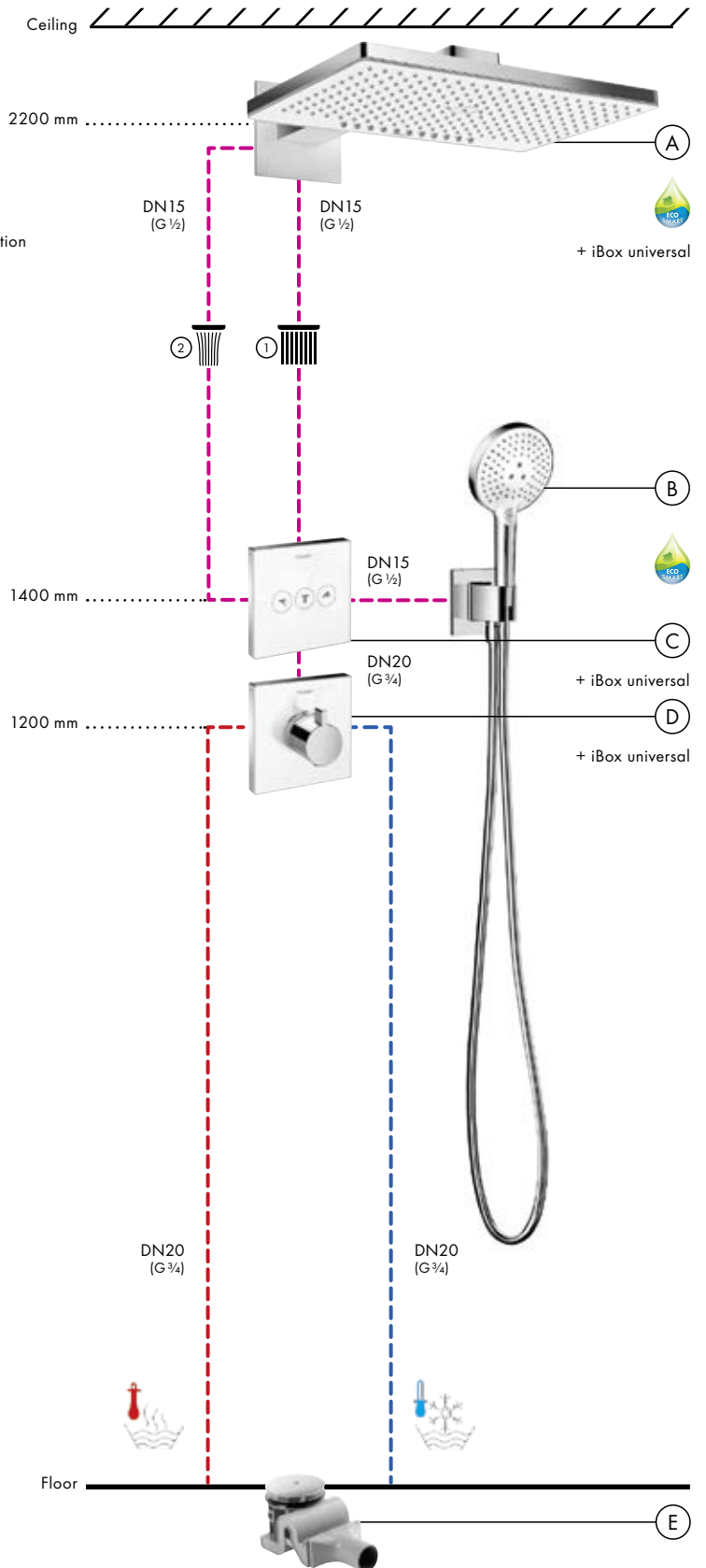

**Flow diagram**

Overhead shower Rainmaker Select 460 2jet  
# 24005, -400

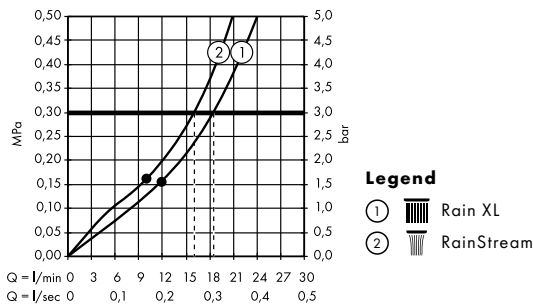

**Legend**

- (1) Rain XL
- (2) RainStream

**Flow diagram**

Hand shower Raindance Select S 120 3jet  
# 26530, -400

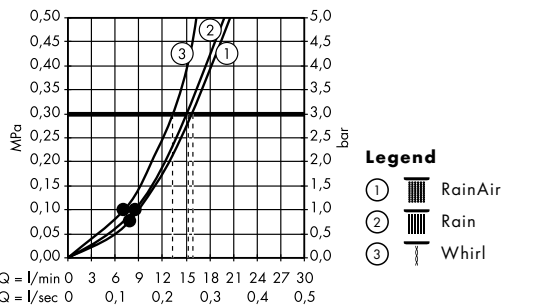

**Legend**

- (1) RainAir
- (2) Rain
- (3) Whirl

• denotes minimum operating pressure

### **Installation 4 functions**

ShowerSelect® thermostat concealed with 3 spray overhead shower Rainmaker® Select 580 3jet and Raindance® Select S 120 3jet hand shower



**Components**

Mixers

- (C) Basic set iBox universal  
#01800180  
Valve ShowerSelect for 3 functions  
#15736, -400
- (D) Basic set iBox universal  
#01800180  
Highflow Thermostat ShowerSelect  
for 1 function (top) and one  
additional function (bottom)  
#15735, -400

Showers

- (A) Basic set iBox universal  
#01800180  
Overhead shower Rainmaker  
Select 580 3jet  
#24001, -400



- (B) Hand shower Raindance  
Select S 120 3jet  
#26530, -400  
Porter 'S shower holder  
#28331, -000  
Isiflex shower hose  
#28271, -000
- (E) Shower connection Fixfit Square  
#26455, -000
- (F) Raindrain XXL waste system  
#60067, -000

**Flow diagram**

Overhead shower Rainmaker Select 580 3jet  
#24001, -400

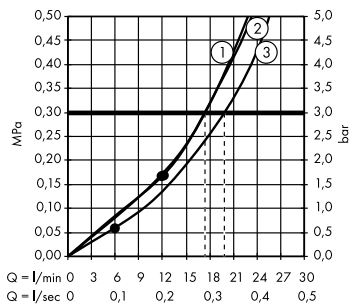

**Legend**

- (1) Rain XL
- (2) RainFlow
- (3) Mono

**Flow diagram**

Hand shower Raindance Select S 120 3jet  
#26530, -400

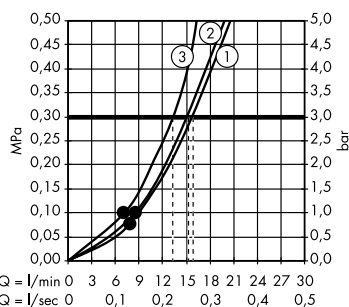

**Legend**

- (1) RainAir
- (2) Rain
- (3) Whirl

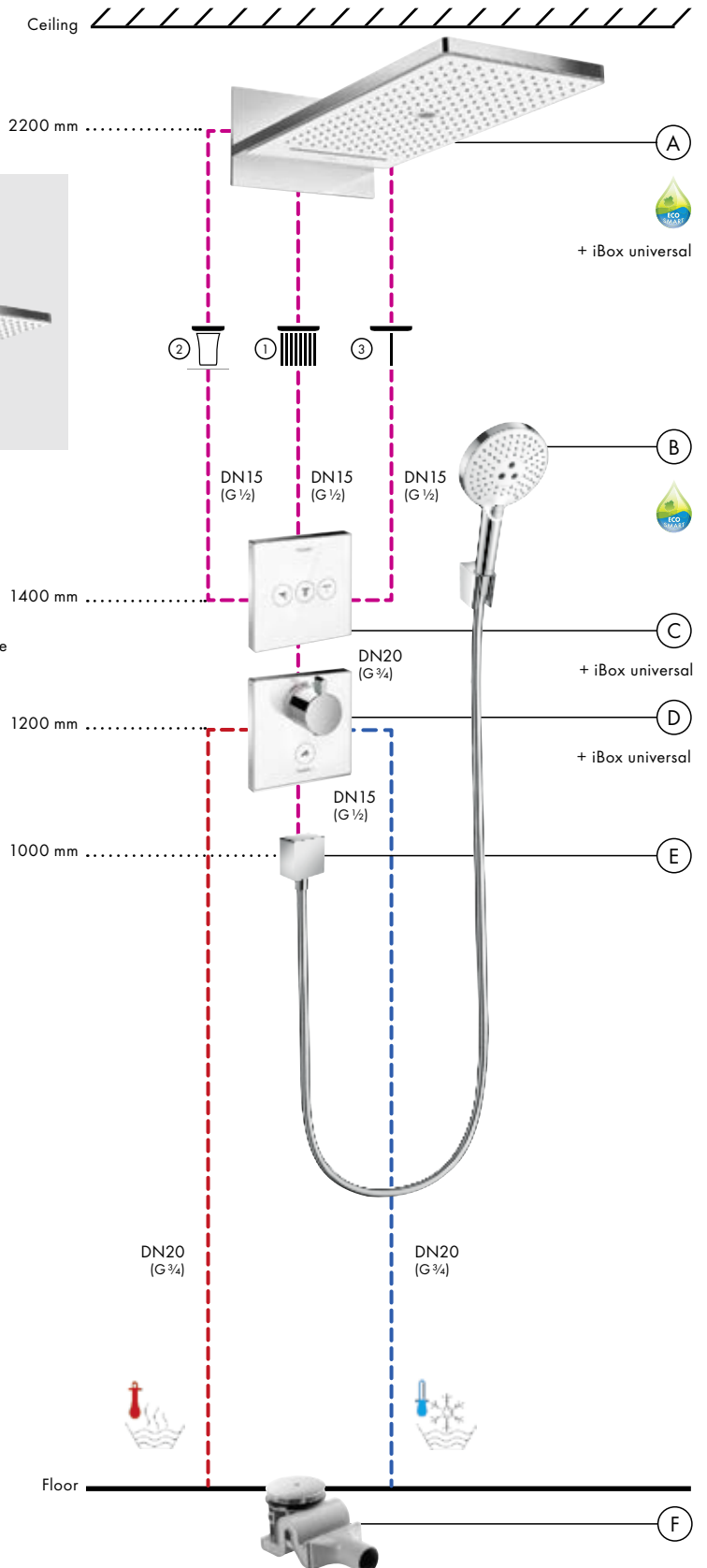

• denotes minimum operating pressure

**Bath installation:**

ShowerTablet® Select 700 bath thermostat exposed with Raindance® Select S 120 3jet hand shower



**Components**

Mixers

- Ⓐ ShowerTablet Select 700 bath thermostat  
# 13183, -400

Showers

- Ⓑ Hand shower Raindance  
Select S 120 3jet  
# 26530, -400  
Porter 'S shower holder  
# 28331, -000  
Isiflex shower hose  
# 28271, -000
- Ⓒ Waste und overflow set Flexaplus  
# 58143, -000

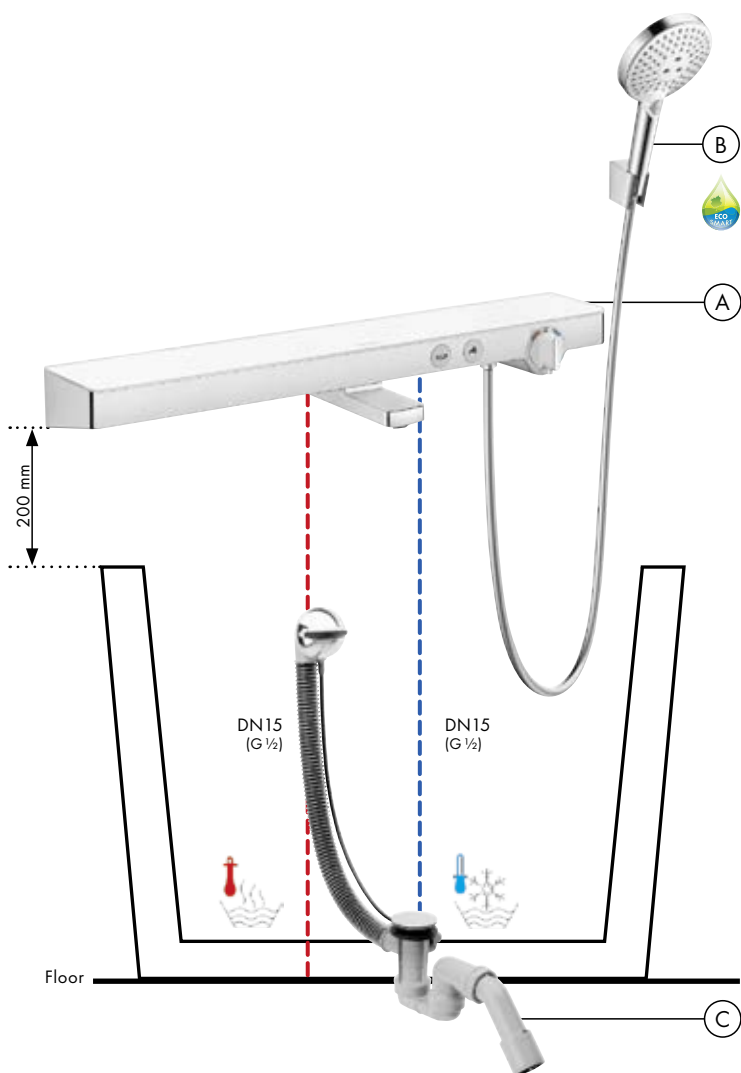

**Flow diagram**

Hand shower Raindance Select S 120 3jet  
# 26530, -400

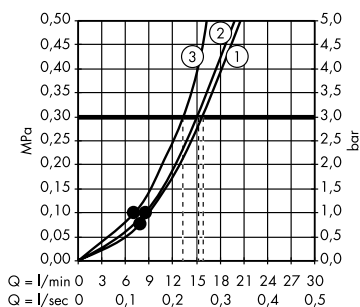

**Legend**

- ① RainAir
- ② Rain
- ③ Whirl

• denotes minimum operating pressure

Hansgrohe hand showers

# The hand shower range at a glance

Functionality ↑

**Crometta® 85**

**Crometta® 100**

**Croma® 100**

**Croma® Select**



More details on Crometta 85 hand showers can be found on page 52 onwards.



More details on Crometta 100 hand showers can be found on page 50 onwards.



More details on Croma hand showers can be found on page 48 onwards.



More details on Croma Select hand showers can be found on page 42 onwards.

**How to use the overview with your customer:**

The higher a shower is positioned on the product line, the greater its functionality. All EcoSmart versions can be found on the following pages for the range.

## Raindance®

## Raindance® Select



**Raindance® E**  
150 Air 3jet



**Raindance® S**  
150 Air 3jet



**Raindance® E**  
120 Air 3jet



**Raindance® S**  
120 Air 3jet



**Raindance® E**  
100 Air 3jet

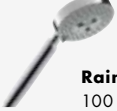

**Raindance® S**  
100 Air 3jet



**Raindance® Select E**  
150 3jet



**Raindance® Select S**  
150 3jet



**Raindance® Select E**  
120 3jet



**Raindance® Select S**  
120 3jet

More details on Raindance hand showers can be found on page 45 onwards.

More details on Raindance Select hand showers can be found on page 40 onwards.



Raindance® Select hand shower



# The right water spray for each shower type



(1) **RainAir:** a gentle, caressing spray.  
 (2) **Rain:** a powerful, revitalising spray.



**Whirl:** A concentrated massaging whirl to ease tension.



**Test rating very good:** 99% of users are happy with the showering feeling of the hand shower, and just as many praised the innovative Select button.\*

## Advantages and benefits

- Easy and convenient to change spray type at the push of a button
- For all showering needs: whether you want to start the day refreshed, easily rinse out shampoo, or simply relax
- Two full rain spray types in the one shower: a powerfully revitalising and a gently soothing spray
- For all tastes: available as a round version or with soft corners available in chrome or white/chrome

Find out more at <http://pro.hansgrohe-int.com/select>

## Raindance® Select



**Raindance® Select E 150 3jet**  
Hand shower  
# 26550, -000, -400 (16 l/min)  
# 26551, -000, -400 (9 l/min) EcoSmart

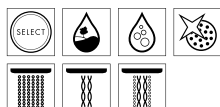

**Raindance® Select E 120 3jet**  
Hand shower  
# 26520, -000, -400 (16 l/min)  
# 26521, -000, -400 (9 l/min) EcoSmart

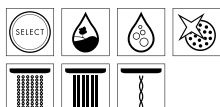

**Raindance® Select S 150 3jet**  
Hand shower  
# 28587, -000, -400 (16 l/min)  
# 28588, -000, -400 (9 l/min) EcoSmart

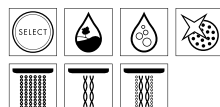

**Raindance® Select S 120 3jet**  
Hand shower  
# 26530, -000, -400 (16 l/min)  
# 26531, -000, -400 (9 l/min) EcoSmart

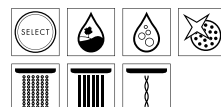

96% of users like the design and the white/chrome combination\*



**Raindance® Select E 150 3jet/Unica® 'S Puro Set**  
# 27857, -000, -400 0.90 m  
# 27856, -000, -400 0.65 m (not shown)

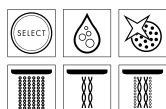

**Raindance® Select E 120 3jet/Unica® 'S Puro Set**  
# 26621, -000, -400 0.90 m  
# 26623, -000, -400 0.90 m EcoSmart  
# 26620, -000, -400 0.65 m (not shown)  
# 26622, -000, -400 0.65 m EcoSmart (not shown)

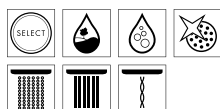

**Raindance® Select S 150 3jet/Unica® 'S Puro Set**  
# 27803, -000, -400 0.90 m  
# 27802, -000, -400 0.65 m (not shown)

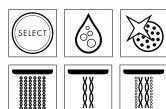

**Raindance® Select S 120 3jet/Unica® 'S Puro Set**  
# 26631, -000, -400 0.90 m  
# 26633, -000, -400 0.90 m EcoSmart  
# 26630, -000, -400 0.65 m (not shown)  
# 26632, -000, -400 0.65 m EcoSmart (not shown)

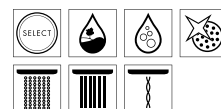

## Porter Sets

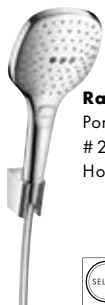

**NEW**

**Raindance® Select E 120 Porter Set**  
# 26720, -000, -400  
Hose length 1.60 m

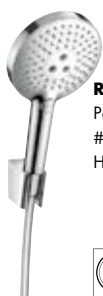
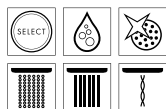

**NEW**

**Raindance® Select S 120 Porter Set**  
# 26721, -000, -400  
Hose length 1.60 m

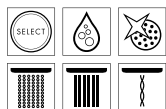

\*trnd consumer test Raindance® Select E 120 10/2013 with 500 participants in D, CH, AT.

All specified flow rates are based on an operating pressure of 0.3 MPa (3 bar).

Croma® Select hand shower

**NEW**



# More comfort for everyone

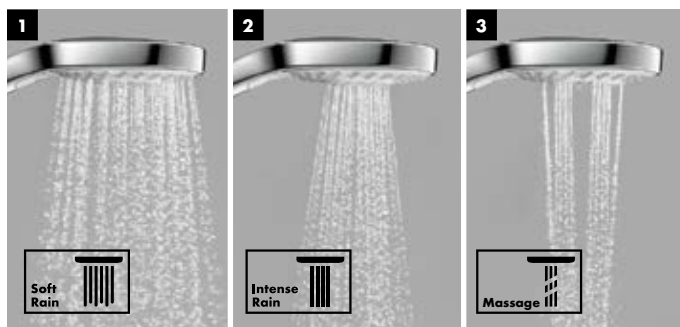
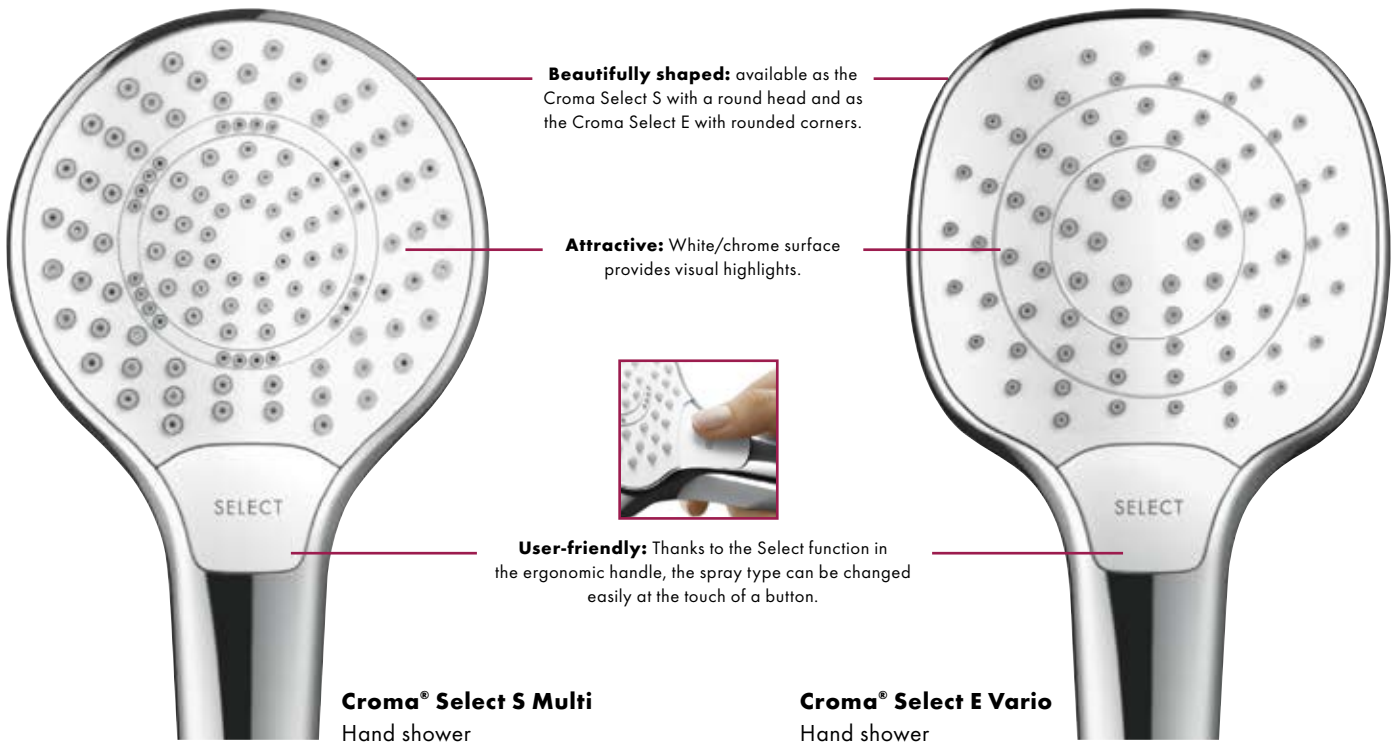

- (1) **SoftRain:** soft, beneficial water spray.
- (2) **IntenseRain:** intensive water spray that activates and refreshes.
- (3) **Massage:** concentrated, revitalising spray.

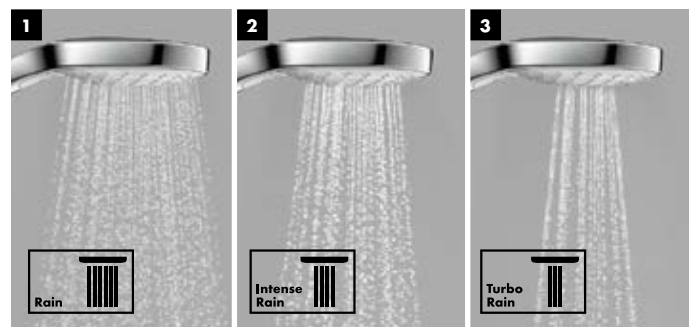

- (1) **Rain:** perfect for rinsing shampoo out of your hair.
- (2) **IntenseRain:** intensive water spray that activates and refreshes.
- (3) **TurboRain:** the most powerful of all Rain sprays - for a refreshingly powerful showering experience



## Advantages and benefits

- Easy spray change at the touch of a button thanks to Select technology - now also in the Croma range
- 110 mm spray face with new spray types for any shower requirement: whether just rinsing out shampoo, winding down in the evening or being full of energy in the morning
- **Easy to clean:** thanks to QuickClean
- Also available in the water-saving EcoSmart version at just 7 l/min

Find out more at <http://pro.hansgrohe-int.com/select>

**Croma® Select**

**NEW**



**Croma® Select E Multi** Hand shower  
 # 26810, -400 (16 l/min)  
 # 26811, -400 (9 l/min) EcoSmart



**Croma® Select E Vario** Hand shower  
 # 26812, -400 (15 l/min)  
 # 26813, -400 (9 l/min) EcoSmart



**Croma® Select E 1jet** Hand shower  
 # 26814, -400 (16 l/min)  
 # 26815, -400 (9 l/min) EcoSmart  
 # 26816, -400 (7 l/min) EcoSmart

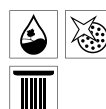
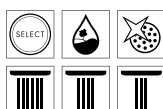
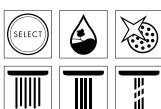

**Croma® Select S Multi** Hand shower  
 # 26800, -400 (16 l/min)  
 # 26801, -400 (9 l/min) EcoSmart



**Croma® Select S Vario** Hand shower  
 # 26802, -400 (15 l/min)  
 # 26803, -400 (9 l/min) EcoSmart



**Croma® Select S 1jet** Hand shower  
 # 26804, -400 (16 l/min)  
 # 26805, -400 (9 l/min) EcoSmart  
 # 26806, -400 (7 l/min) EcoSmart

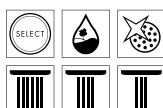
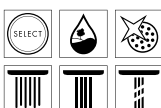

**Shower sets**



**Croma® Select E Multi** Shower Set  
 # 26580, -400 0.65 m  
 # 26581, -400 0.65 m EcoSmart  
 # 26590, -400 0.90 m (not shown)  
 # 26591, -400 0.90 m EcoSmart (not shown)

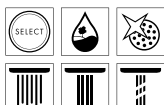

**Croma® Select E Vario** Shower Set  
 # 26582, -400 0.65 m  
 # 26583, -400 0.65 m EcoSmart  
 # 26586, -400 0.65 m with Casetta soap dish (not shown)  
 # 26592, -400 0.90 m (not shown)  
 # 26593, -400 0.90 m EcoSmart (not shown)

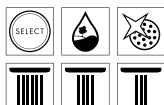

**Croma® Select E 1jet** Shower Set  
 # 26584, -400 0.65 m  
 # 26585, -400 0.65 m EcoSmart  
 # 26594, -400 0.90 m (not shown)  
 # 26595, -400 0.90 m EcoSmart (not shown)



### Shower sets



**Croma® Select S Multi** Shower Set  
 # 26560, -400 0.65 m  
 # 26561, -400 0.65 m EcoSmart  
 # 26570, -400 0.90 m (not shown)  
 # 26571, -400 0.90 m EcoSmart (not shown)

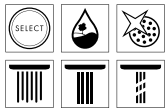

**Croma® Select S Vario** Shower Set  
 # 26562, -400 0.65 m  
 # 26563, -400 0.65 m EcoSmart  
 # 26566, -400 0.65 m with Casetta soap dish (not shown)  
 # 26572, -400 0.90 m (not shown)  
 # 26573, -400 0.90 m EcoSmart (not shown)

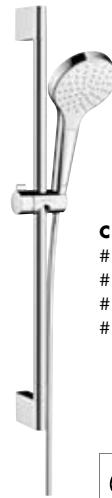
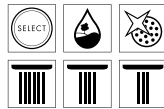

**Croma® Select S 1jet** Shower Set  
 # 26564, -400 0.65 m  
 # 26565, -400 0.65 m EcoSmart  
 # 26574, -400 0.90 m (not shown)  
 # 26575, -400 0.90 m EcoSmart (not shown)



### Porter Sets



**Croma® Select E Vario**  
 Porter Set  
 # 26425, -400 Hose length 1.25 m  
 # 26413, -400 Hose length 1.60 m

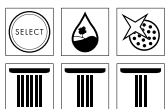

**Croma® Select E 1jet**  
 Porter Set  
 # 26424, -400 Hose length 1.25 m  
 # 26412, -400 Hose length 1.60 m

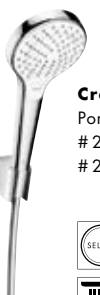
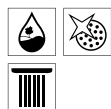

**Croma® Select S Vario**  
 Porter Set  
 # 26421, -400 Hose length 1.25 m  
 # 26411, -400 Hose length 1.60 m



**Croma® Select S 1jet**  
 Porter Set  
 # 26420, -400 Hose length 1.25 m  
 # 26410, -400 Hose length 1.60 m



All specified flow rates are based on an operating pressure of 0.3 MPa (3 bar).

## Raindance®



**Raindance® E 150 Air 3jet Hand shower**  
# 28518, -000 (18 l/min)  
# 28551, -000 (9 l/min) EcoSmart



**Raindance® E 120 Air 3jet Hand shower**  
# 28507, -000 (18 l/min)  
# 28549, -000 (9 l/min) EcoSmart



**Raindance® E 100 Air 3jet Hand shower**  
# 28502, -000 (15 l/min)  
# 28553, -000 (9 l/min) EcoSmart  
**Raindance® E 100 Air 1jet Hand shower**  
# 28508, -000 (18 l/min) (not shown)

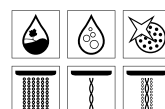
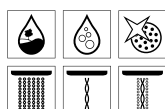
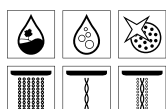

- Ergonomic short handle
- Elegant design

- Diameters up to 150 mm
- AirPower

- Three spray modes: RainAir, WhirlAir and BalanceAir



**Raindance® S 150 Air 3jet Hand shower**  
# 28519, -000 (18 l/min)  
# 28550, -000 (9 l/min) EcoSmart  
**Raindance® S 150 Air 1jet Hand shower**  
# 28505, -000 (17 l/min) (not shown)



**Raindance® S 120 Air 3jet Hand shower**  
# 28514, -000 (18 l/min)  
# 28554, -000 (9 l/min) EcoSmart



**Raindance® S 100 Air 3jet Hand shower**  
# 28504, -000 (15 l/min)  
# 28552, -000 (9 l/min) EcoSmart  
**Raindance® S 100 Air 1jet Hand shower**  
# 28509, -000 (18 l/min) (not shown)

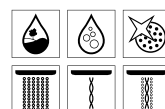
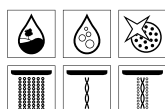
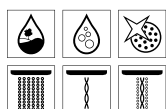

- Stylish, simple design language
- Ideal for minimalistic bathrooms

- Diameters up to 150 mm
- AirPower

- Three spray modes: RainAir, WhirlAir and BalanceAir

## Porter Set



**Raindance® S 100 Air 1jet/Porter 'S Set**  
# 27580, -000 Hose length 1.25 m  
# 27581, -000 Hose length 1.60 m

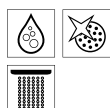

**Shower sets**



**Raindance® E 150 Air 3jet/  
Unica® Set**  
# 27874, -000 0.90 m  
# 27657, -000 0.90 m EcoSmart  
# 27888, -000 1.50 m  
(not shown)

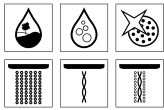

**Raindance® E 150 Air 3jet/  
Unica® 'D' Set**  
# 27894, -000 0.90 m  
# 27897, -000 0.65 m  
(not shown)

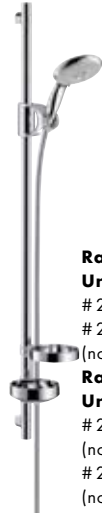
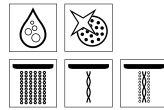

**Raindance® E 100 Air 3jet/  
Unica® 'D' Set**  
# 27881, -000 0.90 m  
# 27883, -000 0.65 m  
(not shown)  
**Raindance® E 120 Air 3jet/  
Unica® 'D' Set**  
# 27885, -000 0.90 m  
(not shown)  
# 27887, -000 0.65 m  
(not shown)

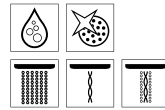

**Raindance® S 150 Air 3jet/  
Unica® Set**  
# 27893, -000 0.90 m  
# 27658, -000 0.90 m EcoSmart

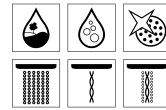

**Raindance® S 150 Air 3jet/  
Unica® 'S Puro' Set**  
# 27895, -000 0.90 m  
# 27898, -000 0.65 m  
(not shown)

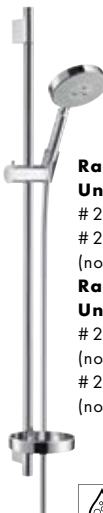
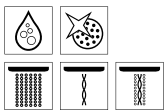

**Raindance® S 120 Air 3jet/  
Unica® 'S Puro' Set**  
# 27884, -000 0.90 m  
# 27886, -000 0.65 m  
(not shown)  
**Raindance® S 100 Air 3jet/  
Unica® 'S Puro' Set**  
# 27880, -000 0.90 m  
(not shown)  
# 27882, -000 0.65 m  
(not shown)

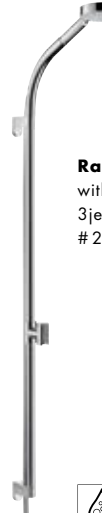
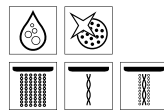

**Raindance® Rainbow® Set  
with Raindance® S 150 Air  
3jet**  
# 27876, -000 0.90 m

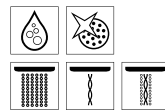

**Raindance® Allrounder Set  
with Raindance® E 150 Air 3jet**  
# 28110, -000  
# 28108, -000 Adapter for  
concealed installations  
(not shown)

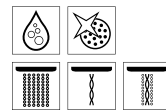

- Additional slider for height adjustments
- Use as both hand and overhead shower
- Flexible installations possible
- Large projection
- Long lasting metal construction

- Use as both hand and overhead shower
- Flexible installations possible
- Large projection
- Long lasting metal construction

## Raindance® Classic



**Raindance® Classic 100**  
Air 3jet Hand shower  
# 28548, -000 (17 l/min)

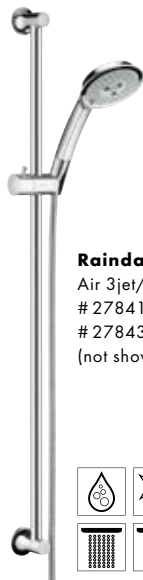
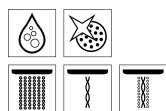

**Raindance® Classic 100**  
Air 3jet/**Unica® Classic Set**  
# 27841, -000 0.90 m  
# 27843, -000 0.65 m  
(not shown)

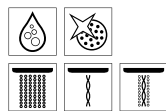

## PuraVida®



**DESIGN PLUS**  
powered by **ISH**

**PuraVida® 150 3jet**  
Hand shower  
# 28557, -000, -400 (16 l/min)  
# 28567, -000, -400 (9 l/min)  
EcoSmart

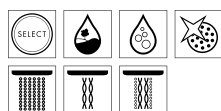

**PuraVida® 120 1jet**  
Baton hand shower  
# 28558, -000, -400 (16 l/min)  
# 28568, -000, -400 (9 l/min)  
EcoSmart

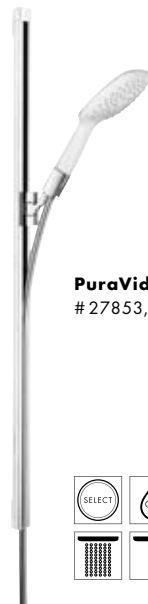
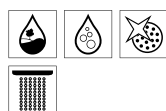

**PuraVida®/Unica® Set**  
# 27853, -000, -400 0.90 m

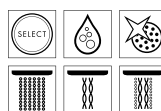

## Children's hand shower



**Joco®**  
Hand shower  
# 28560, -000 (9 l/min)

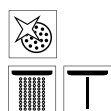



## Croma® 100



**Croma® 100 Multi**  
Hand shower  
# 28536, -000 (19 l/min)  
# 28538, -000 (9 l/min) EcoSmart  
# 26830, -000 (6 l/min) EcoSmart



**Croma® 100 Vario**  
Hand shower  
# 28535, -000 (18 l/min)  
# 28537, -000 (9 l/min) EcoSmart



**Croma® 100 1jet**  
Hand shower  
# 28580, -000 (16 l/min)  
# 28583, -000 (9 l/min) EcoSmart

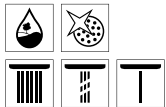

- Large spray face for great shower pleasure
- Three spray modes: Rain, Mono, Massage spray

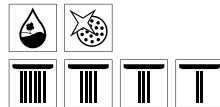

- Large spray face for great shower pleasure
- Four graduated rain sprays from wide to concentrated

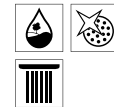

- Large spray face for great shower pleasure

## Porter Sets



**Croma® 100 Multi/Porter 'S Set**  
# 27593, -000 Hose length 1.25 m  
# 27595, -000 Hose length 1.60 m



**Croma® 100 Vario/Porter 'S Set**  
# 27592, -000 Hose length 1.25 m  
# 27594, -000 Hose length 1.60 m

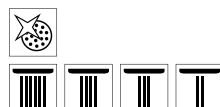

**Croma® 100 1jet/Porter 'S Set**  
# 27574, -000 Hose length 1.25 m  
# 27575, -000 Hose length 1.60 m



## Shower sets



**Croma® 100 Multi/  
Unica® 'C Set**  
# 27774, -000 0.90 m  
# 27655, -000 0.90 m  
EcoSmart  
# 27775, -000 0.65 m  
(not shown)  
# 27777, -000 0.65 m  
EcoSmart (not shown)

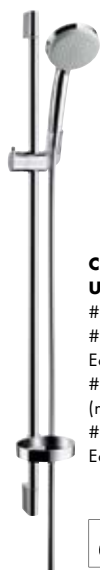

**Croma® 100 Vario/  
Unica® 'C Set**  
# 27771, -000 0.90 m  
# 27653, -000 0.90 m  
EcoSmart  
# 27772, -000 0.65 m  
(not shown)  
# 27776, -000 0.65 m  
EcoSmart (not shown)

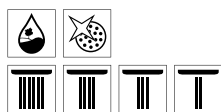

**Croma® 100 1jet/  
Unica® 'C Set**  
# 27724, -000 0.90 m  
# 27717, -000 0.65 m  
(not shown)



**Croma® 100 Multi/  
Unica® 'Reno Lift Set**  
# 27791, -000 1.05 m  
**Croma® 100 Vario/  
Unica® 'Reno Lift Set**  
# 27811, -000 1.05 m  
(not shown)

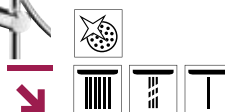

- Swivelling shower bar
- Drilled hole can be covered, so ideal for renovations

## Croma® 100 Classic



**Croma® 100 Classic Multi**  
Hand shower  
# 28539, -000 (19 l/min)



Crometta® 100 hand shower

**NEW**

# Genuine design at an irresistible price

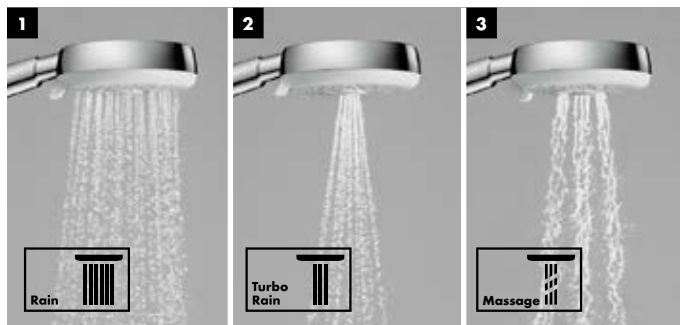
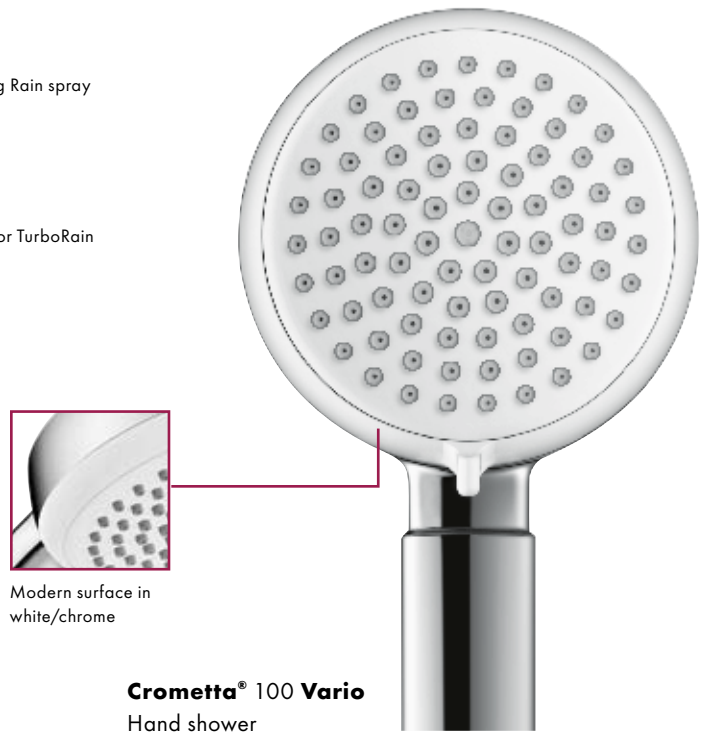
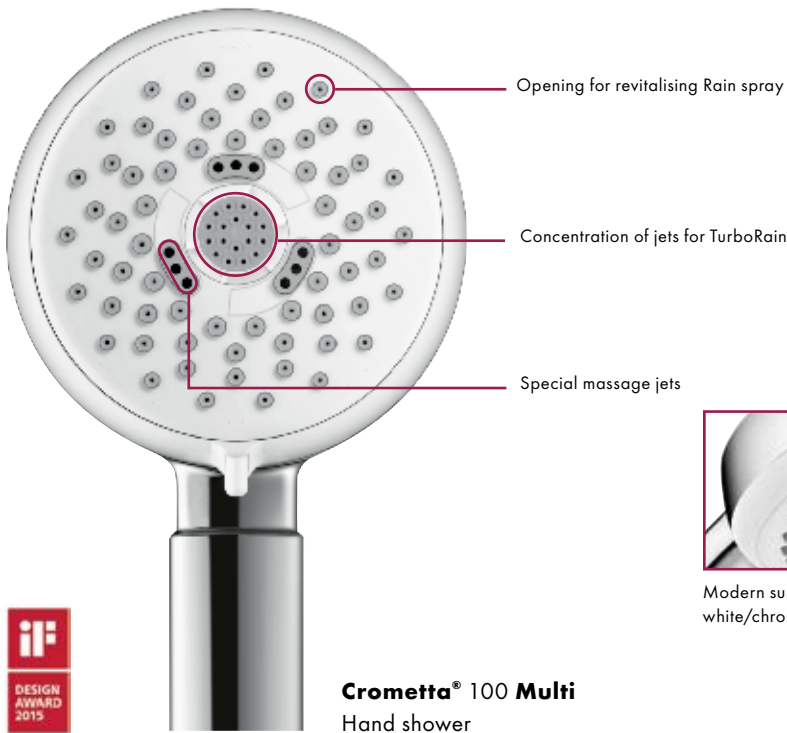

- (1) **Rain:** revitalising shower rain.
- (2) **TurboRain:** the most powerful of all Rain sprays – for a refreshingly powerful showering experience.
- (3) **Massage:** powerful, pulsating spray.

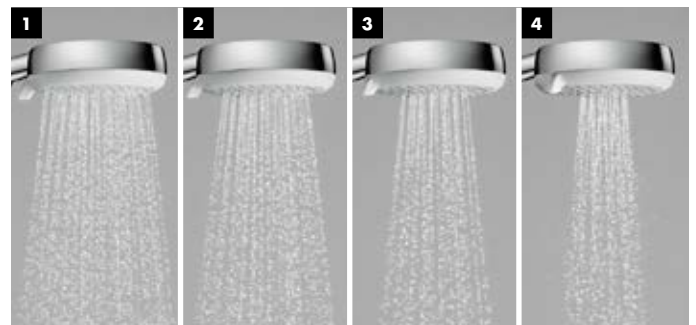

- (1-4) **Rain variants:** revitalising spray rain in 4 levels from wide to concentrated.



## Advantages and benefits

- XXL showering pleasure thanks to the 100 mm spray face
- Excellent value thanks to the popular Croma 100 mechanism and popular spray technology at the best price
- Many different spray types for any showering type – from wide to concentrated
- Ergonomic handle design for safe use
- **Easy to clean:** thanks to QuickClean
- Also available in the water-saving EcoSmart version at just 7 l/min

## Crometta® 100



**Crometta® 100 Multi**  
Hand shower  
# 26823, -400 (19 l/min)  
# 26826, -400 (9 l/min) EcoSmart



**Crometta® 100 Vario**  
Hand shower  
# 26824, -400 (18 l/min)  
# 26827, -400 (9 l/min) EcoSmart



**Crometta® 100 1jet**  
Hand shower  
# 26825, -400 (16 l/min)  
# 26828, -400 (9 l/min) EcoSmart  
# 26829, -400 (7 l/min) EcoSmart



## Porter Sets



**Crometta® 100 Vario**  
Porter Set  
# 26666, -400 Hose length 1.25 m  
# 26667, -400 Hose length 1.60 m



**Crometta® 100 1jet**  
Porter Set  
# 26664, -400 Hose length 1.25 m  
# 26665, -400 Hose length 1.60 m

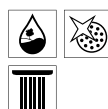

## Shower sets



**Crometta® 100 Multi**  
Shower Set  
# 26656, -400 0.90 m  
# 26659, -400 0.90 m EcoSmart  
# 26650, -400 0.65 m (not shown)  
# 26653, -400 0.65 m EcoSmart  
(not shown)



**Crometta® 100 Vario**  
Shower Set  
# 26657, -400 0.90 m  
# 26662, -400 0.90 m EcoSmart  
# 26651, -400 0.65 m (not shown)  
# 26654, -400 0.65 m EcoSmart  
(not shown)

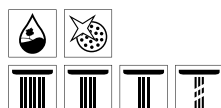

**Crometta® 100 1jet**  
Shower Set  
# 26658, -400 0.90 m  
# 26663, -400 0.90 m EcoSmart  
# 26652, -400 0.65 m (not shown)  
# 26655, -400 0.65 m EcoSmart  
(not shown)



All specified flow rates are based on an operating pressure of 0.3 MPa (3 bar).

## Crometta® 85



**Crometta® 85 Multi**  
Hand shower  
# 28563, -000 (16 l/min)  
# 28608, -000 (9 l/min)  
EcoSmart

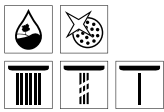

**Crometta® 85 Vario**  
Hand shower  
# 28562, -000 (17 l/min)  
# 28607, -000 (9 l/min)  
EcoSmart  
# 26831, -000 (6 l/min)  
EcoSmart

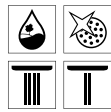

**Crometta® 85 1jet**  
Hand shower  
# 28585, -000 (16 l/min)  
# 28606, -000 (9 l/min)  
EcoSmart

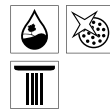

**Crometta® 85 Green**  
Hand shower  
# 28561, -000 (6 l/min)

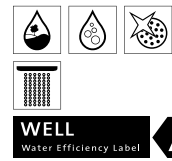

- Great value, suitable for many combinations
- Many spray types
- Also ideal as a shower for the bathtub

## Porter Sets



**Crometta® 85 Multi/  
Porter 'C Set**  
# 27568, -000  
Hose length 1.25 m  
# 27569, -000  
Hose length 1.60 m

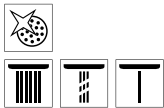

**Crometta® 85 Vario/  
Porter 'C Set**  
# 27558, -000  
Hose length 1.25 m  
# 27559, -000  
Hose length 1.60 m

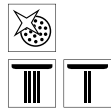

**Crometta® 85 1jet/  
Porter 'C Set**  
# 27576, -000  
Hose length 1.25 m  
# 27577, -000  
Hose length 1.60 m



## Shower sets

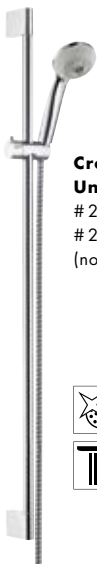

**Crometta® 85 Multi/  
Unica 'Crometta® Set**  
# 27766, -000 0.90 m  
# 27767, -000 0.65 m  
(not shown)

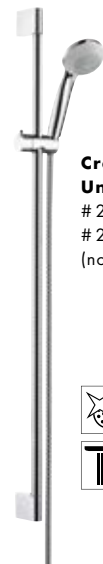
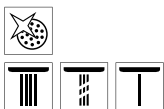



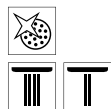





**Crometta® 85 Vario/  
Unica 'Crometta® Set**  
# 27762, -000 0.90 m  
# 27763, -000 0.65 m  
(not shown)



**Crometta® 85 1jet/  
Unica 'Crometta® Set**  
# 27729, -000 0.90 m  
# 27728, -000 0.65 m (not shown)  
**Crometta® 85 Green/  
Unica 'Crometta® Set**  
# 27651, -000 0.90 m (not shown)  
# 27652, -000 0.65 m (not shown)





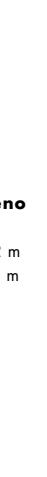

## Shower bars

 <p><b>PuraVida® Unica®</b> Shower bar with Isiflex shower hose 1.60 m # 27844, -000 0.90 m</p>	 <p><b>Raindance® Unica®</b> Shower bar with Isiflex shower hose 1.60 m # 27636, -000 0.90 m</p>	 <p><b>Unica® 'S Puro</b> Shower bar with Isiflex shower hose 1.60 m # 28632, -000 0.65 m # 28631, -000 0.90 m (not shown)</p>	 <p><b>Unica® 'Classic</b> Shower bar with Sensoflex shower hose 1.60 m # 27617, -000 0.65 m</p>	 <p><b>Unica® 'D</b> Shower bar with Isiflex shower hose 1.60 m # 27933, -000 0.65 m # 27930, -000 0.90 m (not shown)</p>
 <p><b>Unica® 'C</b> Shower bar with Isiflex shower hose 1.60 m # 27611, -000 0.65 m # 27610, -000 0.90 m (not shown)</p>	 <p><b>NEW</b> <b>Unica® 'Croma®</b> Shower bar with Isiflex shower hose 1.60 m # 26503, -000 0.65 m # 26504, -000 0.90 m (not shown) Alternatively without flexible hose # 26506, -000 0.90 m (not shown) # 26505, -000 0.65 m (not shown)</p>	 <p><b>Unica® 'Crometta®</b> Shower bar with Metaflex shower hose 1.60 m # 27615, -000 0.65 m # 27614, -000 0.90 m (not shown) Alternatively without flexible hose # 27609, -000 0.90 m (not shown)</p>	 <p><b>Unica® 'S Puro Reno</b> Shower bar # 28662, -000 0.72 m # 28663, -000 1.05 m (not shown)</p>	 <p><b>Unica® 'Reno</b> Shower bar # 27704, -000 0.72 m</p>

- Adjustable shower heights and angles
- Hands-free showering
- Flexible installations in shower cubicles and baths
- Shower can be swivelled out

## Shower hoses

 <p><b>Sensoflex®</b> Shower hose metal with plastic lining and swivel # 28132, -000 1.25 m # 28136, -000 1.60 m # 28134, -000 2.00 m</p>	 <p><b>Isiflex®</b> Shower hose of metal-look plastic # 28272, -000, -450 1.25 m # 28276, -000, -450 1.60 m # 28274, -000 2.00 m</p>	 <p><b>Isiflex® EcoSmart</b> metal-look shower hose with integrated flow rate limiter (9 l/min) # 28270, -000 1.25 m # 28271, -000 1.60 m # 28188, -000 2.00 m</p>	 <p><b>Metaflex®</b> Shower hose of metal-spiral-look plastic # 28262, -000 1.25 m # 28266, -000 1.60 m # 28264, -000 2.00 m</p>	 <p><b>Metaflex® EcoSmart</b> shower hose of metal-spiral-look plastic with integrated flow rate limiter (9 l/min) # 28198, -002 1.25 m # 28195, -002 1.50 m # 28199, -002 1.60 m # 28196, -002 1.75 m # 28197, -002 2.00 m</p>
---	---	---	--	--

- Various materials, lengths and looks
- Anti-kink and easy care
- Chrome effect matching the mixers
- Scratch free thanks to plastic coating
- Swivel for twist-free flexibility
- Particularly strong – confirmed by tension tests

## Shower holder



**Porter 'S**  
Shower holder  
# 28331, -000



**Porter 'C**  
Shower holder  
# 27521, -000



**Porter 'D**  
Variable shower holder  
Adjustable angle  
# 27526, -000



**Porter 'Classic**  
Shower holder  
# 28324, -000



**Porter 'A**  
Variable shower holder  
Metal housing  
Adjustable angle  
# 27520, -000

## Hose connections



**Fixfit\* E**  
Hose connection without non-return valve  
# 27454, -000  
Hose connection with non-return valve  
# 27458, -000  
Hose connection with non-return valve and pivot joint  
# 27505, -000 (not shown)



**Fixfit\* E**  
Hose connection with non-return valve and plastic angle  
# 26457, -000  
Hose connection with non-return valve and pivot joint  
# 27414, -000 (not shown)



**Fixfit\* E Stop**  
Hose connection with shut-off valve and non-return valve  
# 27452, -000



**Fixfit\* S**  
Hose connection with non-return valve and plastic angle  
# 26453, -000  
Hose connection without non-return valve  
# 27453, -000  
Hose connection with non-return valve  
# 27456, -000  
Hose connection with non-return valve and pivot joint  
# 27506, -000 (not shown)



**Fixfit\* Square**  
Hose connection with non-return valve and plastic angle  
# 26455, -000



**Fixfit\* Classic**  
Hose connection with non-return valve  
# 16884, -000, -820

## Shower support with hose connection

**NEW**



### Fixfit® Porter 'S

Hose connection DN15 with integrated shower support  
Flexible hose and hand shower can be chosen freely  
# 26487, -000



### Fixfit® Porter 'E

Hose connection DN15 with integrated shower support  
Flexible hose and hand shower can be chosen freely  
# 26485, -000



### Fixfit® Porter 'Square

Hose connection DN15 with integrated shower support  
Flexible hose and hand shower can be chosen freely  
# 26486, -000



### Porter 'E

Variable shower holder  
Hose length 1.25 m  
Adjustable angle  
# 27507, -000



- Three different designs to suit any finish set and shower

- Permanently safe function thanks to the high-quality metal housing and internal plastic water channels

- Few drill holes, so installation is fast and easy
- Suits any DN15 flexible hose



- Integrated hose connection
- Isiflex shower hose 1.25 m

## Soap dishes



### Casetta® 'E

Soap dish  
# 26519, -000



### Casetta® 'C

Soap dish  
# 28678, -000



### Casetta® 'S Puro

Soap dish  
# 28679, -000



Hansgrohe overhead showers

# The overhead shower range at a glance

Functionality ↑

**Crometta®**

**Croma®/Croma® Select**

**Raindance®**



**Crometta® 160**

More details on Crometta overhead showers can be found on pages 66 onwards.



**Croma® 220 1jet**



**Croma® Select E 180 2jet**



**Croma® Select S 180 2jet**

More details on Croma and Croma Select overhead showers can be found on pages 62 onwards.



**Raindance® E 420 Air 2jet**  
**Raindance® E 420 Air 1jet**  
(not shown)



**Raindance® E 360 Air 1jet**  
**Raindance® E 240 Air 1jet**  
(not shown)



**Raindance® Royale S 350 Air 1jet**



**Raindance® S 300 Air 1jet**



**Raindance® 260 Air 1jet**



**Raindance® S 240 Air 1jet**

More details on Raindance E and Raindance S overhead showers can be found on pages 64 onwards.

**How to use the overview in your sales presentation.**

The higher an overhead shower is positioned on the product line, the greater its functionality. The products are arranged in ranges extending to the right.

### Raindance® Select

### Raindance® Rainmaker®/ Raindance® Rainfall®

### Rainmaker® Select



**Raindance® Select E**  
300 3jet



**Raindance® Select S**  
300 2jet



**Raindance® Select S**  
300 2jet  
**Raindance® Select S**  
240 2jet (not shown)

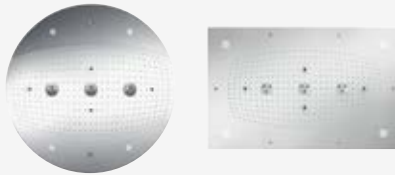

**Raindance® Rainmaker®**  
Air 3jet



**Raindance® Rainfall®**  
240 Air 3jet



**Raindance® Rainfall®**  
180 Air 2jet



**Raindance® Rainfall®**  
150 1jet



**Raindance® Rainfall® Stream**  
150 1jet

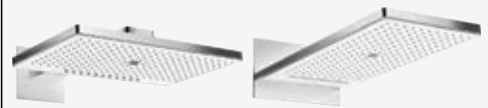

**Rainmaker® Select**  
460 3jet

**Rainmaker® Select**  
580 3jet



**Rainmaker® Select** 460 2jet  
**Rainmaker® Select** 460 1jet  
(not shown)

More details on Raindance Select overhead showers can be found on pages 60 onwards.

More details on Raindance Rainmaker and Raindance Rainfall overhead showers can be found on pages 68 onwards.

More details on Rainmaker Select overhead showers can be found on pages 58 onwards.

Rainmaker® Select 460 3jet overhead shower

**NEW**

# Tremendous pleasure across the whole width

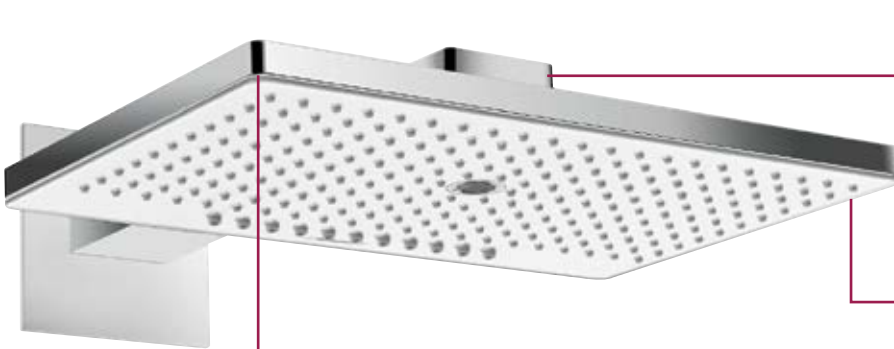

QuickConnect holder for easy attachment and quick removal for cleaning



A bathroom highlight thanks to high-quality materials such as chrome-plated metal and safety glass with lasered holes



Surface white/  
chrome

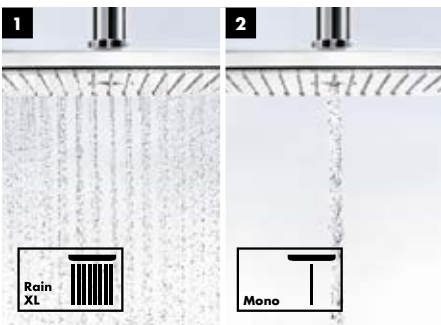

(1) **Rain XL:** full rain spray for tremendous showering pleasure.  
 (2) **Mono:** bundled spray for targeted showering pleasure.



**RainStream:** Eleven jets run parallel down to the floor for a generous shower.



**Flexible:** Also available for ceiling mounting, when it can be positioned freely anywhere in the room.



## Advantages and benefits

- Clear, precise design for the modern bathroom
- Spatial character meets the trend for larger showers
- **Easy to clean:** the glass panel is resistant to detergents, which makes it suitable for hotels as well
- The height of the wall mounted product can be varied for an optimum spray intensity.
- Also available in the EcoSmart version with only 9 l/min

# Rainmaker® Select

**NEW**



**Rainmaker® Select 580 3jet**  
 Overhead shower  
 Rain XL: 17 l/min  
 RainFlow: 17 l/min  
 Mono: 19 l/min  
 # 24001, -400  
 # 24011, -400 (9 l/min) EcoSmart  
 for iBox universal



Surface white/chrome



Black glass surface available on request

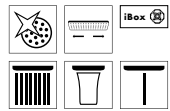

**Rainmaker® Select 460 3jet**  
 Overhead shower, with shower arm 460 mm  
 Rain XL: 18 l/min  
 RainStream: 16 l/min  
 Mono: 19 l/min  
 # 24007, -400  
 # 24017, -400 (9 l/min) EcoSmart  
 for iBox universal

**Rainmaker® Select 460 3jet**  
 Overhead shower, with ceiling connection 100 mm (not shown)  
 Rain XL: 20 l/min  
 RainStream: 17 l/min  
 Mono: 21 l/min  
 # 24006, -400  
 # 24016, -400 (9 l/min) EcoSmart



**Rainmaker® Select 460 2jet**  
 Overhead shower, with shower arm 460 mm  
 Rain XL: 18 l/min  
 RainStream: 16 l/min  
 # 24005, -400  
 # 24015, -400 (9 l/min) EcoSmart  
 for iBox universal

**Rainmaker® Select 460 2jet**  
 Overhead shower, with ceiling connection 100 mm (not shown)  
 Rain XL: 20 l/min  
 RainStream: 17 l/min  
 # 24004, -400  
 # 24014, -400 (9 l/min) EcoSmart



**Rainmaker® Select 460 1jet**  
 Overhead shower, with shower arm 460 mm  
 Rain XL: 18 l/min  
 # 24003, -400  
 # 24013, -400 (9 l/min) EcoSmart

**Rainmaker® Select 460 1jet**  
 Overhead shower, with ceiling connection 100 mm (not shown)  
 Rain XL: 19 l/min  
 # 24002, -400  
 # 24012, -400 (9 l/min) EcoSmart

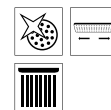
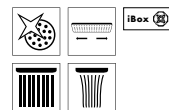
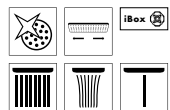

Raindance® Select E 300 3jet overhead shower



# 1 button, three sprays, great fun

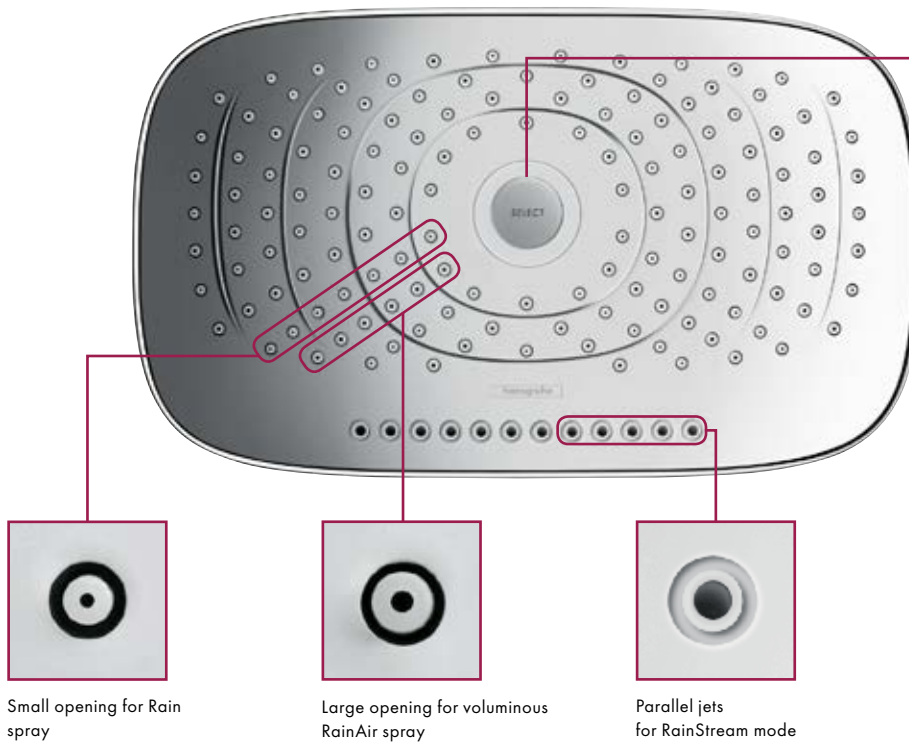

Easily accessible, the Select button need only be touched to change between RainAir and Rain



Small opening for Rain spray



Large opening for voluminous RainAir spray



Parallel jets for RainStream mode

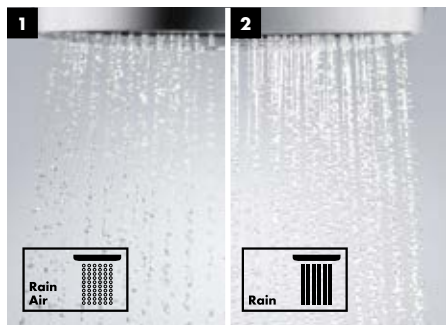

(1) **RainAir:** This gentle, relaxing spray consists of large, soft drops.  
 (2) **Rain:** A spray that is strong and revitalising and perfect for washing the hair.



**RainStream:** Twelve jets run parallel down to the floor for a generous shower.

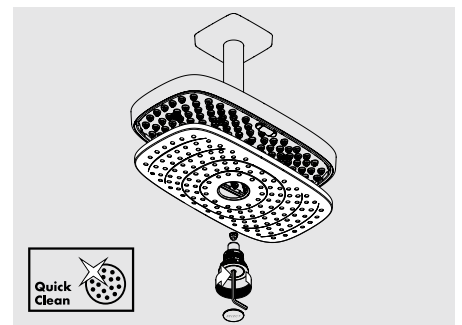

**Easy cleaning:** Jets can be cleaned effortlessly with the QuickClean function. Spray face can be taken off easily and is even dishwasher safe.



## Advantages and benefits

- 3 full spray types in the one overhead shower: gentle RainAir, powerful Rain and effective RainStream
- Simply switch between RainAir and Rain at the touch of a button
- Select button is easily accessible
- **Easy cleaning:** the metal spray face is dishwasher safe

Find out more at <http://pro.hansgrohe-int.com/select>

## Raindance® Select



**Raindance® Select E 300 3jet**  
 Overhead shower  
 # 26468, -000, -400  
 Rain/RainAir: 18 l/min  
 RainStream: 22 l/min  
 with shower arm 390 mm  
 for iBox universal



**Raindance® Select E 300 2jet**  
 Overhead shower  
 Rain/RainAir: 15 l/min  
 with shower arm 390 mm  
 # 27385, -000, -400  
 # 26609, -000, -400 (Rain/RainAir: 9 l/min) EcoSmart  
 with ceiling connection 100 mm (not shown)  
 # 27384, -000, -400  
 # 26608, -000, -400 (Rain/RainAir: 9 l/min) EcoSmart (not shown)

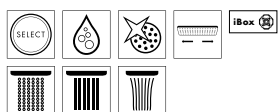

**Raindance® Select S 300 2jet**  
 Overhead shower  
 Rain/RainAir: 17 l/min  
 # 27378, -000, -400 with shower arm 390 mm  
 # 27337, -000, -400 with ceiling connection 100 mm (not shown)



**Raindance® Select S 240 2jet**  
 Overhead shower  
 Rain/RainAir: 17 l/min  
 with shower arm 390 mm  
 # 26466, -000, -400  
 # 26470, -000, -400 (Rain/RainAir: 9 l/min) EcoSmart  
 with ceiling connection 100 mm (not shown)  
 # 26467, -000, -400  
 # 26469, -000, -400 (Rain/RainAir: 9 l/min) EcoSmart (not shown)

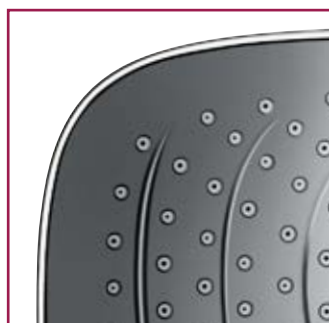
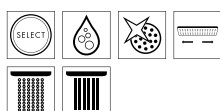

Surface chrome

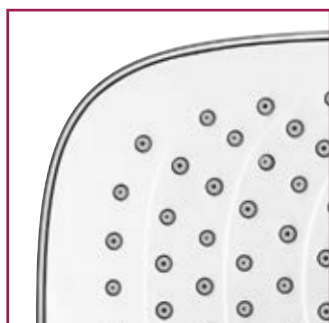

Surface white/chrome

Croma® Select overhead shower

**NEW**

# Comfort in top form

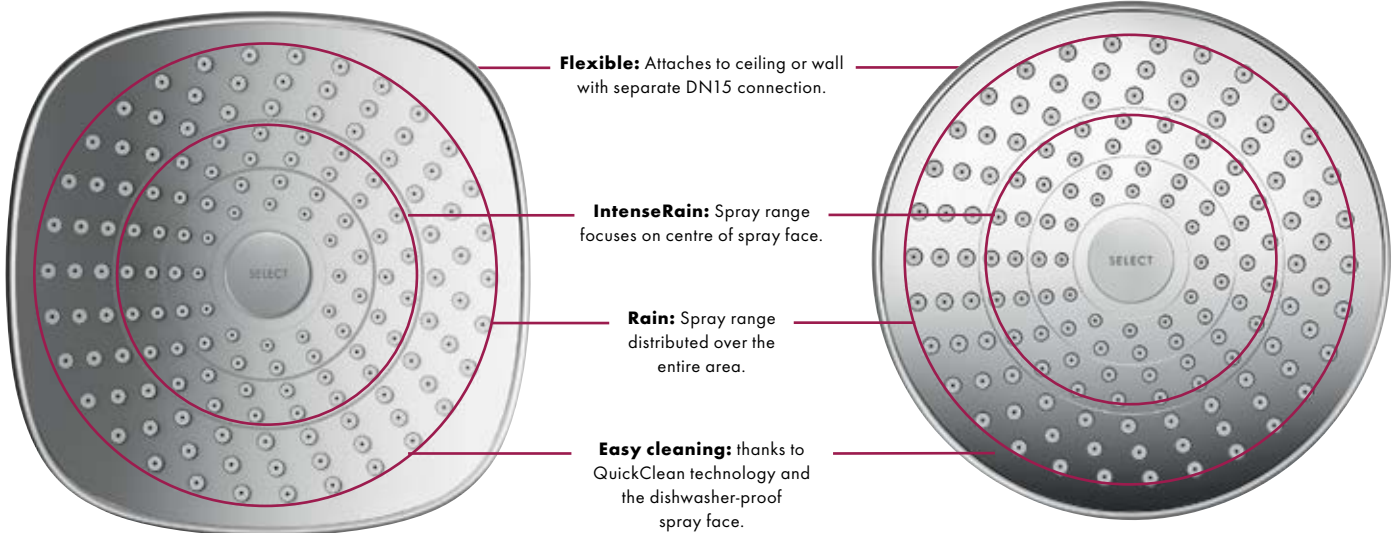
**Croma® Select E** 180 2jet**Croma® Select S** 180 2jet

**Rain:** flat rain from large, feel-good water drops.



**IntenseRain:** intensive water spray that activates and refreshes.



**User-friendly:** A simple touch of the Select button (from below) is all it takes to change the spray type.



## Advantages and benefits

- New design language with a large spray face of 180 mm diameter
- Available in two finishes: chrome and white/chrome
- Two different rain sprays: flat Rain spray, and refreshing, intensive IntenseRain
- Easy to change the spray types at the touch of a button
- Also available in the EcoSmart version with only 9 l/min

Find out more at <http://pro.hansgrohe-int.com/select>

## Croma® Select



**Croma® Select E** 180 2jet  
Overhead shower  
Rain/IntenseRain: 17 l/min  
# 26524, -000, -400  
# 26528, -000, -400 (9 l/min) EcoSmart



**Croma® Select E**  
Shower arm 390 mm  
# 27446, -000



**Croma® Select E**  
Ceiling connection  
# 27467, -000 100 mm  
# 27388, -000 300 mm (not shown)

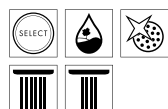

**Croma® Select S** 180 2jet  
Overhead shower  
Rain/IntenseRain: 17 l/min  
# 26522, -000, -400  
# 26523, -000, -400 (9 l/min) EcoSmart



**Croma® Select S**  
Shower arm 390 mm  
# 27413, -000



**Croma® Select S**  
Ceiling connection  
# 27393, -000 100 mm  
# 27389, -000 300 mm (not shown)

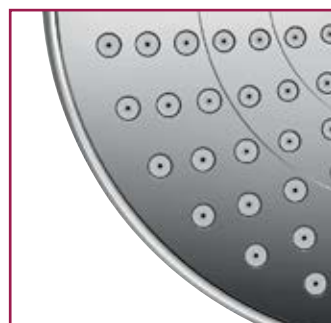
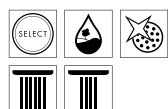

Surface chrome

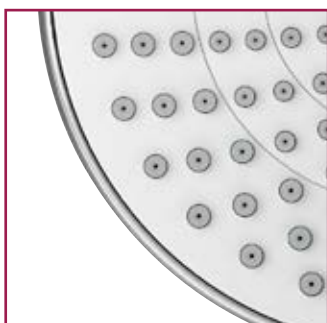

Surface white/chrome

All specified flow rates are based on an operating pressure of 0.3 MPa (3 bar).



## Raindance®



**Raindance® E 420 Air 2jet**  
Overhead shower  
# 27373, -000 with shower arm 380 mm  
RainAir: 22 l/min  
RainFlow: 23 l/min  
for iBox universal



**Raindance® E 420 Air 1jet**  
Overhead shower (19 l/min)  
# 27372, -000 with shower arm 380 mm

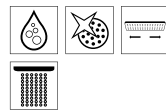

**Raindance® E 360 Air 1jet**  
Overhead shower (17 l/min)  
# 27376, -000 with shower arm 390 mm  
# 27371, -000 with shower arm 240 mm (not shown)  
# 27381, -000 with ceiling connection 100 mm (not shown)

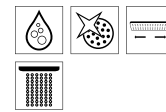

**Raindance® E 240 Air 1jet**  
Overhead shower (20 l/min)  
# 27370, -000 with shower arm 240 mm  
# 27380, -000 with ceiling connection 100 mm (not shown)  
# 27375, -000 with shower arm 223 mm (9 l/min)  
EcoSmart (not shown)  
# 27383, -000 with ceiling connection 100 mm (9 l/min) EcoSmart (not shown)





**Raindance® Royale S 350 Air 1jet**

Overhead shower (25 l/min)

# 28420, -000

# 27410, -000 Shower arm 470 mm (not shown)

# 27418, -000 Ceiling connection 100 mm (not shown)



**Raindance® S 300 Air 1jet**

Overhead shower (18 l/min)

# 27493, -000 with shower arm 390 mm

# 27492, -000 with shower arm 450 mm (not shown)

# 27494, -000 with ceiling connection 100 mm (not shown)

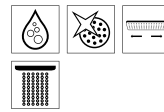
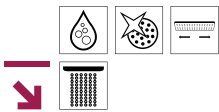

- Particularly large spray face of 350 mm diameter
- High flow rate for luxurious shower pleasure
- All-metal



**Raindance® S 240 Air 1jet**

Overhead shower (18 l/min)

# 27474, -000 with shower arm 390 mm

# 27461, -000 with shower arm 390 mm (9 l/min) EcoSmart

# 27477, -000 with ceiling connection 100 mm (not shown)

# 27463, -000 with ceiling connection 100 mm (9 l/min) EcoSmart (not shown)



**Raindance® S 180 Air 1jet**

Overhead shower (19 l/min)

# 27476, -000 with shower arm 240 mm

# 27462, -000 with shower arm 240 mm (9 l/min) EcoSmart

# 27468, -000 with shower arm 390 mm (not shown)

# 27478, -000 with ceiling connection 100 mm (not shown)

# 27464, -000 with ceiling connection 100 mm (9 l/min) EcoSmart (not shown)

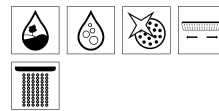

**Raindance® Classic**



**Raindance® Classic 240 Air**

Overhead shower (19 l/min)

# 27424, -000 with shower arm 390 mm

# 27405, -000 with ceiling connection 100 mm (not shown)

**PuraVida®**



**PuraVida® 400**

Overhead shower (21 l/min)

# 27437, -000, -400 with shower arm 390 mm

# 26602, -000, -400 (9 l/min) EcoSmart

# 27390, -000, -400 with ceiling connection 100 mm (not shown)

# 26603, -000, -400 (9 l/min) EcoSmart (not shown)

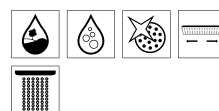
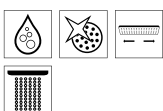

## Croma®



**Croma® 220 Air 1jet**  
Overhead shower  
# 26464, -000 (19 l/min)  
# 26465, -000 (9 l/min) EcoSmart  
# 27413, -000 Optional shower arm  
390 mm (not shown)  
# 27479, -000 Optional ceiling  
connection 100 mm (not shown)



**Croma® 160 1jet**  
Overhead shower  
# 27450, -000 (17 l/min)  
# 28450, -000 (9 l/min) EcoSmart  
# 27412, -000 Optional shower arm  
230 mm (not shown)  
# 27479, -000 Optional ceiling  
connection 100 mm (not shown)



**Croma® 100 Multi**  
Overhead shower  
# 27443, -000  
Rain: 20 l/min  
Mono: 15 l/min  
Massage: 14 l/min  
with ball joint DN15  
# 28460, -000 (9 l/min) EcoSmart  
# 27411, -000 Optional shower arm  
128 mm (not shown)



**Croma® 100 Vario**  
Overhead shower  
# 27441, -000  
Rain: 22 l/min  
Shampoo: 17 l/min  
Normal: 20 l/min  
Massage: 11 l/min  
# 28462, -000 (9 l/min) EcoSmart  
# 27411, -000 Optional shower arm  
128 mm (not shown)

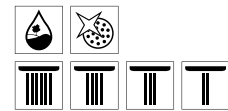
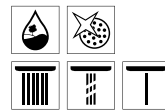
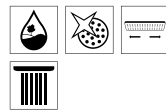
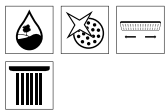

## Crometta® 160

**NEW**



**Crometta® 160**  
Overhead shower  
# 26577, -000, -400 (17 l/min)  
# 26578, -000, -400 (9 l/min) EcoSmart  
# 27412, -000 Optional shower arm 230 mm (not shown)  
# 27479, -000 Optional ceiling connection 100 mm  
(not shown)

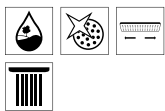

- Attractive price for large scale projects e.g. hotels
- Available in the water-saving EcoSmart version at just 9 l/min
- Also available in a LowPressure version (from 0.2 bar)
- Modern new design language with the surface in white/chrome
- Large spray face of 160 mm diameter



Surface chrome



Surface white/chrome



## Crometta® 85



### Crometta® 85 Multi

Overhead shower  
 # 28425, -000  
 Mono: 13 l/min  
 Normal: 15 l/min  
 Massage: 13 l/min  
 # 27411, -000 Optional shower arm  
 128 mm (not shown)



### Crometta® 85 Vario

Overhead shower  
 # 28424, -000  
 Normal: 18 l/min  
 # 27411, -000 Optional shower arm  
 128 mm (not shown)



### Crometta® 85 Green

Overhead shower  
 # 28423, -000 (6 l/min)  
 # 27411, -000 Optional shower arm  
 128 mm (not shown)

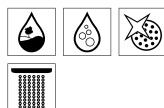
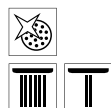
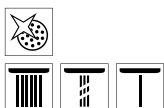

## Side showers



**PuraVida® 100**  
 Side shower  
 # 28430, -000, -400



**Raindance® Air 100**  
 Side shower  
 # 28477, -000



**Bodyvette®**  
 Side shower  
 # 28466, -000  
**Bodyvette® Stop**  
 Side shower, manual shut-off  
 # 28467, -000 (not shown)

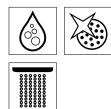
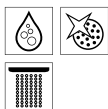

Raindance® Rainmaker® and Raindance® Rainfall®

# The ultimate enjoyment for your customers

The Raindance Rainmaker and the Raindance Rainfall turn everyday showering into a new experience. The Raindance Rainmaker is installed flush in the ceiling. The classic shower therefore no longer exists,

instead there is a room filled with wonderful rain. The spray modes are RainAir, RainAir XL, Whirl and Mix. With its horizontal rain panel, Raindance Rainfall allows greater freedom of movement and offers up to three different spray

types for pampered showering: relaxing RainAir, revitalising RainFlow and massaging Whirl.

## Raindance® Rainmaker®: Showering in a new dimension

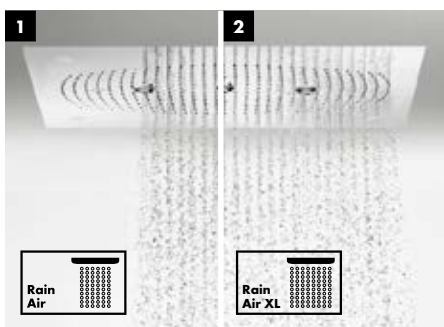

(1) **RainAir:** Central overhead shower function with AirPower technology.

(2) **RainAir XL:** Full, soft rain with AirPower technology.

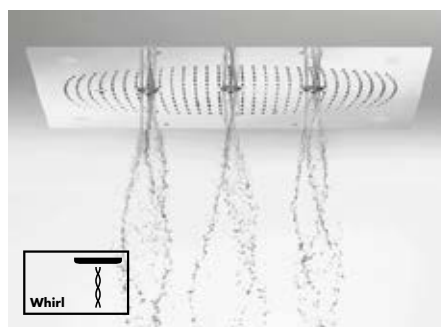

**Whirl:** Three rotating massage sprays with AirPower technology.



### Advantages and benefits

- Installed flush in the ceiling
- Full shower rain
- Also with integrated lighting

## Raindance® Rainfall® 240 Air 3jet: Water with its original power



**RainAir:** The overhead shower featuring AirPower technology generates a rain of voluminous drops.



**RainFlow:** A full flood jet for a refreshing shower.



**Whirl:** When water starts to flow, the massage sprays swivel forwards, easily reaching the neck and shoulders.



### Advantages and benefits

- Architectural highlight in the shower
- Greater coverage allows wider freedom of movement
- Three spray modes: RainAir, RainFlow and Whirl
- Spray modes can be changed conveniently from below
- Flood jet provides a shower feeling like being under a waterfall
- Flush installation on Basic iBox universal



**Raindance® Rainmaker® Air 3jet**  
Overhead shower  
600 mm  
RainAir: 20 l/min  
RainAir XL: 24 l/min  
Whirl: 22 l/min  
# 26117, -000 with light  
# 26115, -000 without light (not shown)

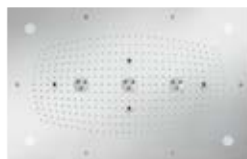

**Raindance® Rainmaker® Air 3jet**  
Overhead shower  
680 mm x 460 mm  
RainAir: 20 l/min  
RainAir XL: 24 l/min  
Whirl: 22 l/min  
# 28418, -000 with light  
# 28417, -000 without light (not shown)



**Raindance® 260 Air 1jet**  
Overhead shower  
260 mm x 260 mm, flush ceiling installation possible  
# 26472, -000 (17 l/min)  
# 26481, -000 (9 l/min) EcoSmart

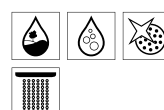
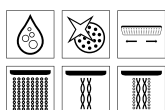
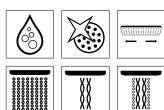

**Raindance® Rainfall® 240 Air 3jet**  
Overhead shower  
RainAir: 18 l/min  
Whirl: 16 l/min  
RainFlow: 28 l/min  
# 28410, -000, -400 with light (not shown)  
# 28411, -000, -400 without light  
for iBox universal



**Raindance® Rainfall® 180 Air 2jet**  
Overhead shower  
RainAir: 16 l/min  
RainFlow: 24 l/min  
# 28433, -000, -400  
for iBox universal

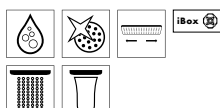

**Raindance® Rainfall® 150 1jet**  
Overhead shower (18 l/min)  
# 26442, -000



**Raindance® Rainfall® Stream 150 1jet**  
Overhead shower (18 l/min)  
# 26443, -000

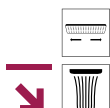

- Full flood jet
- For showering pleasure like being under a waterfall

- Parallel jets of sparkling water right down to the floor
- For showering pleasure like being under a waterfall



All specified flow rates are based on an operating pressure of 0.3 MPa (3 bar).

Raindance® Select E 300 3jet Showerpipe



# The complete system for all showering needs



**Select**  
Select the spray types

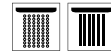

**RainStream:** Twelve jets of sparkling water that run parallel right down to the floor. For the same fascinating shower effects at every installation height and for every body size.



**Select**  
Select the spray types

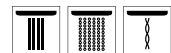

**Select**  
Select the hand shower

**Select**  
Select the overhead shower

**Select**  
Switch RainStream on and off on the overhead shower



Setting the temperature

**Raindance® Select E 300 3jet**  
Showerpipe





## Advantages and benefits

- Complete system with overhead shower, hand shower and thermostat
- Intuitive control concept, pleasure at the touch of a button
- Installation possible on existing connections, so ideal solution for bathroom refurbishments with minimal effort
- Six spray modes: three from the overhead shower, three from the hand shower
- Overhead shower including RainStream with twelve parallel jets

Find out more at <http://pro.hansgrohe-int.com/select>

Hansgrohe Showerpipes

## The Showerpipe range at a glance

	Crometta®	Croma®		Croma®
				
Product name	<b>Crometta® 160 1jet Showerpipe</b>	<b>Croma® 160 1jet Showerpipe</b>	<b>Croma® 220 1jet Showerpipe</b>	<b>Croma® Select S 180 2jet Showerpipe</b>
Versions	Shower with thermostat	# 27264, -400	# 27135, -000	# 27185, -000
	Shower with EcoSmart thermostat (9 l/min)	# 27265, -400	# 27238, -000	# 27188, -000
	Shower with single lever mixer	# 27266, -400	# 27154, -000	# 27222, -000
	Bath with thermostat	-	-	# 27223, -000
	Reno bath/shower	-	-	# 27224, -000
Overhead shower	Overhead shower	Crometta 160 1jet	Croma 160 1jet	Croma 220 1jet
	Size of overhead shower	Ø 160 mm	Ø 160 mm	Ø 220 mm
	Overhead shower spray types	Rain	Rain	RainAir
	Flow at 3 bar	18 l/min	17 l/min	19 l/min
	Select changeover of spray types	-	-	-
Features	Spray face removable for cleaning	-	-	■
	Swivel shower arm	-	-	■
	Length of shower arm	350 mm	270 mm	400 mm
	Hand shower	Crometta 100 Vario	Croma 100 Vario	Croma 100 Vario
	Shower hose	Isiflex 160 cm	Isiflex 160 cm	Isiflex 160 cm
Uniques	Thermostat	Ecostat Universal	Ecostat Comfort	Ecostat Comfort
	Riser pipe can be shortened	■	■	■
	Select	-	-	■
	AirPower	-	-	■
	QuickClean	■	■	■

■ Available. - Not available.



**a® Select**

**Raindance®**

**Raindance® Select S**



<b>Croma® Select E 180 2jet</b> Showerpipe	<b>Raindance® 240 Air 1jet</b> Showerpipe	<b>Raindance® Select S 240 1jet</b> Showerpipe	<b>Raindance® Select S 240 2jet</b> Showerpipe	<b>Raindance® Select S 300 1jet</b> Showerpipe
# 27256, -400	# 27145, -000	# 27115, -000	# 27129, -000, -400	# 27114, -000
# 27257, -400	-	# 27116, -000	-	-
# 27258, -400	-	-	-	-
# 27352, -400	-	# 27117, -000	-	-
-	-	-	-	-
Croma Select E 180 2jet	Raindance 240 Air 1jet	Raindance Select S 240 Air 1jet	Raindance Select S 240 2jet	Raindance Select S 300 Air 1jet
Ø 180 mm	Ø 240 mm	Ø 240 mm	Ø 240 mm	Ø 300 mm
Rain IntenseRain	RainAir	RainAir	RainAir Rain	RainAir
17 l/min	17 l/min	17 l/min	15 l/min	17 l/min
■	-	-	■	-
-	-	-	■	-
■	■	■	■	■
400 mm	460 mm	460 mm	460 mm	460 mm
Croma Select E Multi	Raindance S 100 Air 3jet	Raindance Select S 150	Raindance Select S 120 2jet	Raindance Select S 150 3jet
Isiflex 160 cm	Isiflex 160 cm	Isiflex 160 cm	Isiflex 160 cm	Isiflex 160 cm
EcoStat Comfort	EcoStat concealed	EcoStat Comfort	EcoStat Comfort	EcoStat Comfort
■	■	■	■	■
■	-	■	■	■
-	■	■	■	■
■	■	■	■	■

## Raindance® Select E



<b>Raindance® Select S 300 2jet</b> Showerpipe	<b>Raindance® Select E 360</b> Showerpipe	<b>Raindance® Select E 300 2jet</b> Showerpipe	<b>Raindance® Select E 360 ST</b> Showerpipe	<b>Raindance® Select E 300 2jet ST</b> Showerpipe
# 27133, -000, -400	# 27112, -000, -400	# 27128, -000, -400	# 27288, -000, -400	# 27126, -000, -400
-	# 27286, -000, -400	# 27282, -000, -400	# 27287, -000, -400	# 27283, -000, -400
-	-	-	-	-
-	# 27113, -000, -400	-	-	-
-	-	-	-	-
Raindance Select S 300 2jet	Raindance E 360 Air 1jet	Raindance Select E 300 2jet	Raindance E 360 Air 1jet	Raindance Select E 300 2jet
Ø 300 mm	360 mm x 190 mm	300 mm x 160 mm	360 mm x 190 mm	300 mm x 160 mm
RainAir Rain	RainAir	RainAir Rain	RainAir	RainAir Rain
15 l/min	17 l/min	17 l/min	17 l/min	16 l/min
■	-	■	-	■
■	-	■	-	■
■	-	-	-	-
460 mm	380 mm	380 mm	380 mm	380 mm
Raindance Select S 120 3jet	Raindance Select E 120 3jet	Raindance Select E 120 3jet	Raindance Select E 120 3jet	Raindance Select E 120 3jet
Isiflex 160 cm	Isiflex 160 cm	Isiflex 160 cm	Isiflex 160 cm	Isiflex 160 cm
EcoStat Comfort	EcoStat Select	EcoStat Select	ShowerTablet Select 300	ShowerTablet Select 300
■	-	-	-	-
■	■	■	■	■
■	■	■	■	■
■	■	■	■	■

**Raindance® E**

**Rainmaker® Select**



<b>Raindance® Select E 300 3jet</b> Showerpipe	<b>Raindance® E 420 2jet</b> Showerpipe	<b>Rainmaker® Select 420 2jet</b> Showerpipe	<b>Rainmaker® Select 460 2jet</b> Showerpipe	<b>Rainmaker® Select 460 3jet</b> Showerpipe
# 27127, -000, -400	# 27149, -000	# 27168, -400	# 27109, -400	# 27106, -400
-	-	-	# 27028, -400	# 27029, -400
-	-	-	-	-
-	-	-	-	-
-	-	-	-	-
Raindance Select E 300 3jet	Raindance E 420 Air 2jet	Raindance E 420 2jet	Rainmaker Select 460 2jet	Rainmaker Select 460 3jet
300 mm x 190 mm	420 mm x 220 mm	420 mm x 220 mm	460 mm x 300 mm	460 mm x 300 mm
RainAir Rain RainStream	RainAir RainFlow	RainAir RainFlow	Rain XL RainStream	Rain XL RainStream Mono
19 l/min	22 l/min	22 l/min	22 l/min	22 l/min
■	-	-	-	-
■	-	■	■	■
-	-	-	-	-
380 mm	450 mm	450 mm	450 mm	450 mm
Raindance Select E 120 3jet	PuraVida 120 1jet	Raindance Select S 120	Raindance Select S 120	Raindance Select S 120
Isiflex 160 cm	Isiflex 160 cm	Isiflex 160 cm	Isiflex 160 cm	Isiflex 160 cm
ShowerTablet Select 300	EcoStat	ShowerTablet Select 700	ShowerTablet Select 700	ShowerTablet Select 700
-	-	-	-	-
■	■	■	■	■
■	■	■	■	■
■	■	■	■	■

Croma® Select S 180 2jet Showerpipe



# Set to all-round comfort

**Select**

Select the spray types



**Rain:** a strong spray to freshen up and for hair-washing.



**IntenseRain:** a powerful spray for a revitalising start to the day.



Modern design in a white/chrome finish

**Select**

Select the spray types



**SoftRain:** a soft water spray that caresses the body for that feel-good sensation.



Long attachment for safe, simple fastening of the hand shower

**IntenseRain:** an intensive water spray that is ideal for rinsing out shampoo.

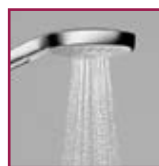

**Massage:** a concentrated spray with a great refreshing effect.



Ecostat Comfort with the ergonomic, durable metal pin handle for clear adjustment of the temperature

**Croma® Select S 180 2jet** Showerpipe



## Advantages and benefits

- Complete system with overhead shower, hand shower and thermostat
- Overhead shower swivels, so can be positioned as desired independently of the connections
- Select technology to change the spray type at the touch of a button
- Five spray types: two from the overhead shower, three from the hand shower
- Can be fitted to existing connections, so ideal for bathroom refurbishments
- Also available in the EcoSmart version with only 9 l/min

**Rainmaker® Select**

**NEW**

**Shower**



**Rainmaker® Select 460 3jet**

Showerpipe  
with Rainmaker Select 460 3jet overhead shower  
(Rain XL: 18 l/min, RainStream: 19 l/min, Mono: 16 l/min),  
Raindance Select S 120 3jet hand shower (14 l/min)  
and ShowerTablet Select 700 thermostat,  
shower arm 450 mm  
# 27106, -400  
# 27029, -400 (9 l/min) EcoSmart

**Rainmaker® Select 460 2jet**

Showerpipe  
with Rainmaker Select 460 2jet overhead shower  
(Rain XL: 18 l/min, RainStream: 19 l/min),  
Raindance Select S 120 3jet hand shower (14 l/min)  
and ShowerTablet Select 700 thermostat,  
shower arm 450 mm  
# 27109, -400  
# 27028, -400 (9 l/min) EcoSmart

**Rainmaker® Select 420 2jet**

Showerpipe  
with Raindance E 420 2jet overhead shower  
(RainAir: 17 l/min, RainFlow: 21 l/min),  
Raindance Select S 120 3jet hand shower (14 l/min)  
and ShowerTablet Select 700 thermostat,  
shower arm 400 mm  
# 27168, -400

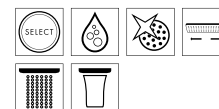
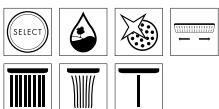

# Raindance® Select E

## Shower



**Raindance® Select E 300 3jet**  
 Showerpipe  
 with Raindance Select E 300 3jet overhead shower  
 (Rain/RainAir: 16 l/min, RainStream: 19 l/min),  
 Raindance Select E 120 3jet hand shower (16 l/min)  
 and ShowerTablet Select 300 thermostat,  
 shower arm 380 mm  
 # 27127, -000, -400



**Raindance® Select E 300 ST**  
 Showerpipe  
 with Raindance Select E 300 2jet overhead shower  
 (16 l/min), Raindance Select E 120 3jet hand shower  
 (16 l/min) and ShowerTablet Select 300 thermostat,  
 shower arm 380 mm  
 # 27126, -000, -400  
 # 27283, -000, -400 (9 l/min) EcoSmart



**Raindance® Select E 360 ST**  
 Showerpipe  
 with Raindance E 360 1jet overhead shower (17 l/min),  
 Raindance Select E 120 3jet hand shower (16 l/min)  
 and ShowerTablet Select 300 thermostat,  
 shower arm 380 mm  
 # 27288, -000, -400  
 # 27287, -000, -400 (9 l/min) EcoSmart

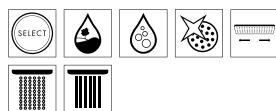
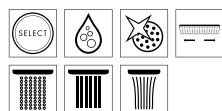

## Raindance® Select E

### Shower



#### Raindance® Select E 300 2jet

Showerpipe  
with Raindance Select E 300 2jet overhead shower  
(17 l/min), Raindance Select E 120 3jet hand shower  
(16 l/min) and Ecostat Select thermostat,  
shower arm 380 mm  
# 27128, -000, -400  
# 27282, -000, -400 (9 l/min) EcoSmart



#### Raindance® Select E 360 1jet

Showerpipe  
with Raindance E 360 1jet overhead shower (17 l/min),  
Raindance Select E 120 3jet hand shower (16 l/min)  
and Ecostat Select thermostat, shower arm 380 mm  
# 27112, -000, -400  
# 27116, -000 (9 l/min) EcoSmart

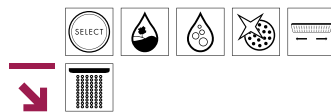
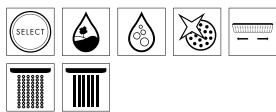

- Rectangular shower with shoulder width rain for full body coverage

## Raindance® Select S

### Shower



**Raindance® Select S 300 2jet**  
 Showerpipe  
 with swivelling Raindance Select S 300 2jet overhead  
 shower (15 l/min), Raindance Select S 120 3jet hand  
 shower (16 l/min) and Ecostat Comfort thermostat,  
 shower arm 460 mm  
 # 27133, -000, -400  
 Height of the Showerpipe can be reduced

**Raindance® Select S 240 2jet**  
 Showerpipe  
 with swivelling Raindance Select S 240 2jet overhead  
 shower (15 l/min), Raindance Select S 120 3jet hand  
 shower (16 l/min) and Ecostat Comfort thermostat,  
 shower arm 460 mm  
 # 27129, -000, -400 (not shown)  
 Height of the Showerpipe can be reduced



**Raindance® Select S 300 1jet**  
 Showerpipe  
 with swivelling Raindance S 300 1jet overhead  
 shower (17 l/min), Raindance Select S 120 3jet hand  
 shower (16 l/min) and Ecostat Comfort thermostat,  
 shower arm 460 mm  
 # 27114, -000  
 Height of the Showerpipe can be reduced



**Raindance® Select S 240 1jet**  
 Showerpipe  
 with swivelling Raindance S 240 1jet overhead  
 shower (17 l/min), Raindance Select S 120 3jet hand  
 shower (16 l/min) and Ecostat Comfort thermostat,  
 shower arm 460 mm  
 # 27115, -000  
 Height of the Showerpipe can be reduced

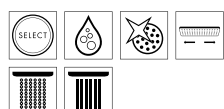

- Overhead shower can be swivelled away for soaping or washing hair
- Off-centre installation possible



- Overhead shower can be swivelled away for soaping or washing hair
- Off-centre installation possible



# Raindance® E/Raindance®

## Shower/Universal



**Raindance® E 420 2jet**  
 Showerpipe  
 with Raindance E 420 2jet overhead shower  
 (RainAir: 18 l/min, RainFlow: 22 l/min),  
 baton hand shower 1jet (16 l/min)  
 and thermostat, shower arm 380 mm  
 # 27149, -000



**Raindance® 240 Air 1jet**  
 Showerpipe  
 with swivelling overhead shower Raindance  
 S 240 Air 1jet (17 l/min), Raindance S 100 Air 3jet  
 hand shower (13 l/min) and concealed thermostat,  
 shower arm 460 mm  
 # 27145, -000  
 Height of the Showerpipe can be reduced



**Raindance® Connect S 240 Air 1jet**  
 Showerpipe  
 with Raindance S 240 Air 1jet overhead shower  
 (14 l/min), baton hand shower 2jet (17 l/min)  
 # 27164, -000 Shower arm 460 mm  
 # 27421, -000 Shower arm 350 mm (not shown)  
 # 27158, -000 Corner installation set (not shown)  
 Height of the Showerpipe can be reduced

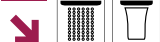

- With concentrated flood jet



- Optimal for upgrading bathrooms with existing iBox universal installation
- Swivelling overhead shower



- Easy retrofit where hand shower is already installed
- Perfect for renovations

**Croma® Select E**

**NEW**

**Shower/Bath**



**Croma® Select E 180 2jet**  
 Showerpipe  
 with swivelling Croma Select E 180 2jet overhead  
 shower (Rain/IntenseRain: 16 l/min), Croma Select E  
 Multi hand shower (13 l/min) and Ecostat Comfort  
 thermostat, shower arm 400 mm  
 # 27256, -400  
 # 27257, -400 (9 l/min) EcoSmart  
 Height of the Showerpipe can be reduced

**Croma® Select E 180 2jet**  
 Showerpipe  
 with swivelling Croma Select E 180 2jet overhead  
 shower (Rain/IntenseRain: 16 l/min), Croma Select E  
 Multi hand shower (13 l/min) and single lever mixer,  
 shower arm 400 mm  
 # 27258, -400  
 Height of the Showerpipe can be reduced

**Croma® Select E Multi**  
 Semipipe  
 with Croma Select E Multi hand shower (16 l/min)  
 and Ecostat Comfort thermostat  
 # 27248, -400  
 # 27259, -400 (9 l/min) EcoSmart

**Croma® Select E 180 2jet**  
 Showerpipe  
 # 27352, -400 with Ecostat Comfort bath thermostat  
 (not shown)  
 Height of the Showerpipe can be reduced

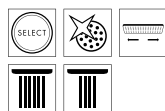

- The bar doubles as a handle for safe showering
- Solid attachment, ideal for hotels

**Croma® Select S**

**NEW**

**Shower/Bath**



**Croma® Select S 180 2jet**  
 Showerpipe  
 with swivelling Croma Select S 180 2jet overhead shower (Rain/IntenseRain: 16 l/min), Croma Select S Multi hand shower (13 l/min) and Ecostat Comfort thermostat, shower arm 400 mm  
 # 27253, -400  
 # 27254, -400 (9 l/min) EcoSmart  
 Height of the Showerpipe can be reduced

**Croma® Select S 180 2jet**  
 Showerpipe  
 with swivelling Croma Select S 180 2jet overhead shower (Rain/IntenseRain: 16 l/min), Croma Select S Multi hand shower (13 l/min) and single lever mixer, shower arm 400 mm  
 # 27255, -400  
 Height of the Showerpipe can be reduced

**Croma® Select S Multi**  
 Semipipe  
 with Croma Select S Multi hand shower (16 l/min) and Ecostat Comfort thermostat  
 # 27247, -400  
 # 27249, -400 (9 l/min) EcoSmart

**Croma® Select S 180 2jet**  
 Showerpipe  
 # 27351, -400 with Ecostat Comfort bath thermostat (not shown)  
 Height of the Showerpipe can be reduced

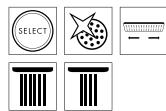

- The bar doubles as a handle for safe showering
- Solid attachment, ideal for hotels

All specified flow rates are based on a pressure of 0.3 MPa (3 bar) upstream of the mixer.

**Croma® 220**

**Shower**



**Croma® 220 Air 1jet**  
 Showerpipe  
 with swivelling Croma 220 Air 1jet overhead shower  
 (19 l/min), Croma 100 Vario hand shower  
 (15 l/min) and Ecostat Comfort thermostat,  
 shower arm 400 mm  
 # 27185, -000  
 # 27188, -000 EcoSmart  
 Height of the Showerpipe can be reduced



**Croma® 220 Air 1jet**  
 Showerpipe  
 with swivelling Croma 220 Air 1jet overhead shower  
 (19 l/min), Croma 100 Vario hand shower  
 (15 l/min) and single lever mixer,  
 shower arm 400 mm  
 # 27222, -000  
 Height of the Showerpipe can be reduced



**Croma® 220 Air 1jet**  
 Showerpipe Reno  
 with swivelling Croma 220 Air 1jet overhead shower  
 (16 l/min), Croma 100 Vario hand shower (15 l/min),  
 without mixer, shower arm 400 mm  
 # 27224, -000  
 # 27158, -000 Corner installation set (not shown)  
 Height of the Showerpipe can be reduced



- Overhead shower can be swivelled away for soaping or washing hair
- Off-centre installation possible



- Easy retrofit on existing mixers
- Swivelling overhead shower

**Croma® 160**

**Shower**



**Croma® 160 1jet**  
 Showerpipe  
 with Croma 160 1jet overhead shower (17 l/min),  
 Croma 100 Vario hand shower (15 l/min)  
 and Ecostat Comfort thermostat, shower arm 270 mm  
 # 27135, -000  
 # 27238, -000 (9 l/min) EcoSmart  
 Height of the Showerpipe can be reduced

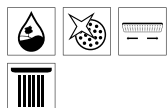

**Croma® 160 1jet**  
 Showerpipe  
 with Croma 160 1jet overhead shower (17 l/min),  
 Croma 100 Vario hand shower (15 l/min)  
 and single lever mixer, shower arm 270 mm  
 # 27154, -000  
 Height of the Showerpipe can be reduced

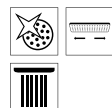

**Crometta® 160**

**NEW**

**Shower**



**Crometta® 160 1jet**  
 Showerpipe  
 with overhead shower Crometta 160 1jet, Crometta  
 100 Vario hand shower and Ecostat Universal  
 thermostat  
 # 27264, -400  
 # 27265, -400 (9 l/min) EcoSmart  
 Height of the Showerpipe can be reduced

**Crometta® 160 1jet**  
 Showerpipe  
 with overhead shower Crometta 160 1jet, Crometta  
 100 Vario hand shower and single lever mixer  
 # 27266, -400 (not shown)  
 Height of the Showerpipe can be reduced

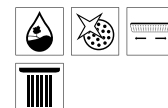

## Raindance® Select E/Raindance® Select S/Croma®

### Bath



**Raindance® Select E 360 1jet**  
Showerpipe  
with Raindance E 360 1jet overhead shower  
(17 l/min), Raindance Select E 120 3jet hand  
shower (16 l/min) and Ecostat Select bath thermostat  
(20 l/min), shower arm 380 mm  
# 27113, -000, -400



**Raindance® Select S 240 1jet**  
Showerpipe  
with swivelling Raindance S 240 1jet overhead  
shower (17 l/min), Raindance Select S 120 3jet hand  
shower (16 l/min) and Ecostat Comfort bath thermostat  
(20 l/min), shower arm 460 mm  
# 27117, -000  
Height of the Showerpipe can be reduced



**Croma® 220 Air 1jet**  
Showerpipe  
with swivelling Croma 220 Air 1jet overhead shower  
(17 l/min), Croma 100 Vario hand shower  
(15 l/min), Ecostat Comfort bath thermostat  
(20 l/min), shower arm 400 mm  
# 27223, -000  
Height of the Showerpipe can be reduced

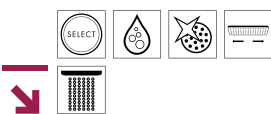

- Full showering in the bath
- Also ideal for renovations

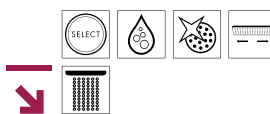

- Optimal installation also on side or offset connections
- Swivelling overhead shower



- Overhead shower can be swivelled away for soaping or washing hair
- Off-centre installation possible

Hansgrohe Showerpanel®

# Made to convince customers on all fronts

Overhead, hand and side showers, various spray types and refreshing all-body massages from the side showers: A Hansgrohe

Showerpanel provides water fun all the way. The fun finds its perfect complement in the uncomplicated installation: Simply retrofit on

the existing connections – wall installations are not necessary. The bathroom will therefore be equipped for shower pleasure in seconds.



200 mm



**Raindance® Lift Showerpanel®**  
with Raindance Rainfall 180 Air 2jet overhead shower (RainAir: 14 l/min, RainFlow: 17 l/min), PuraVida 120 1jet baton hand shower (16 l/min) and thermostat, height adjustable, 200 mm  
# 27008, -000, -400  
# 27003, -400 (9 l/min) EcoSmart



200 mm

**Lift 2 Showerpanel®**  
with Raindance S 180 Air 1jet overhead shower (22 l/min), PuraVida baton hand shower, 6 side showers and thermostat, height adjustable, 200 mm  
# 26871, -000

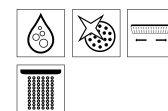

## Advantages and benefits

- Combines overhead, hand, and/or side showers in a single system
- Water fun from all sides
- Up to six side showers
- Various spray types for individual showering enjoyment



**Raindance® S Showerpanel®**  
with Raindance S 150 Air 3jet hand  
shower (17 l/min), 6 side showers  
and exposed thermostat  
# 27005, -000

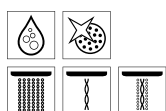



- Straightforward installation with no need to integrate in the wall
- Easy to retrofit on existing connections
- Some versions are height adjustable to suit all body sizes



Hansgrohe exposed thermostats

## The exposed thermostats at a glance

	Ecostat® Universal		Ecostat® 1001 SL		Ecostat® Comfort	
						
Product name	Ecostat® Universal		Ecostat® 1001 SL		Ecostat® Comfort	
Areas of use	Bath	Shower	Bath	Shower	Bath	Shower
Item no.	# 13123, -000	# 13122, -000	# 13241, -000	# 13261, -000	# 13114, -000	# 13116, -000
Scald protection at 40°C	■	■	■	■	■	■
Adjustable temperature limit	■	■	■	■	■	■
Ecostop button	-	■	-	■	-	■
Flow connection hand shower at 3 bar	30 l/min	30 l/min	30 l/min	30 l/min	30 l/min	30 l/min
Flow bath filler at 3 bar	20 l/min		20 l/min		20 l/min	
Change spray type with Select button	-	-	-	-	-	-
Turn to change spray type	■	■	■	■	■	■
Insulated water channel	-	-	-	-	-	-
Shelf made of safety glass	-	-	-	-	-	-
Concealed connection for one function	-	-	-	-	-	-
Uniques	Select	-	-	-	-	-
	AirPower	■	-	■	-	■
	QuickClean	■	-	■	-	■

■ Available. - Not available.

**Ecostat® Select**

**ShowerTablet® Select 300**

**ShowerTablet® Select 700**



Ecostat® Select		ShowerTablet® Select 300		ShowerTablet® Select 700	
Bath	Shower	Bath	Shower	Bath	Universal
# 13141, -000	# 13161, -000	# 13151, -000, -400	# 13171, -000, -400	# 13183, -000, -400	# 13184, -000, -400
▪	▪	▪	▪	▪	▪
▪	▪	▪	▪	▪	▪
-	▪	-	▪	-	▪
30 l/min	30 l/min	30 l/min	30 l/min	30 l/min	30 l/min
20 l/min		20 l/min		20 l/min	
-	-	▪	▪	▪	▪
▪	▪	-	-	-	-
▪	▪	▪	▪	▪	▪
▪	▪	▪	▪	▪	▪
-	-	-	-	-	▪
-	-	▪	▪	▪	▪
▪	-	▪	-	▪	-
▪	-	▪	-	▪	-

ShowerTablet® Select



# The thermostat that redefines easy use

Thanks to the intuitive Select technology everything on the ShowerTablet Select 300 almost happens by itself: Whether you are switching the hand shower on or off in the shower, using the shower or bath filler in the

bathtub, or doing all of these: A simple touch of the button is all it takes to select the function. The Select elements are all easy to operate from the front. Large prints and contrasting colours make it even easier. The control button

is raised when the unit is switched on. This means that it is instantly obvious which function is active. The large, high quality glass shelf is resistant to commercially available bathroom cleaners so will last a lifetime.

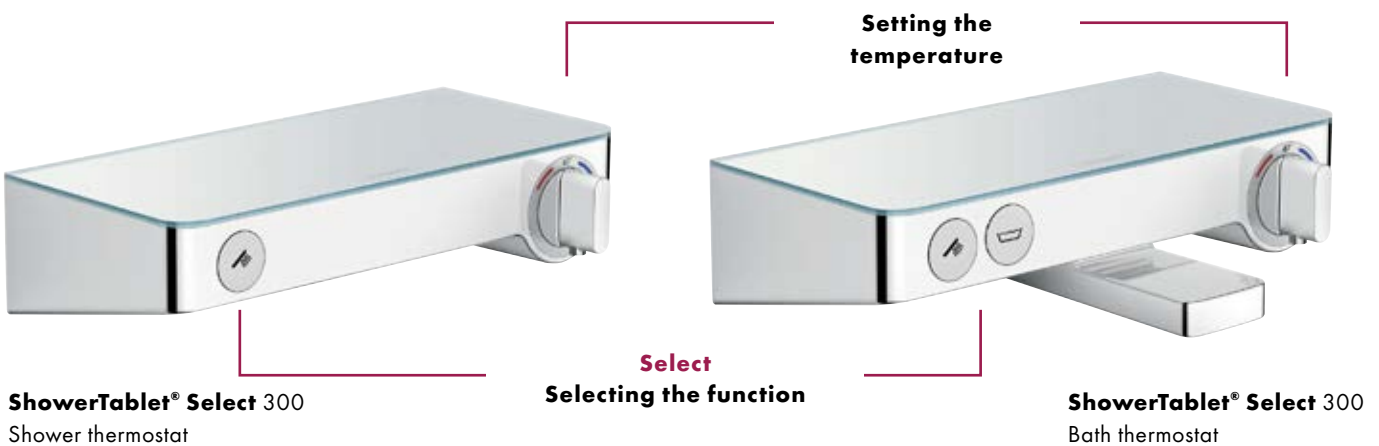

White shelf



Mirrored chrome shelf



Also available as the **ShowerTablet® Select 700**, 700 mm wide, and with the option of selecting two functions. So this version can be used for the elegant concealed installation of a single-spray overhead shower.



## Advantages and benefits

- Simply touch the button to select the function
- The active function can be recognised immediately by the raised control button
- All Select elements can be reached easily from the front
- More than one function can be selected at the same time



**Intuitive:** Thanks to the Select button and temperature control, control is intuitive and easy from the front.



**User-friendly:** The desired temperature can be set precisely with the handy turn control.



**Easy to use:** When switched on, the control button is raised – so the active function can be identified at a glance.



**Clear:** Easy to understand, abrasion-resistant symbols make control easier.



**Safe:** The insulated body with rounded corners protects against heat and knocks.



**Attractive:** The unique design makes the ShowerTablet Select 300 an eye-catcher in the bathroom.



**Practical:** The level surface is made of glass and offers plenty of space for toiletries.



**Easy cleaning:** The housing is sealed to keep dirt out, and the smooth surface is easy to clean.

- Easy to understand, wear resistant symbols for ease of operation
- The level surface is made of safety glass, and offers space for toiletries.
- **Easy to clean:** thanks to the smooth glass surface that is resistant to chemical cleaning agents
- Integrates harmoniously in any shower area

Ecostat® Select



# Design and lots of fun

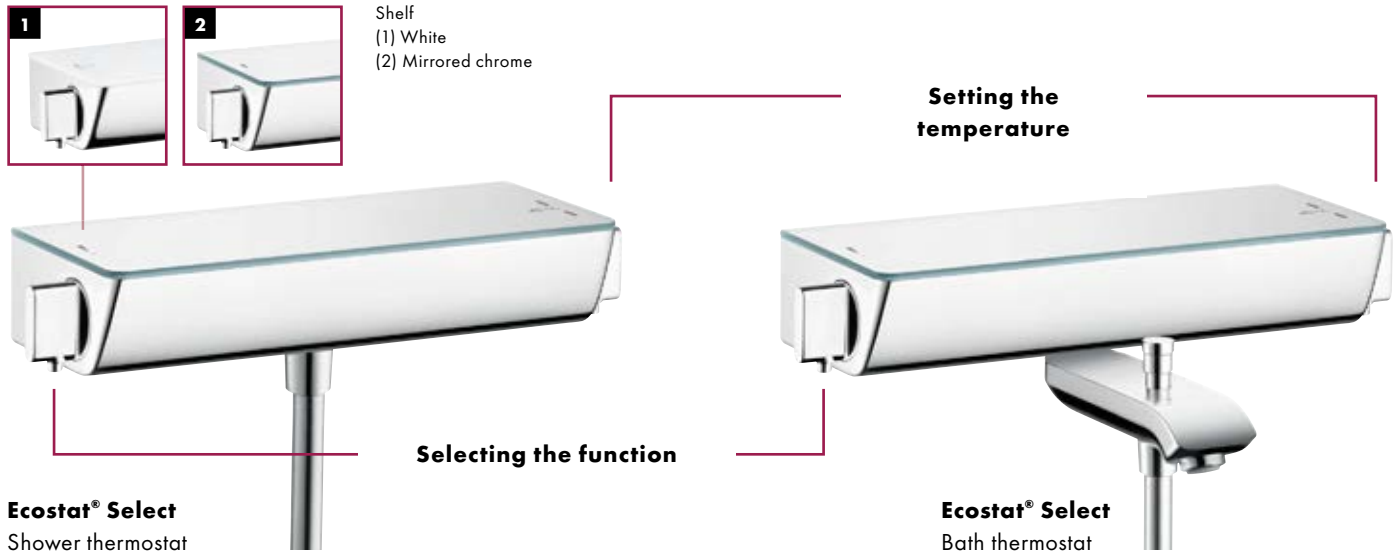

**Safe:** The temperature lock prevents hot water from scalding. In addition, the elegant body is highly insulated. Rounded edges minimise the risk of painful knocks.



**Practical:** The level surface is made of safety glass and offers space for toiletries.



**Economical:** With integrated EcoSmart technology, the flow rate is limited to 10 l/min, for an efficient and refreshing shower.



**User-friendly:** Constant water quantities and temperatures on the highest level of intuitive operability.



## Advantages and benefits

- Visual highlight
- Insulated body remains cool to the touch preventing the risk of injury
- Safe and easy to use for all age groups
- Shelf to store your favourite toiletries
- Water savings made easy
- **Easy cleaning**

## Bath

**NEW**



**ShowerTablet® Select 700**  
Thermostatic bath/shower mixer  
# 13183, -000, -400



**ShowerTablet® Select 300**  
Thermostatic bath/shower mixer  
# 13151, -000, -400



**Ecostat® Select**  
Thermostatic bath/shower mixer  
# 13141, -000, -400



## Shower

**NEW**



**ShowerTablet® Select 700**  
Thermostatic shower mixer  
# 13184, -000, -400



**ShowerTablet® Select 300**  
Thermostatic shower mixer  
# 13171, -000, -400



**Ecostat® Select**  
Thermostatic shower mixer  
# 13161, -000, -400

Thermal disinfection possible  
# 13162, -000 (not shown)

## Shower combinations



**Raindance® Select E 120/  
ShowerTablet® Select 300 Combi Set**  
Shower set with ShowerTablet Select thermostat  
# 27027, -000, -400 0.90 m  
# 27026, -000, -400 0.65 m (not shown)

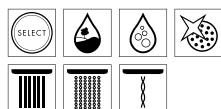

**Raindance® Select S 150/  
Ecostat® Select S Combi Set**  
Shower set with Ecostat Select thermostat  
# 27037, -000, -400 0.90 m  
# 27036, -000, -400 0.65 m (not shown)

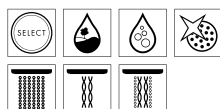

**Raindance® Select E 120/  
Ecostat® Select Combi Set**  
Shower set with Ecostat Select thermostat  
# 27039, -000, -400 0.90 m  
# 27038, -000, -400 0.65 m (not shown)

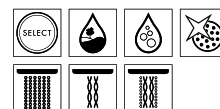

Ecostat® thermostats

# All under control: Thermostatic technology for greater shower pleasure

Hansgrohe offers a large number of exposed thermostats. These not only upgrade the look of bathrooms, they also enhance the comfort of showering. They provide the convenient regulation of flow rate, water pressure and water temperature. Yet the distinct advantage of an exposed thermostat is: This mixer can be installed quickly and easily on existing connections.

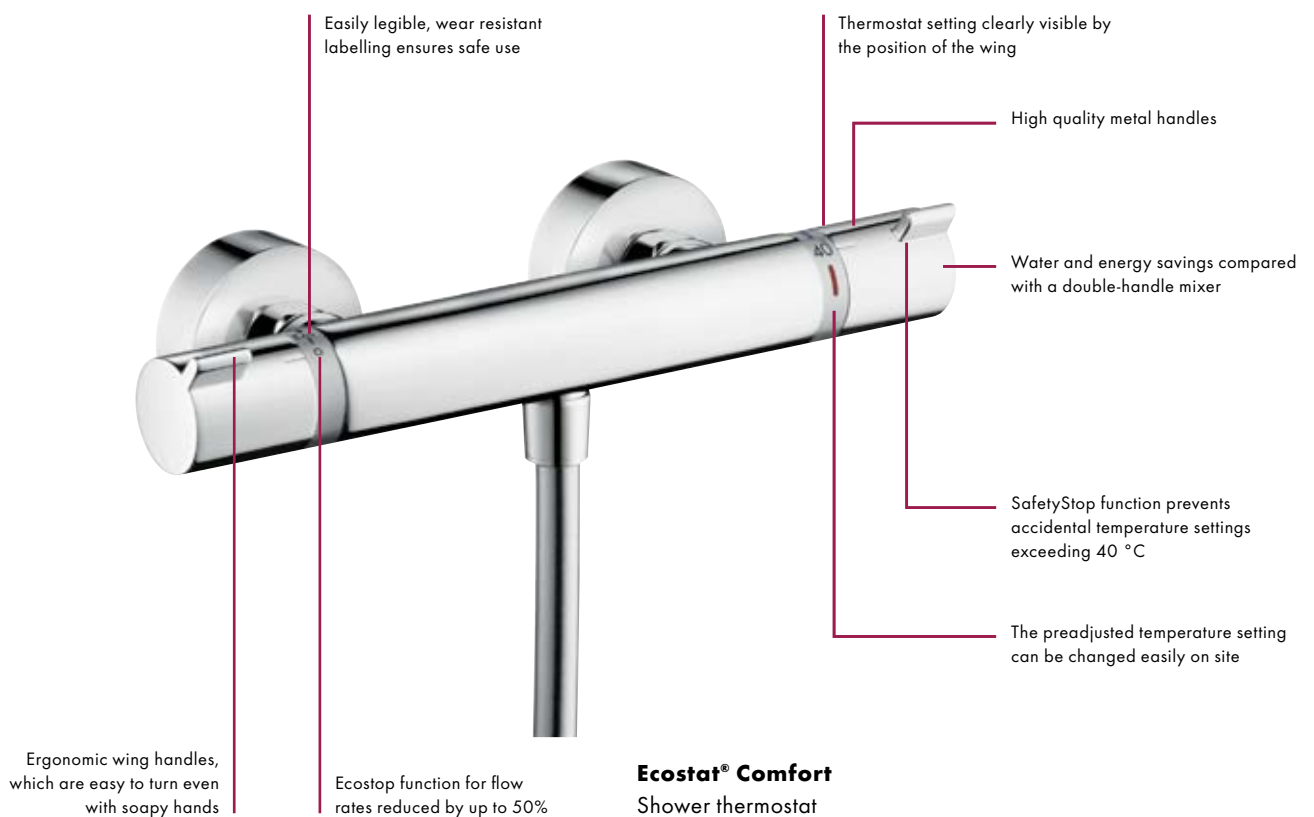

## Advantages and benefits

- Visual and technical upgrade of the bathroom
- Water and energy savings compared with single lever mixers
- Convenient preset temperature
- Temperatures kept constant, so no scalding even when pressure/temperature fluctuates in the water supply

## Bath



**Ecostat® Comfort**  
Thermostatic bath/shower mixer  
# 13114, -000



**Ecostat® 1001 SL**  
Thermostatic bath/shower mixer  
# 13241, -000



**Ecostat® Universal**  
Thermostatic bath/shower mixer  
# 13123, -000



**Ecostat® Comfort Care**  
Thermostatic bath/shower mixer  
# 13115, -000



## Shower



**Ecostat® Comfort**  
Thermostatic shower mixer  
# 13116, -000



**Ecostat® 1001 SL**  
Thermostatic shower mixer  
# 13261, -000



**Ecostat® Universal**  
Thermostatic shower mixer  
# 13122, -000



**Ecostat® Comfort Care**  
Thermostatic shower mixer  
# 13117, -000



## Shower combinations



**Croma® Select E Vario** Combi Set  
with Ecostat Comfort thermostat  
# 27082, -400 0.90 m  
# 27081, -400 0.65 m (not shown)

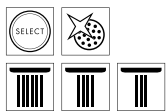

**Croma® Select S Vario** Combi Set  
with Ecostat Comfort thermostat  
# 27014, -400 0.90 m  
# 27013, -400 0.65 m (not shown)

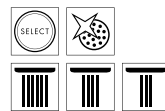

**Croma® 100 Vario** Combi Set  
with Ecostat Comfort thermostat  
# 27035, -000 0.90 m  
# 27033, -000 0.90 m (9 l/min) EcoSmart  
# 27034, -000 0.65 m (not shown)  
# 27032, -000 0.65 m (9 l/min) EcoSmart (not shown)

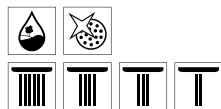

**Croma® 100 Multi** Combi Set  
with Ecostat 1001 SL thermostat  
# 27085, -000 0.90 m  
# 27086, -000 0.65 m (not shown)

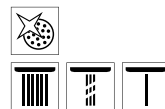

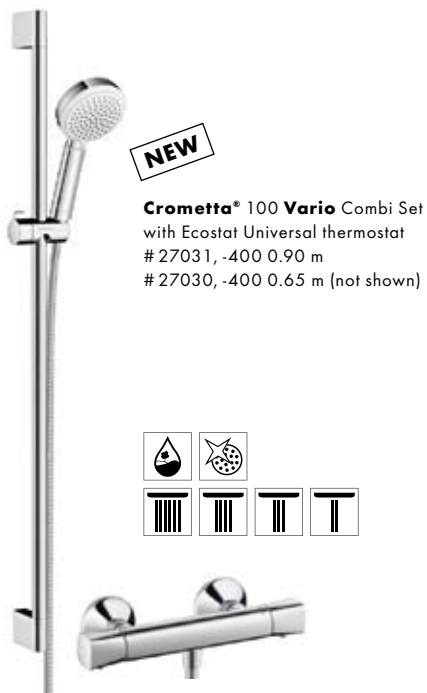

**Crometta® 100 Vario** Combi Set  
with Ecostat Universal thermostat  
# 27031, -400 0.90 m  
# 27030, -400 0.65 m (not shown)

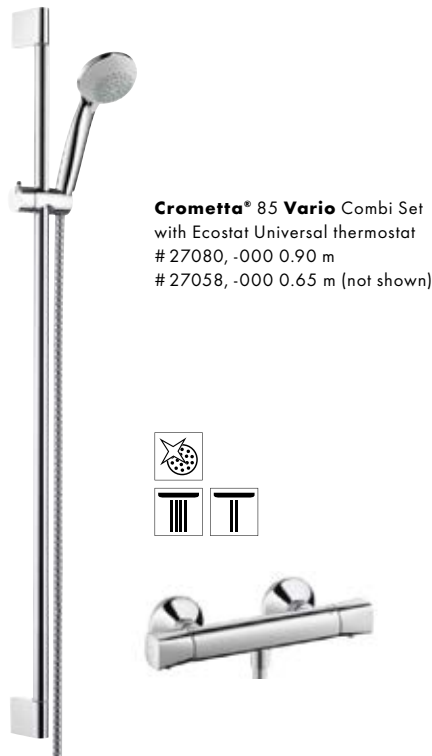

**Crometta® 85 Vario** Combi Set  
with Ecostat Universal thermostat  
# 27080, -000 0.90 m  
# 27058, -000 0.65 m (not shown)



### Advantages and benefits

- Two products combined in one
- Matched in looks and function
- Less expensive than purchasing separately
- Easy order process
- Easy to store



**Under-basin thermostat**  
Exposed  
# 15346, -000



- Easy to connect to existing valves, e.g. under the basin
- Provides a constant temperature and consistent flow even with fluctuating cold water pressure
- Safety e.g. in nursery schools, hospitals or hotels
- Safe for thermal disinfection

Hansgrohe concealed finish sets

NEW

# The right solution for any bathroom

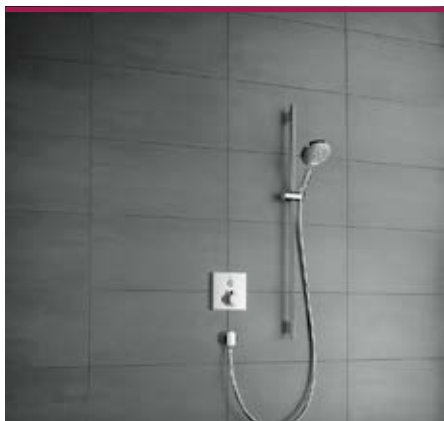

1 function



ShowerSelect® Thermostat



**ShowerSelect®**  
Thermostat  
# 15762, -000

ShowerSelect® Mixer



**ShowerSelect®**  
Mixer  
# 15767, -000

Ecostat® Thermostat



**Ecostat® E**  
Thermostat  
# 15707, -000

ShowerSelect® Thermostat



**ShowerSelect® S**  
Thermostat  
# 15744, -000

ShowerSelect® Mixer



**ShowerSelect® S**  
Mixer  
# 15747, -000

Ecostat® Thermostat



**Ecostat® S**  
Thermostat  
# 15757, -000

You will be able to satisfy any of your customers' requirements – and help them keep to their budgets – with Hansgrohe's complete concealed range for between one and four functions. The choice starts with the operation:

are the showers and spray types to be controlled conventionally by turning, or with complete ease at the touch of a button? Your customers also have complete freedom of design: the ShowerSelect is now also available

in a round design and as a mixer. Ecostat thermostats are available as a circle, and now also as a square with rounded corners. Plenty of options for attractive installations that blend beautifully with the bathroom.



ShowerSelect® Thermostat



**ShowerSelect®**  
Thermostat  
# 15763, -000



**ShowerSelect®**  
Thermostat with  
Fixfit and Porter  
# 15765, -000

ShowerSelect® Mixer



**ShowerSelect®**  
Mixer  
# 15768, -000

Ecostat® Thermostat



**Ecostat® E**  
Thermostat  
# 15708, -000

ShowerSelect® Thermostat



**ShowerSelect® S**  
Thermostat  
# 15743, -000

ShowerSelect® Mixer



**ShowerSelect® S**  
Mixer  
# 15748, -000

Ecostat® Thermostat



**Ecostat® S**  
Thermostat  
# 15758, -000



**3 functions**



ShowerSelect®



**ShowerSelect®**  
Valve  
# 15764, -000



**ShowerSelect®**  
Highflow Thermostat  
# 15760, -000

Ecostat® Thermostat



**iControl® E**  
Valve  
# 15777, -000



**Ecostat® E**  
Highflow Thermostat  
# 15706, -000  
Thermostat  
# 15705, -000 (not shown)

Ecostat® Thermostat



**Trio®/Quattro® E**  
Shut-off/diverter valve  
# 15937, -000



**Ecostat® E**  
Highflow Thermostat  
# 15706, -000  
Thermostat  
# 15705, -000 (not shown)



**Shut-off valve E**  
# 15978, -000

ShowerSelect®



**ShowerSelect® S**  
Valve  
# 15745, -000



**ShowerSelect® S**  
Highflow Thermostat  
# 15741, -000

Ecostat® Thermostat



**iControl® S**  
Valve  
# 15955, -000



**Ecostat® S**  
Highflow Thermostat  
# 15756, -000  
Thermostat  
# 15755, -000 (not shown)

Ecostat® Thermostat



**Trio®/Quattro® S**  
Shut-off/diverter valve  
# 15932, -000



**Ecostat® S**  
Highflow Thermostat  
# 15756, -000  
Thermostat  
# 15755, -000 (not shown)



**Shut-off valve S**  
# 15972, -000



**4 functions**



ShowerSelect®



**ShowerSelect®**  
Valve  
# 15764, -000



**ShowerSelect®**  
Highflow Thermostat  
# 15761, -000

Ecostat® Thermostat



**iControl® E**  
Valve  
# 15777, -000



**Ecostat® E**  
Highflow Thermostat  
# 15706, -000



**Shut-off valve E**  
# 15978, -000

Ecostat® Thermostat



**Trio®/Quattro® E**  
Shut-off/diverter valve  
# 15937, -000



**Shut-off valve E**  
# 15978, -000



**Ecostat® E**  
Highflow Thermostat  
# 15706, -000



**Shut-off valve E**  
# 15978, -000

ShowerSelect®



**ShowerSelect® S**  
Valve  
# 15745, -000



**ShowerSelect® S**  
Highflow Thermostat  
# 15742, -000

Ecostat® Thermostat



**iControl® S**  
Valve  
# 15955, -000



**Ecostat® S**  
Highflow Thermostat  
# 15756, -000



**Shut-off valve S**  
# 15972, -000

Ecostat® Thermostat



**Trio®/Quattro® S**  
Shut-off/diverter valve  
# 15932, -000



**Shut-off valve S**  
# 15972, -000



**Ecostat® S**  
Highflow Thermostat  
# 15756, -000



**Shut-off valve S**  
# 15972, -000

ShowerSelect® Thermostat with Fixfit® and Porter

**NEW**

# The easy way to control pleasure



## ShowerSelect®

Thermostat with Fixfit and Porter  
Escutcheon size 155 mm x 188 mm

### Advantages and benefits

- Unique installation: integrated Fixfit hose connection and Porter for added comfort
- Optimum solution for the shower: no separate drilling for pipe connections or shower holder. Installation based on the iBox universal.
- Metal escutcheon, hose connection for all G ½ hoses
- Two-tone effect as a result of the contrast between chrome-coloured escutcheons and matt buttons. The easy-to-read temperature display makes operation much easier
- Manually adjustable temperature limit
- Simultaneous selection of both functions



ShowerSelect® Concealed finish sets

# Operation in all its tremendous variety

## ShowerSelect®

Thermostat for 2 functions  
Escutcheon size 155 mm x 155 mm

**NEW**

## ShowerSelect® S

Mixer for 2 functions  
Escutcheon diameter 150 mm

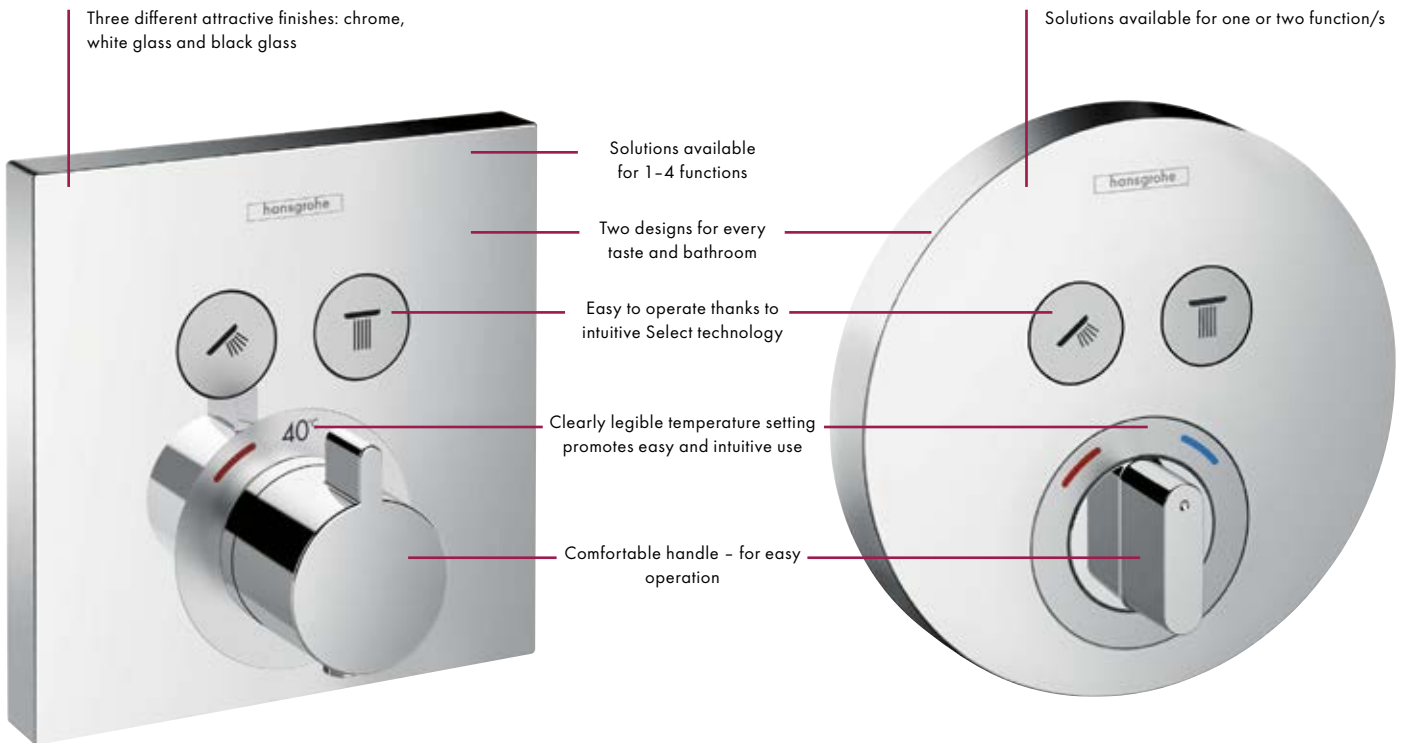

- Constant water temperature even with fluctuating water pressure
- Temperature limited at 40°C, a higher temperature can be set by touching the button on the underside of the handle
- Safe for thermal disinfection
- Plastic escutcheon and metal handle

- For pipes with stable water pressure
- Unique product: Mixer technology with a new handle design, so it can be used with any mixer and shower line
- Easy temperature adjustment
- The depth of the metal handle does not depend on the installation depth of the iBox universal
- Fluctuating water pressures are no problem for the high quality Hansgrohe cartridges



## Advantages and benefits

- Two different technologies: thermostat or mixer
- Printed temperature and button displays will not rub off
- Combinations for any shower situation: pictogram buttons for choosing functions included
- Installation based on the iBox universal
- Recommended operating pressure of the Select valves between 0.1 and 0.5 MPa max.



## Lots of advantages – lots of benefits



**Intuitive:** Easy-to-use Select buttons for intuitive, comfortable control – even for those with restricted mobility.



**Clear:** Easy to understand, abrasion-resistant symbols make control easier.



**Easy to use:** The protruding button instantly reveals the active function. Can be controlled using an elbow or fist thanks to the button extension that is included in the box.



**User-friendly:** The desired temperature can be set precisely with the user-friendly handle.



**Easy cleaning:** The flush-fit buttons leave a flat surface that is easy to clean.



**Attractive:** The rectangular shape blends perfectly with a tiled bathroom and will also go in many modern bathroom designs.



**Economical:** The easy-to-push button encourages the user to switch the water off frequently, which helps to save water.



**User-friendly:** The functions can all be used at the same time – for even greater shower pleasure.



### Advantages and benefits

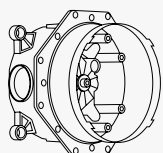

- Two different technologies: thermostat or mixer
- Available in a square or round design – for any taste, style and shower type
- Three attractive finishes: chrome, white glass and black glass; even more options in bathroom design, to appeal to even more potential customers
- Large symbols – for clarity

**Attractive finishes for any ambience and taste**



**Chrome:** the timeless classic for any bathroom.



**White glass:** Stylish and luxurious – an eye-catcher in the bathroom that matches any white/chrome shower, and is especially effective when combined with the Rainmaker Select overhead showers and PuraVida basin mixers.



**Black glass:** Modern and elegant – a visual highlight in the bathroom that combines perfectly with chrome products.

- Intuitive, easy control at the touch of a button
- Functions can be switched off quickly and easily to save water
- Fast, easy and inexpensive renovations possible by simply replacing the existing finish sets
- High level of comfort by simultaneously setting several functions



The ShowerSelect finish set for 2 functions received not only the "Design Plus Award" and the "iF Award 2014", but also the award of the ZVSHK, the German Central Association Plumbing, Heating and Air Conditioning, for excellent design for users with restricted mobility.

## Thermostats



**ShowerSelect®**  
Thermostat for 1 function  
# 15762, -000  
Escutcheon size 155 mm x 155 mm



**ShowerSelect®**  
Thermostat for 2 functions  
# 15763, -000  
Escutcheon size 155 mm x 155 mm



**ShowerSelect®**  
Thermostat for 2 functions  
with hose connection and shower  
support (Hand shower and flexible  
hose can be chosen freely)  
# 15765, -000  
Escutcheon size 155 mm x 188 mm



**ShowerSelect®**  
Valve for 3 functions  
# 15764, -000  
Escutcheon size 155 mm x 155 mm



**ShowerSelect®**  
Highflow thermostat  
# 15760, -000  
Escutcheon size 155 mm x 155 mm



**ShowerSelect®**  
Highflow Thermostat for 1 function  
(bottom) and 1 additional function (top)  
# 15761, -000  
Escutcheon size 155 mm x 155 mm



**ShowerSelect®**  
Mixer for 1 function  
# 15767, -000  
Escutcheon size 155 mm x 155 mm



**ShowerSelect®**  
Mixer for 2 functions  
# 15768, -000  
Escutcheon size 155 mm x 155 mm



## Thermostats – Glass surface



- Elegant glass surface as a visual highlight
- Flush-fit buttons in the same glass blend seamlessly with the finish set
- The print on the buttons is permanent and will not rub off
- Suitable button combination already in place, special solutions available on request.
- Perfect interplay between the glass surface and shower partitions, mirrors and windows plus the new Rainmaker Select overhead showers for optimum integration in the bathroom
- Select technology for easy control at the touch of a button
- Easy installation based on the iBox universal
- Matches coloured push plates and designer wall-hung WCs



**ShowerSelect®**  
Thermostat for 1 function  
Glass surface  
# 15762, -400, -600  
Escutcheon size 155 mm x 155 mm



**ShowerSelect®**  
Thermostat for 2 functions  
Glass surface  
# 15738, -400, -600  
Escutcheon size 155 mm x 155 mm





**NEW**

**ShowerSelect® S**  
Thermostat for 1 function  
# 15744, -000  
Escutcheon diameter 150 mm



**NEW**

**ShowerSelect® S**  
Thermostat for 2 functions  
# 15743, -000  
Escutcheon diameter 150 mm



**NEW**

**ShowerSelect® S**  
Valve for 3 functions  
# 15745, -000  
Escutcheon diameter 150 mm

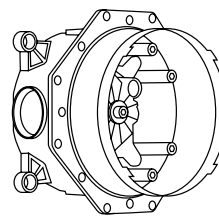

**iBox® universal**  
Basic set iBox universal  
# 01800180  
**Extension set 25 mm for too deep installation:**  
# 13595000  
**Extension set 22 mm for too low installation depths:**  
# 13593000 for ShowerSelect in the dimensions 155 mm x 155 mm  
# 13597000 for ShowerSelect of diameter 150 mm



**NEW**

**ShowerSelect® S**  
Highflow thermostat  
# 15741, -000  
Escutcheon diameter 150 mm



**NEW**

**ShowerSelect® S**  
Highflow Thermostat for 1 function (bottom) and 1 additional function (top)  
# 15742, -000  
Escutcheon diameter 150 mm



**NEW**

**ShowerSelect® S**  
Mixer for 1 function  
# 15747, -000  
Escutcheon diameter 150 mm



**NEW**

**ShowerSelect® S**  
Mixer for 2 functions  
# 15748, -000  
Escutcheon diameter 150 mm



**ShowerSelect®**  
Highflow thermostat  
Glass surface  
# 15734, -400, -600  
Escutcheon size 155 mm x 155 mm



**ShowerSelect®**  
Highflow Thermostat for 1 function (bottom) and 1 additional function (top)  
Glass surface  
# 15735, -400, -600  
Escutcheon size 155 mm x 155 mm



**ShowerSelect®**  
Valve for 3 functions  
Glass surface  
# 15736, -400, -600  
Escutcheon size 155 mm x 155 mm



white/chrome version (-400)



black/chrome version (-600)

Ecostat® concealed finish sets

# Established technology in a new design

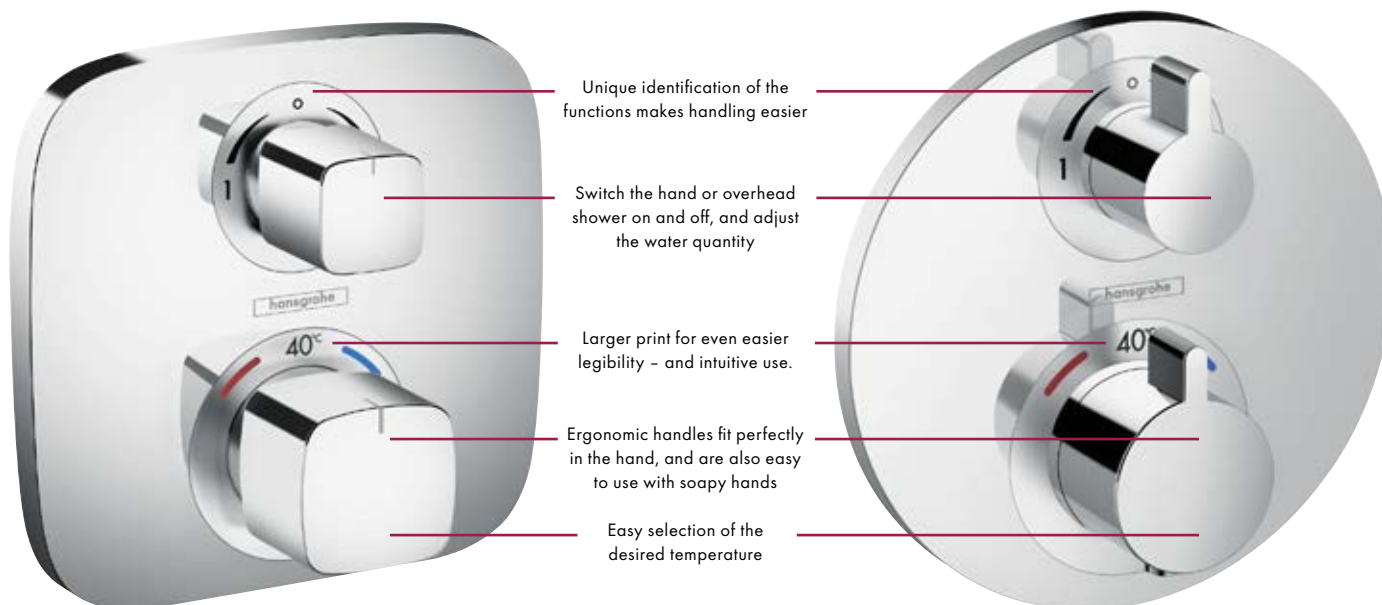

**Ecostat® E:** Thermostat in a square design with rounded corners.

**Ecostat® S:** Thermostat in a round design.



**Easy to use:** Unique identification of the functions makes handling easier.



**Clear:** Larger print for even easier legibility – and intuitive use.



**Safe:** Ergonomic handles fit perfectly in the hand, and are also easy to use with soapy hands.



## Advantages and benefits

- Easy-to-use rotary control for choosing between hand and overhead shower and to control the water quantity
- Precise control of the water temperature – no nasty shocks for the user
- Two design options to suit any bathroom and spray form
- Constant water temperature thanks to thermostat technology
- Size-optimised handles for safe, easy operation



**Ecostat® E**  
Thermostat for 1 function  
# 15707, -000  
Escutcheon size 155 mm x 155 mm



**Ecostat® E**  
Thermostat for 2 functions  
# 15708, -000  
Escutcheon size 155 mm x 155 mm



**Ecostat® E**  
Thermostat  
# 15705, -000  
Highflow thermostat  
# 15706, -000 (not shown)  
Escutcheon size 155 mm x 155 mm



**iControl® E**  
Valve for 3 functions  
# 15777, -000  
Escutcheon size 155 mm x 155 mm



**Ecostat® S**  
Thermostat for 1 function  
# 15757, -000  
Escutcheon diameter 150 mm



**Ecostat® S**  
Thermostat for 2 functions  
# 15758, -000  
Escutcheon diameter 150 mm



**Ecostat® S**  
Thermostat  
# 15755, -000  
Highflow thermostat  
# 15756, -000 (not shown)  
Escutcheon diameter 150 mm



**iControl® S**  
Valve for 3 functions  
# 15955, -000  
Escutcheon diameter 150 mm

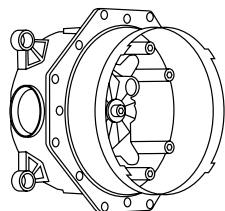

**iBox® universal**  
Basic set iBox universal  
# 01800180  
**Extension set 25 mm for too deep installation:**  
# 13595000  
**Extension set 22 mm for too low installation depths:**  
# 13597000 for escutcheons of diameter 150 mm  
# 15597000 for escutcheons in the dimensions 155 mm x 155 mm



**Ecostat® S**  
Thermostat for 1 function  
# 15701, -000  
Escutcheon diameter  
170 mm



**Ecostat® S**  
Thermostat for 2 functions  
# 15721, -000  
Escutcheon diameter  
170 mm



**Ecostat® S**  
Thermostat  
# 15711, -000  
Highflow thermostat  
# 15715, -000  
(not shown)  
Escutcheon diameter  
170 mm



**Ecostat® Classic**  
Thermostat for 2 functions  
# 15753, -000  
Escutcheon diameter  
170 mm

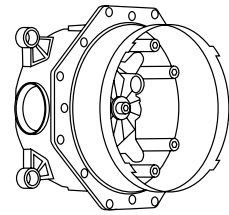

**iBox® universal**  
Basic set iBox universal  
# 01800180  
**Extension set 25 mm for too deep installation:**  
# 13595000  
**Extension set 22 mm for too low installation depths:**  
# 13596000 for escutcheons of diameter 170 mm  
# 13597000 for escutcheons of diameter 150 mm  
# 97407000 for escutcheons of diameter 172 mm  
# 15597000 for PuraVida



**PuraVida®**  
Thermostat for 1 function  
# 15775, -000, -400  
Escutcheon size  
155 mm x 155 mm



**PuraVida®**  
Thermostat for 2 functions  
# 15771, -000, -400  
Escutcheon size  
155 mm x 155 mm



**PuraVida®**  
Thermostat  
# 15770, -000, -400  
Highflow thermostat  
# 15772, -000, -400  
(not shown)  
Escutcheon size  
155 mm x 155 mm



**PuraVida® iControl®**  
Valve for 3 functions  
# 15777, -000, -400  
Escutcheon size  
155 mm x 155 mm



**Metris®**  
Thermostat for 1 function  
# 31572, -000  
Escutcheon diameter  
150 mm



**Metris®**  
Thermostat for 2 functions  
# 31573, -000  
Escutcheon diameter  
150 mm



**Metris®**  
Thermostat  
# 31570, -000  
Highflow thermostat  
# 31571, -000  
(not shown)  
Escutcheon diameter  
150 mm



**Metris® iControl®**  
Valve for 3 functions  
# 31958, -000  
Escutcheon diameter  
150 mm

## Valves



**Trio®/Quattro®**  
Shut-off/diverter valve for PuraVida  
# 15937, -000, -400



**Shut-off valve**  
for PuraVida  
# 15978, -000, -400



**Trio®/Quattro® E**  
Shut-off/diverter valve  
# 31634, -000



**Shut-off valve E**  
# 31677, -000



**Trio®/Quattro® S**  
Shut-off/diverter valve  
# 15932, -000



**Shut-off valve S**  
# 15972, -000



**Shut-off valve**  
for Logis  
# 71970, -000



**Shut-off valve**  
for Logis Classic  
# 71976, -000

iBox® universal

## The universal basis for all concealed installation solutions

With the iBox universal, the mixer technology is concealed in the wall. This not only looks good, but also creates more space and thus greater shower pleasure. Another

advantage is the flexibility of the system and design. The iBox universal may be installed before the decision has been made for a shower system. As the basic set for any

Hansgrohe standard and thermostatic solutions, it is easy to change or upgrade at any time.

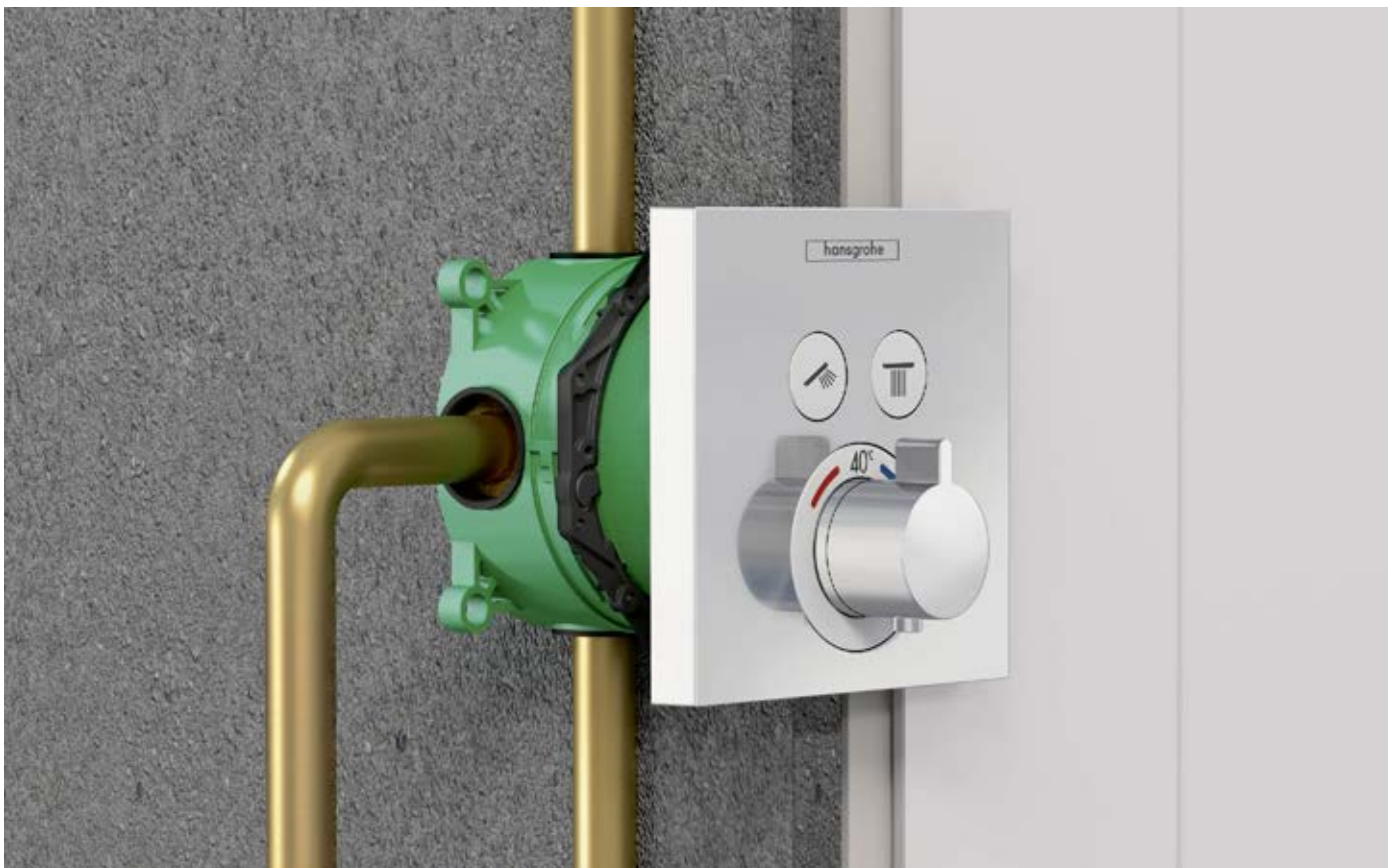

**Concealed installation:** The basic set disappears completely into the wall. Mixers and shower finish sets from various ranges can be fitted to it.

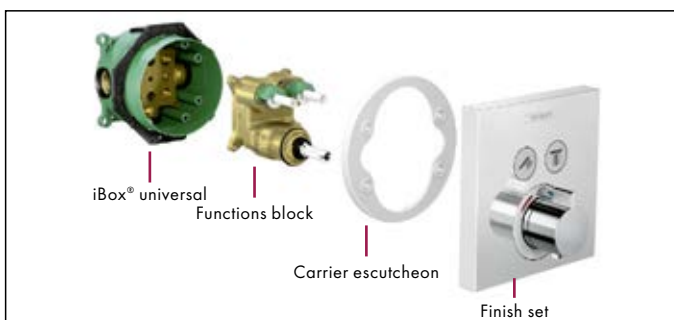

**Over the long term:** The basic set is retained when the bathroom is refurbished. The functions block and finish set can then be easily replaced.





# iBox® universal: one for all

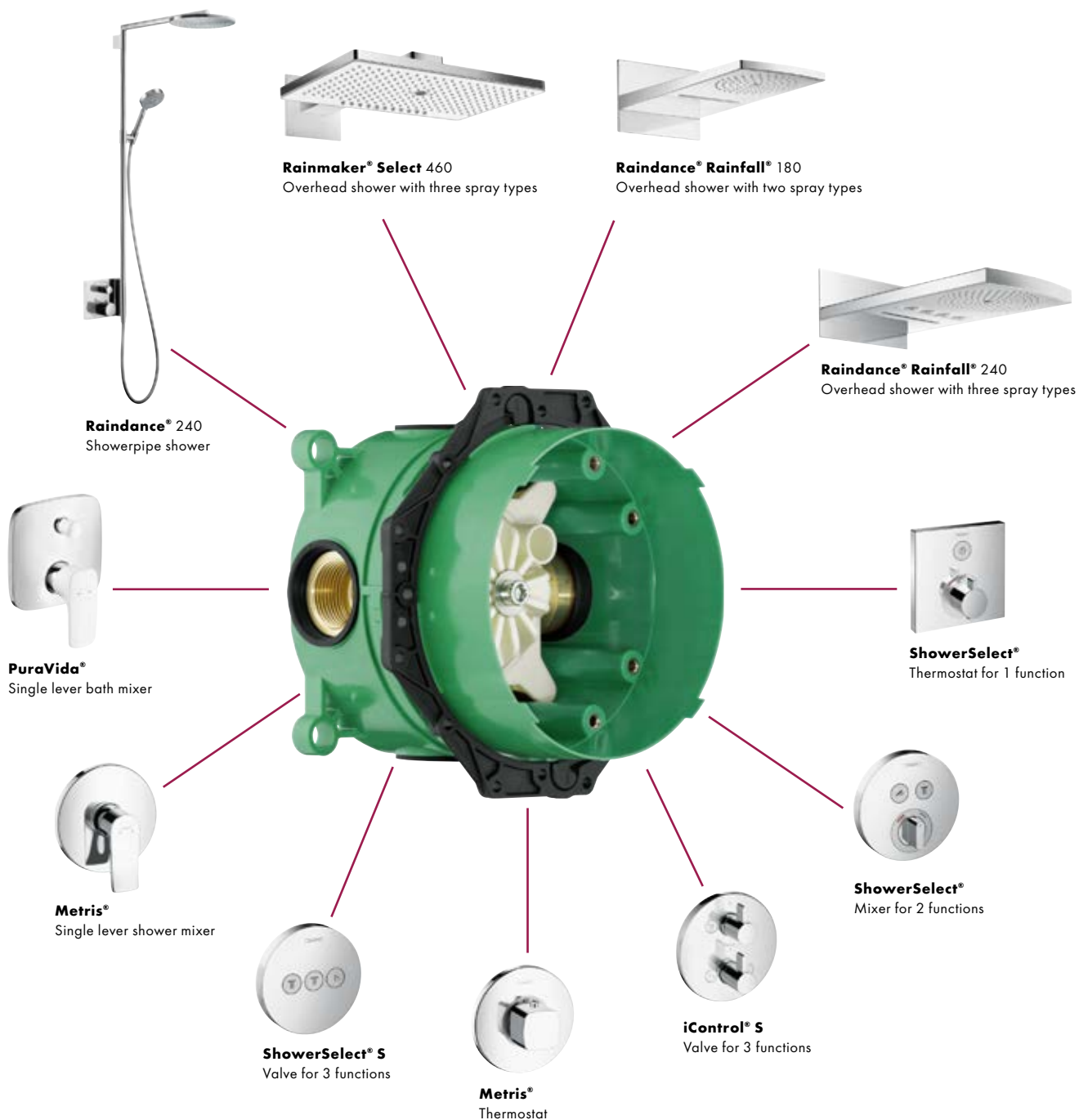

## iBox® universal: convincing on all fronts

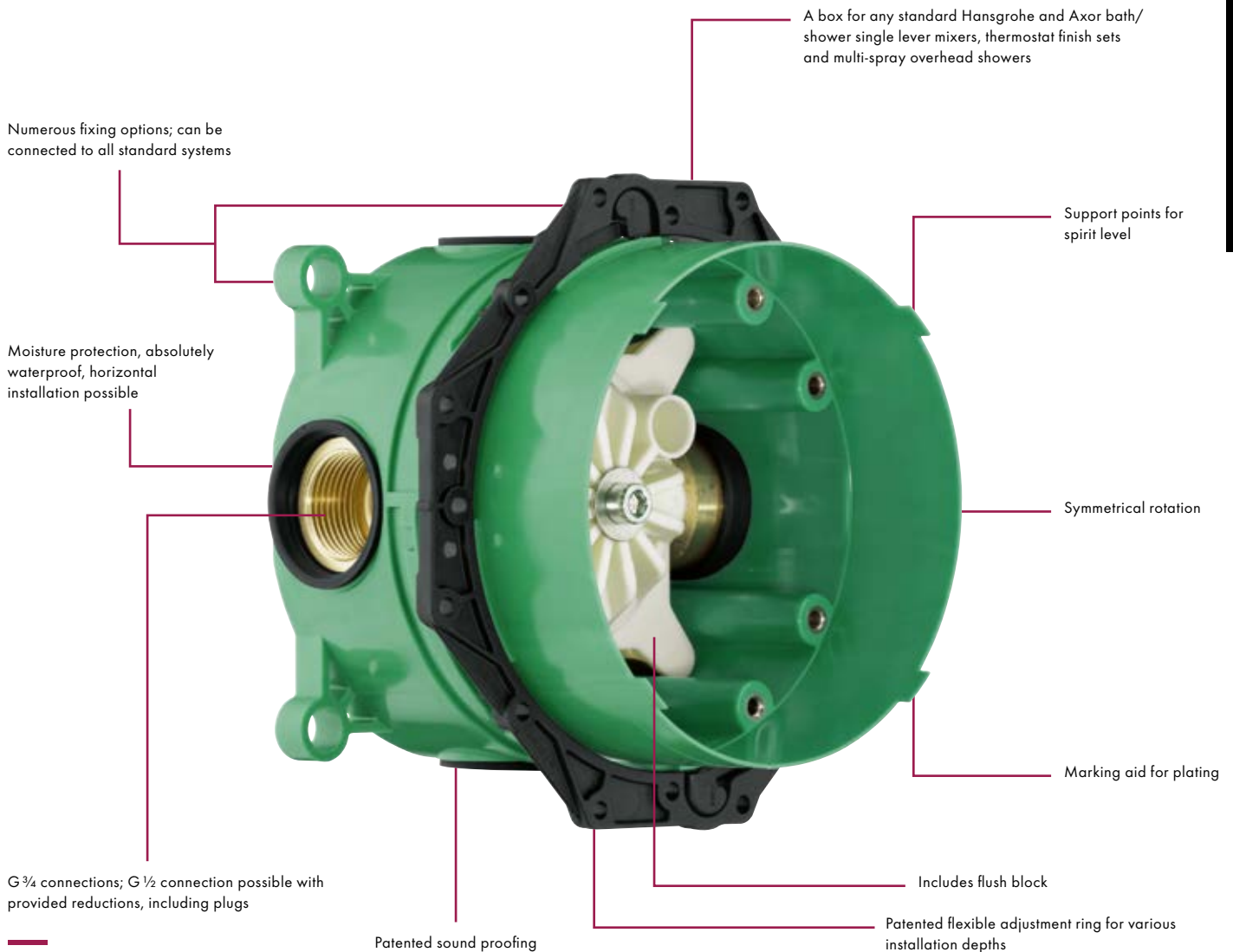

### Advantages and benefits

- One basic set for 16 function solutions
- Suitable for over 200 Hansgrohe and Axor finish sets
- Pre-installation enhances decision making flexibility for mixers
- An attractive bathroom, as bulky technology is out of sight behind the wall
- Greater freedom of movement when showering
- Easy to replace with new mixers or finish set designs when renovating
- Concealed installation solutions tried and tested millions of times

### Advantages and benefits specifically for project activities

- The iBox universal offers a high level of flexibility and lots of design options
- One basic set for all solutions, simplifying project planning
- The iBox is suitable for use in private or public facilities and complies with all the main international standards
- Covers any solution with up to 4 functions

## iBox® universal: the all-rounder with many strengths

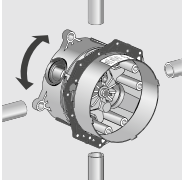

### Rotation-symmetrical installation

- Symmetrical construction; all the connections are the same
- It is important that cold water is connected on the right and hot water on the left
- The lower outlet has priority for bath mixers
- Either the upper or lower outlet can be connected for shower mixers

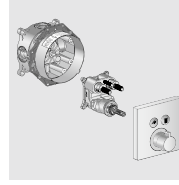

### Safe and economical

- Basic set includes only the connection block
- The valuable functions block is supplied later and mounted with the finish set
- Prevents problems like theft, dirt and frost damage occurring during the building phase and expensive warehousing becomes unnecessary

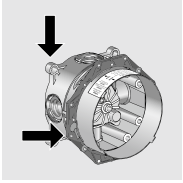

### Many installation types

- Coordinated with to all the standard installation systems, connection types and mixers
- Patented flexible adjustment ring
- Attachment options on 2 levels and G<sup>3/4</sup> connections for universal installation possibilities
- Also suitable for stronger wall constructions and dry wall installations as well as for pre-fabricated houses

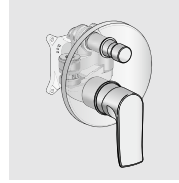

### Integrated safety combination

- Used in conjunction with Exafill baths with an outflow and overflow mixer, it eliminates the need for an external pipe breaker on concealed installation single lever bath mixers: lower installation costs and fewer functional parts in the wall

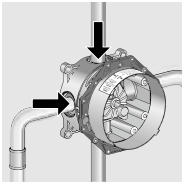

### Perfect moisture protection

- Sealing sleeves on all 4 connections, sealing sleeve under the tiles and the carrier escutcheon that seals against splashes perfectly protect the masonry against moisture on all sides

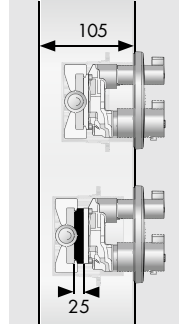

### Solutions for walls that are very deep or very shallow

- If the iBox universal is too deep in the wall, the basic set extension is inserted between the connection and functions block
- The extension set provides safety right up to the wall and perfectly protects the masonry against moisture
- The standard body of the iBox universal has become flatter and is therefore even more suitable for walls with shallow installation depths

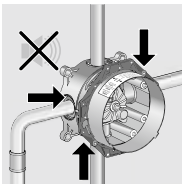

### Low noise levels

- Brass bodies on seals ensure that the noise of water-bearing parts is transferred to the masonry
- The carrier escutcheon is screwed to the housing of the iBox universal and not to the functions block, which means that the noise cannot be transmitted to the tiles

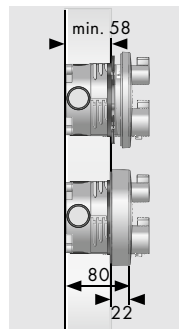

### Collar extension

- Thanks to the extension, even shallow installation depths are no longer a problem
- The extension collar means that the iBox can be installed even in narrow walls

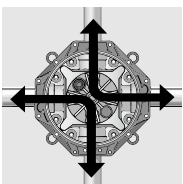

### Easy rinsing

- Flush block included and can be mounted in various different positions. This means that pipes can be flushed through to the end just in front of the wall, as per DIN 1988/EN 1717 part 2

## Attachment options

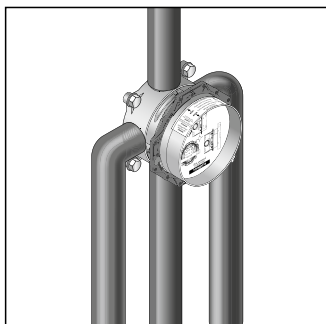

Installation directly on the wall

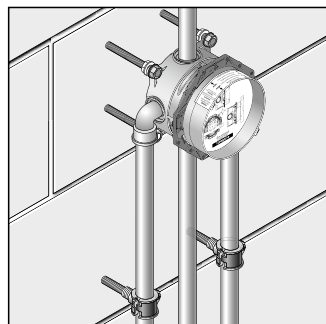
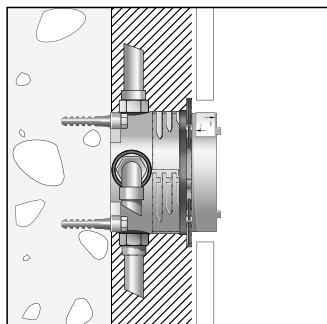

Installation in front of the wall; here with variable spacers on hanger bolts M 10

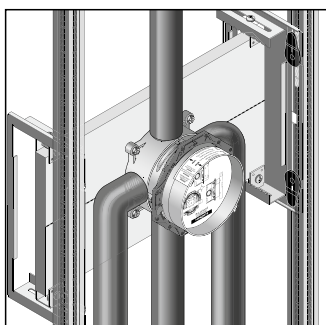
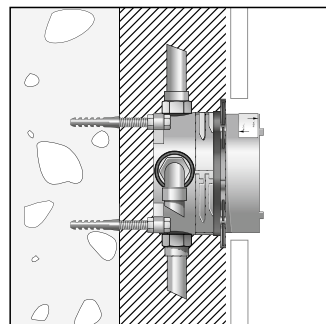

Installation on carrier system

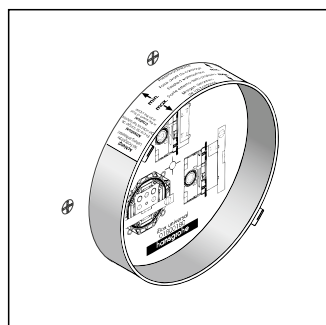
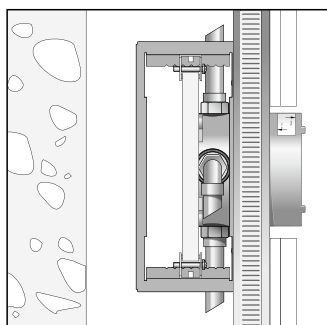

Installation on prefab house mounting panels or prefab shell

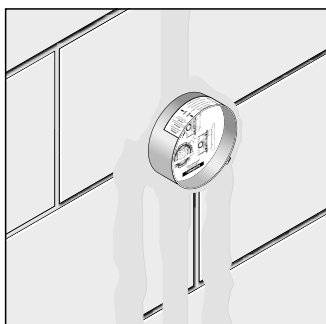
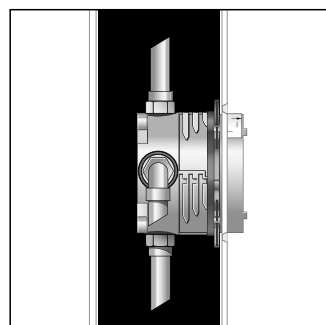

Installation directly in the wall

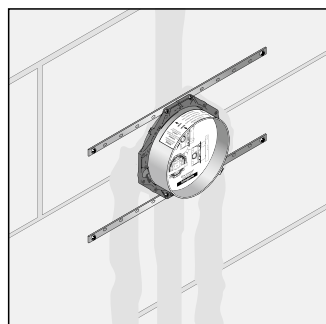
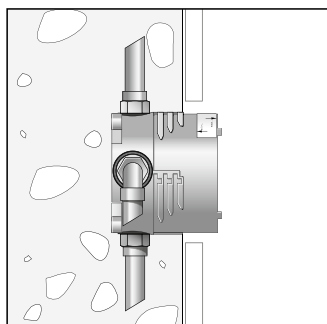

Installation with mounting rail set

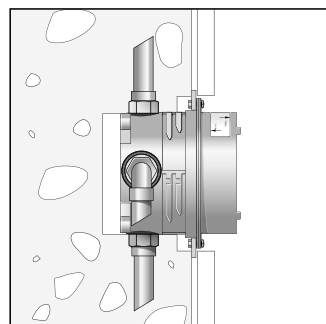

Shower control RainBrain®

# The most intelligent way to enjoy comfort

The RainBrain is an electronic control shower. Whether changing spray types, setting temperatures, selecting the shower music, the RainBrain controls all eventualities with the greatest of ease.

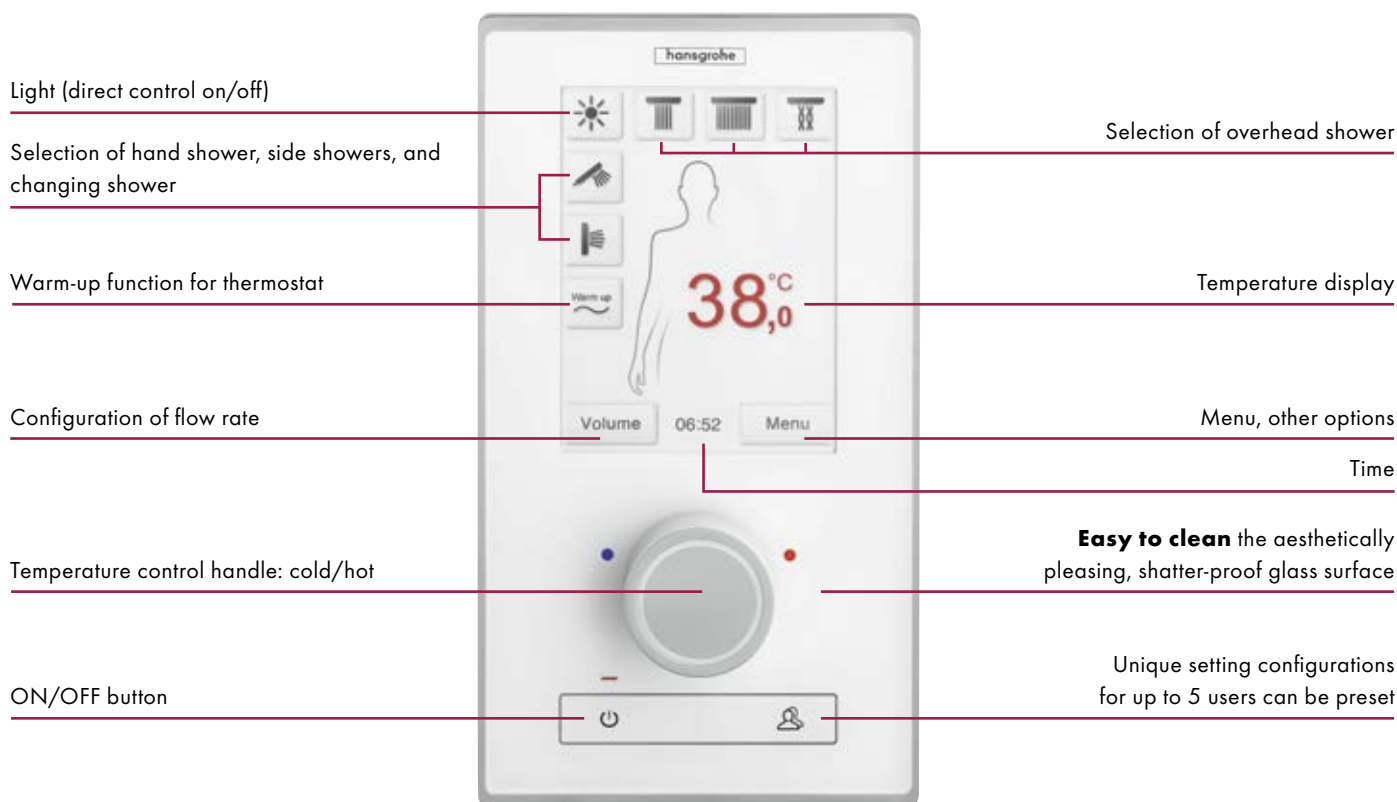

**RainBrain® finish set**  
Electronic shower control for regulating the flow rate  
# 15842, -000, -400

**Installation details**

The RainBrain shower control consists of 4 components, conveniently split into basic and finish set. The basic set contains the connecting bridge for receiving the functions box and an installation case for the operating panel. The finish set contains the functions box and the operating panel.

**Advantages and benefits**

- Technology and design highlight in the bathroom
- Unique touchscreen technology, intuitive use based on self-explanatory symbols
- Easy fingertip control of functions, spray types, light and music
- Individual programmable settings for up to five users
- Contemporary design
- Ease of planning and installation

Find out more at <http://pro.hansgrohe-int.com/rainbrain>

## Installation situation



The electronic shower control Hansgrohe RainBrain consists of a total of four individual components that are divided into basic and finish sets.

### Basic set:

- (3) Connecting bridge for the functions box
- (5) Installation case for the operating panel

### Finish set:

- (4) Functions box
- (6) Operating panel

The practical division of the components for shell and finished installation guarantees safe, easy installation. It is also easy to calculate the required time

- (1) Hot and cold water supply
- (2) Feed pipes showers
- (3) Hansgrohe RainBrain connecting bridge
- (4) Hansgrohe RainBrain functions box
- (5) Hansgrohe RainBrain installation case operating panel
- (6) Hansgrohe RainBrain control panel
- (7) Hansgrohe Raindance Rainfall
- (8) Hansgrohe Fixfit hose connection
- (9) Hansgrohe Raindance Air 100 side showers
- (10) Hansgrohe Raindrain XXL outlet
- (11) Audio amplifier
- (12) Lighting control set
- (13) Distributor box for operating voltage
- (14) Loudspeaker
- (15) Lighting

## Installation 1 function

ShowerSelect® thermostat concealed with Raindance® Select S 120 3jet hand shower

### Components

#### Mixers

- Ⓑ Basic set iBox universal  
# 01800180  
Thermostat ShowerSelect  
for 1 function  
# 15762, -000

#### Alternative:

- Thermostat ShowerSelect S  
# 15744000
- Mixer ShowerSelect  
# 15767000
- Mixer ShowerSelect S  
# 15747000
- Thermostat Ecostat E  
# 15707000
- Thermostat Ecostat S  
# 15757000

#### Showers

- Ⓐ Hand shower Raindance  
Select S 120 3jet  
# 26530, -000  
Porter 'S shower holder  
# 28331, -000  
Isiflex shower hose  
# 28276, -000
- Ⓒ Shower connection Fixfit Square  
# 26455, -000
- Ⓓ Staro 90 waste system  
# 60056, -000

Ceiling

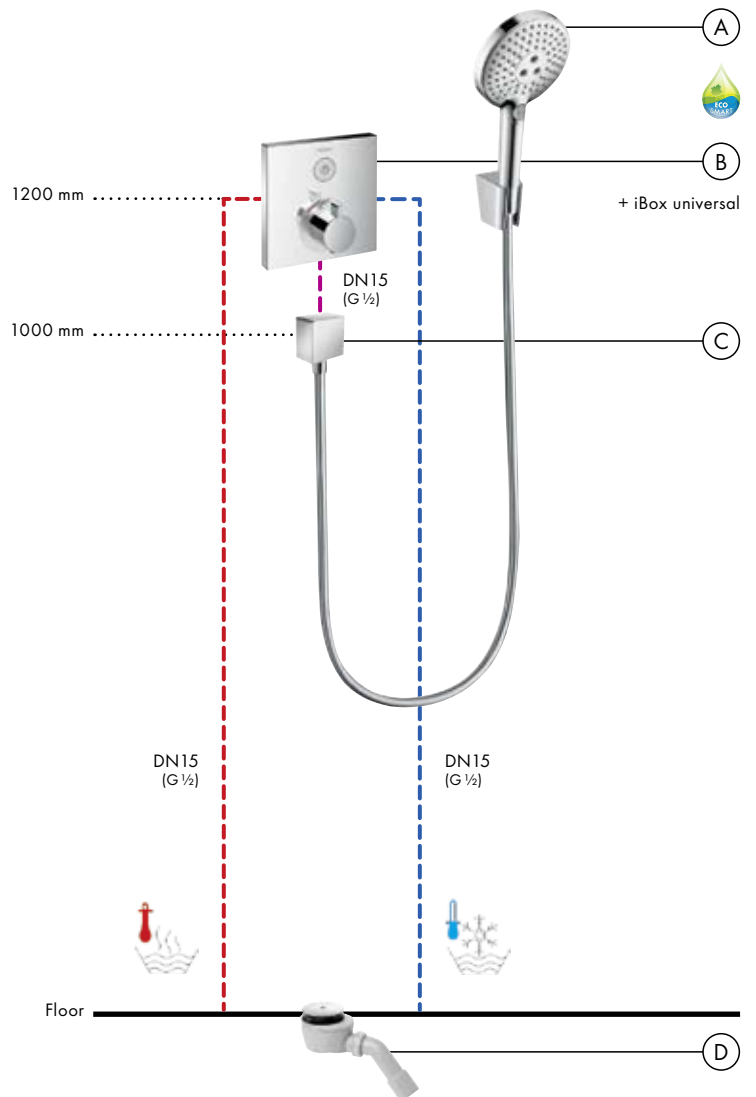

### Flow diagram

Hand shower Raindance Select S 120 3jet  
# 26530, -000

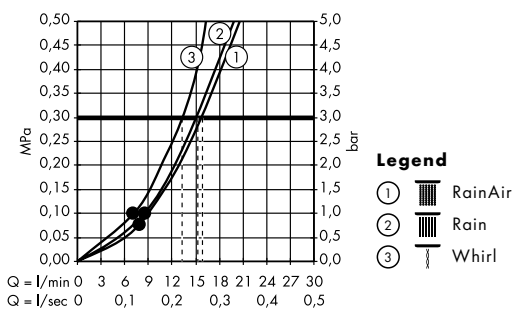

• denotes minimum operating pressure

## Installation 2 functions

ShowerSelect® thermostat concealed with Raindance® Select S 300 2jet overhead shower and Raindance® Select S 120 3jet hand shower

### Components

#### Mixers

- Ⓑ Basic set iBox universal  
# 01800180  
Thermostat ShowerSelect  
for 2 functions  
# 15763, -000

#### Alternative:

- Thermostat ShowerSelect S  
# 15743, -000
- Mixer ShowerSelect  
# 15768, -000
- Mixer ShowerSelect S  
# 15748, -000
- Thermostat Ecostat E  
# 15708, -000
- Thermostat Ecostat S  
# 15758, -000

#### Showers

- Ⓐ Overhead shower Raindance  
Select S 300 2jet  
# 27378, -000
- Ⓒ Hand shower Raindance  
Select S 120 3jet  
# 26530, -000  
Porter 'S shower holder  
# 28331, -000  
Isiflex shower hose  
# 28276, -000
- Ⓓ Shower connection Fixfit Square  
# 26455, -000
- Ⓔ Staro 90 waste system  
# 60056, -000

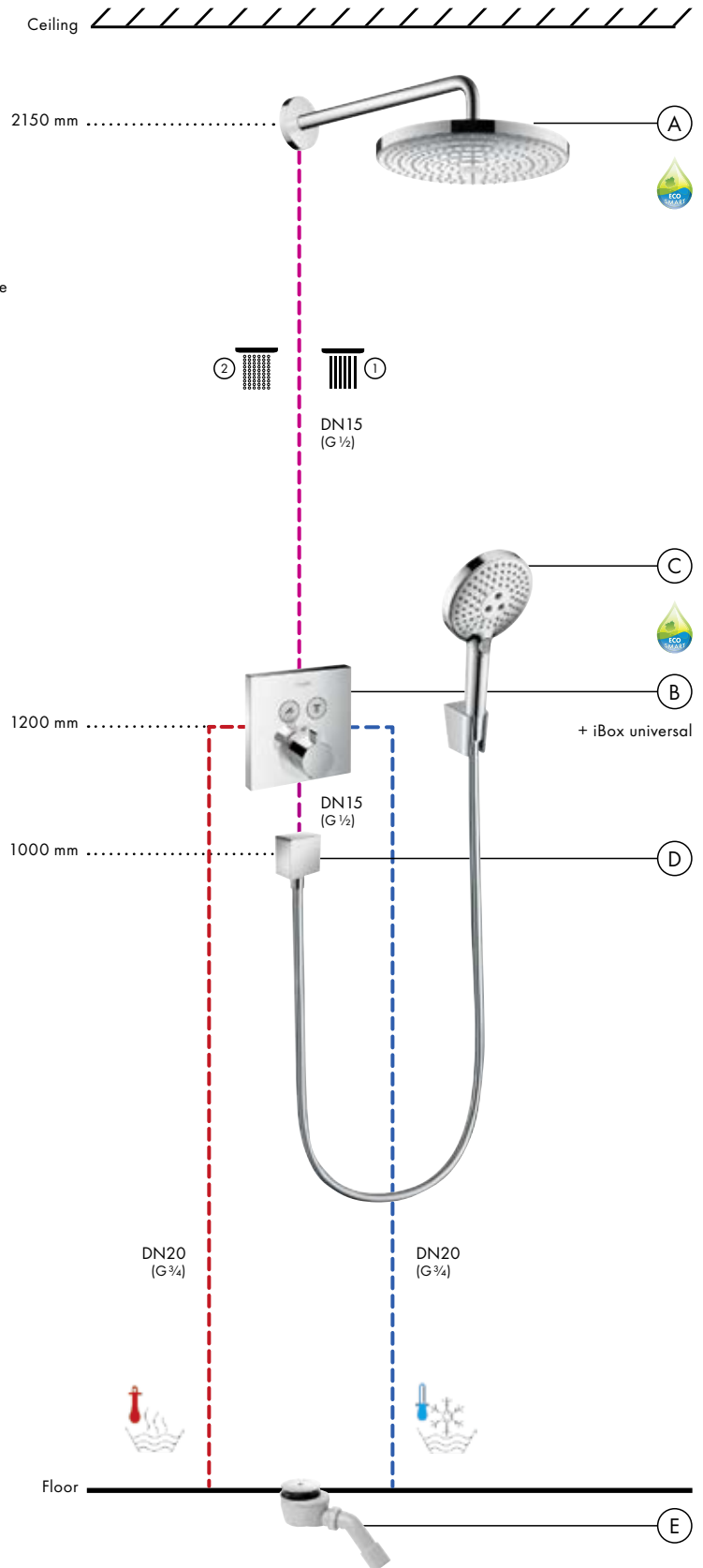

### Flow diagram

Overhead shower Raindance Select S 300 2jet  
# 27378, -000

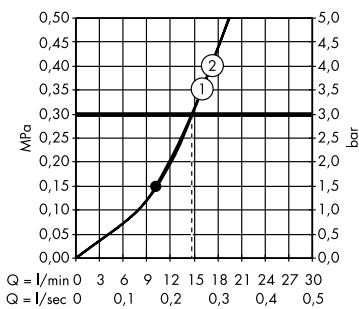

#### Legend

- ① Rain
- ② RainAir

### Flow diagram

Hand shower Raindance Select S 120 3jet  
# 26530, -000

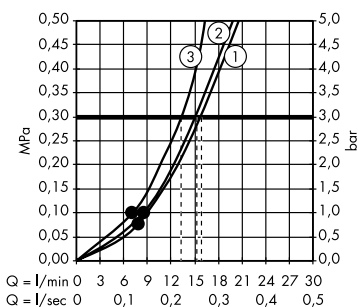

#### Legend

- ① RainAir
- ② Rain
- ③ Whirl

• denotes minimum operating pressure



### Installation 3 functions

ShowerSelect® thermostat concealed with 2 spray overhead shower Raindance® Rainfall® 2jet and Raindance® Select S 120 3jet hand shower

#### Components

##### Mixers

- (C) Basic set iBox universal #01800180  
Valve ShowerSelect for 3 functions #15764, -000
- (D) Basic set iBox universal #01800180  
Highflow Thermostat ShowerSelect #15760, -000

Alternative:  
Valve ShowerSelect S for 3 functions #15745, -000  
Highflow Thermostat ShowerSelect S #15741, -000

##### Showers

- (A) Basic set iBox universal #01800180  
Overhead shower Raindance Rainfall 2jet #28433, -000

Alternative:  
Overhead shower Raindance E 420 Air 2jet #27373, -000

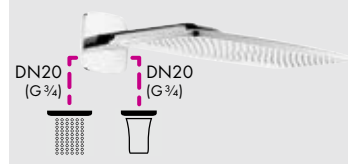

- (B) Hand shower Raindance Select S 120 3jet #26530, -000  
Porter 'S shower holder #28331, -000  
Isiflex shower hose #28276, -000
- (E) Shower connection Fixfit Square #26455, -000
- (F) Raindrain XXL waste system #60067, -000

#### Flow diagram

Overhead shower Raindance Rainfall 2jet #28433, -000

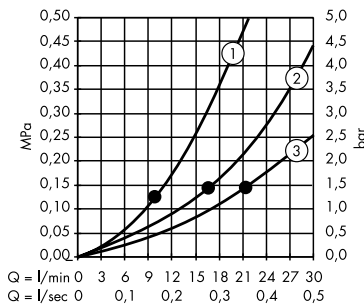

#### Flow diagram

Hand shower Raindance Select S 120 3jet #26530, -000

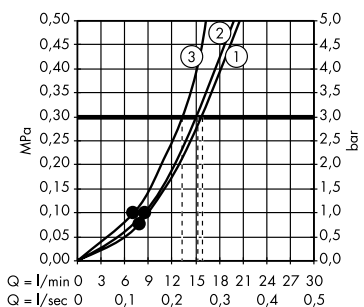

• denotes minimum operating pressure

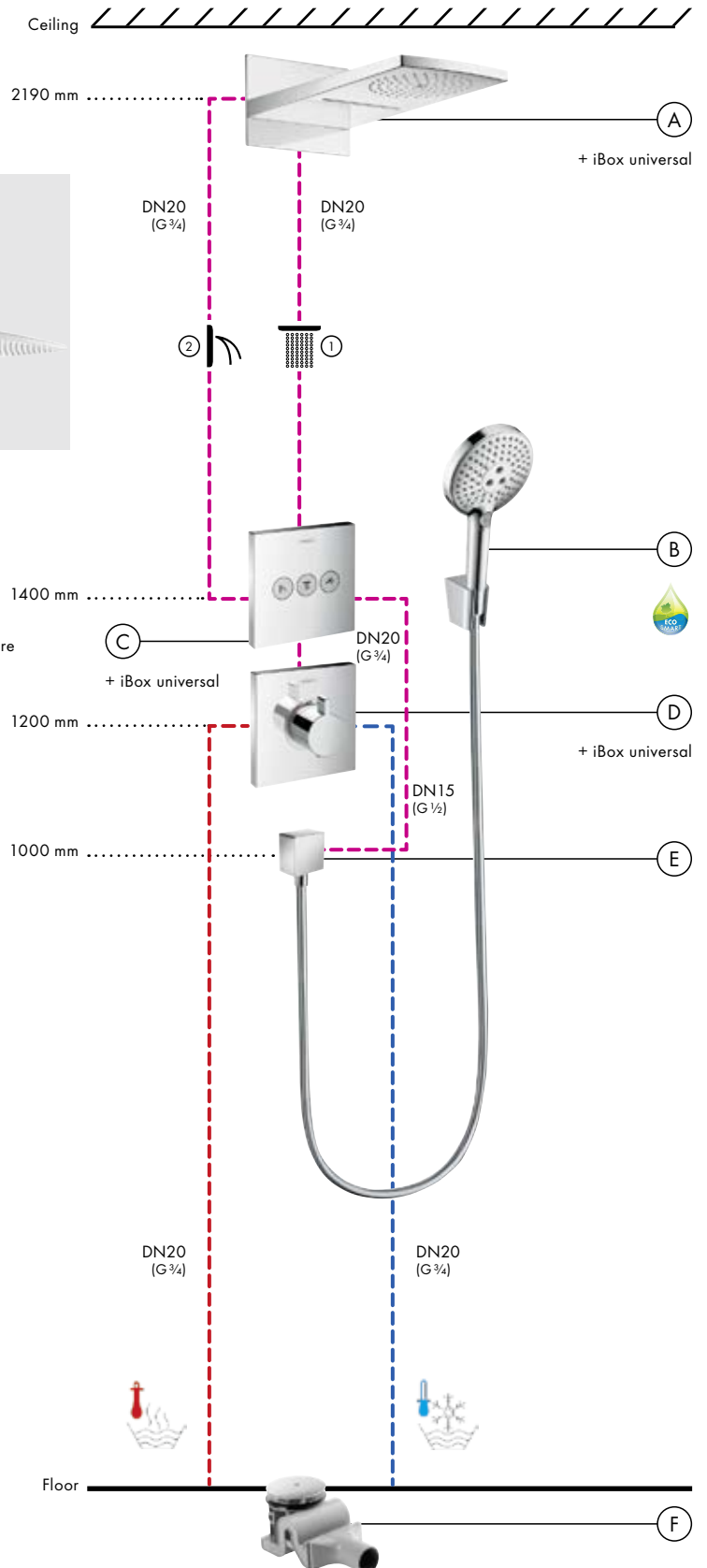

## Installation 3 functions

Ecostat® S thermostat concealed with 2 spray overhead shower Raindance® Rainfall® 2jet and Raindance® Select S 120 3jet hand shower

### Components

#### Mixers

- (C) Trio/Quattro basic set  
# 15981180  
Trio/Quattro S shut-off valve  
# 15932, -000
- (D) Basic set iBox universal  
# 01800180  
Highflow Thermostat Ecostat S  
# 15715, -000
- (E) Shut-off valve basic set  
# 15974180  
Shut-off valve S DN15/DN20  
# 15972, -000

Other alternatives possible.

#### Showers

- (A) Basic set iBox universal  
# 01800180  
Overhead shower Raindance  
Rainfall 2jet  
# 28433, -000

Alternative:  
Overhead shower Raindance  
Select E 300 3jet  
# 26468, -000

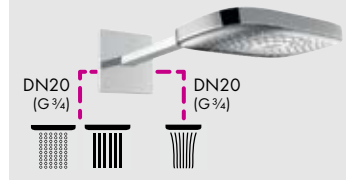

- (B) Hand shower Raindance  
Select S 120 3jet  
# 26530, -000  
Porter 'S shower holder  
# 28331, -000  
Isiflex shower hose  
# 28276, -000
- (F) Shower connection Fixfit S  
# 27453, -000
- (G) Raindrain XXL waste system  
# 60067, -000

### Flow diagram

Overhead shower Raindance Rainfall 2jet  
# 28433, -000

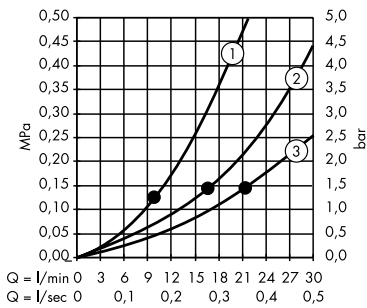

#### Legend

- (1) RainAir
- (2) RainFlow
- (3) RainAir + RainFlow

### Flow diagram

Hand shower Raindance Select S 120 3jet  
# 26530, -000

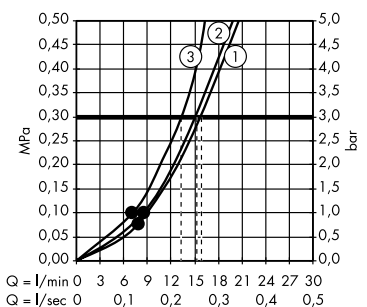

#### Legend

- (1) RainAir
- (2) Rain
- (3) Whirl

• denotes minimum operating pressure

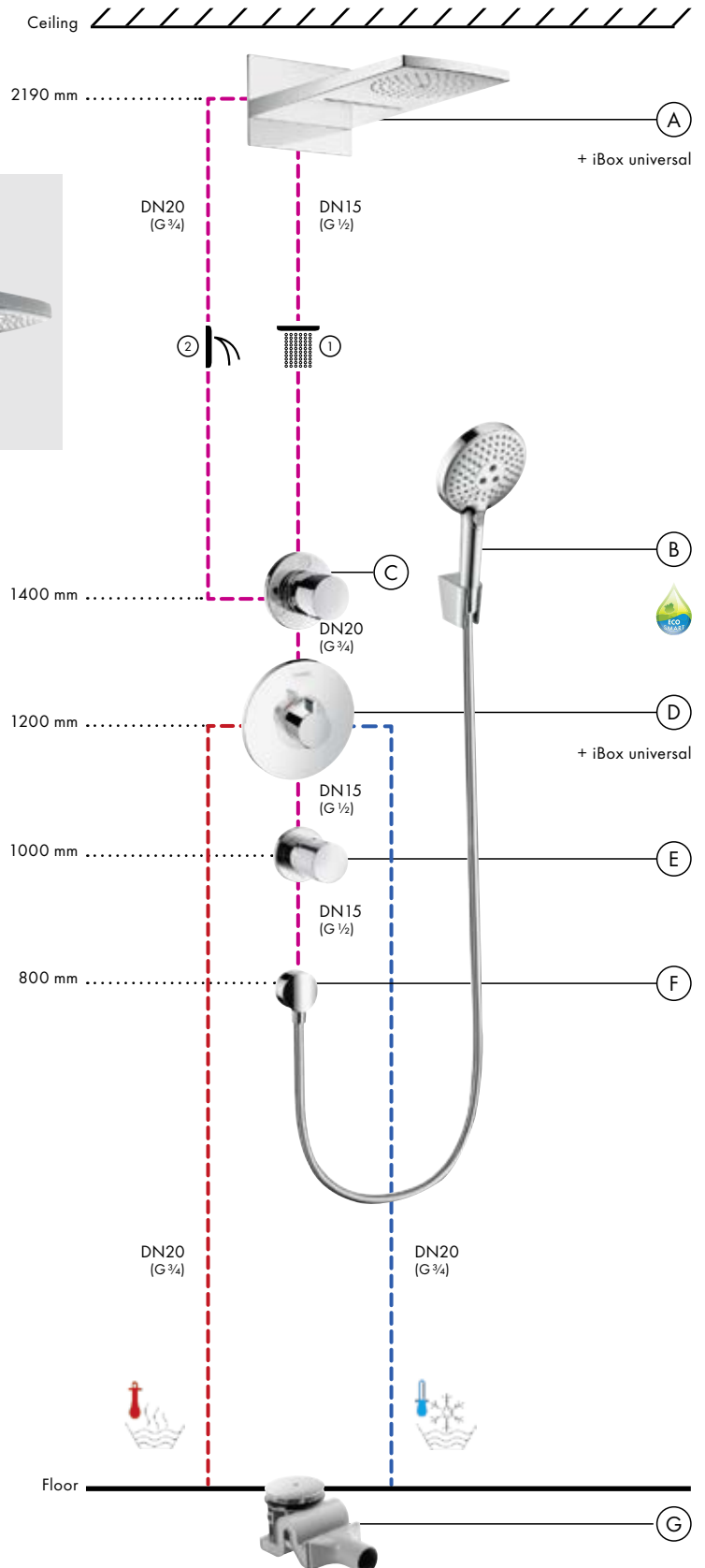

### Installation 4 functions

ShowerSelect® thermostat concealed with 3 spray overhead shower Raindance® Rainfall® 3jet and Raindance® Select S 120 3jet hand shower

**Components**

Mixers

- (C) Basic set iBox universal #01800180  
Valve ShowerSelect for 3 functions #15764, -000
- (D) Basic set iBox universal #01800180  
Highflow Thermostat ShowerSelect #15760, -000

Alternative:  
Valve ShowerSelect S for 3 functions #15745, -000  
Highflow Thermostat ShowerSelect S #15742, -000

Showers

- (A) Basic set iBox universal #01800180  
Overhead shower Raindance Rainfall 240 3jet #28411, -000
- (B) Hand shower Raindance Select S 120 3jet #26530, -000  
Porter 'S' shower holder #28331, -000  
Isiflex shower hose #28276, -000
- (E) Shower connection Fixfit Square #26455, -000
- (F) Raindrain XXL waste system #60067, -000

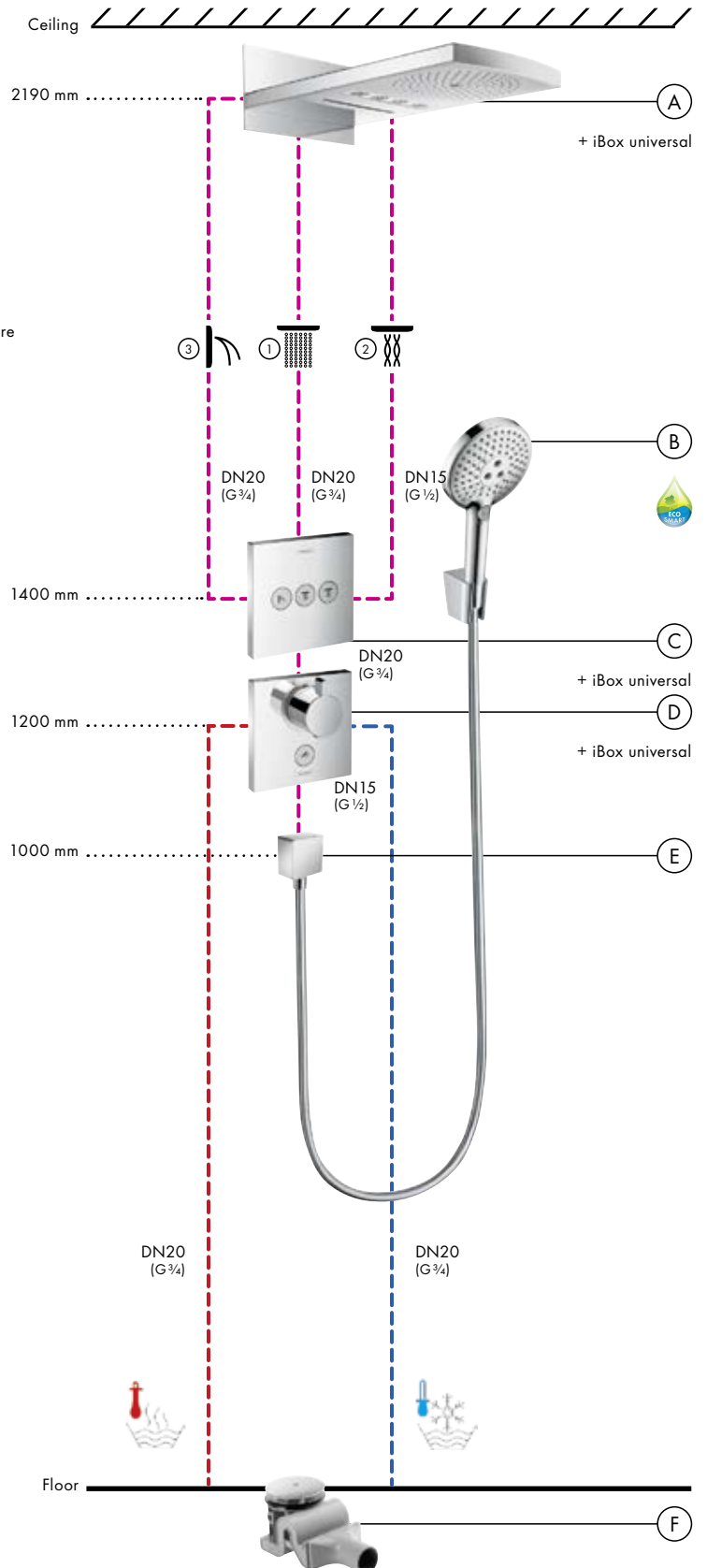

**Flow diagram**

Overhead shower Raindance Rainfall 3jet #28411, -000

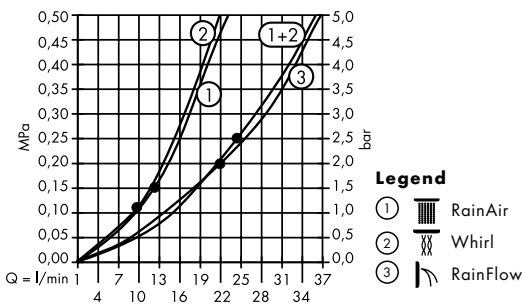

**Flow diagram**

Hand shower Raindance Select S 120 3jet #26530, -000

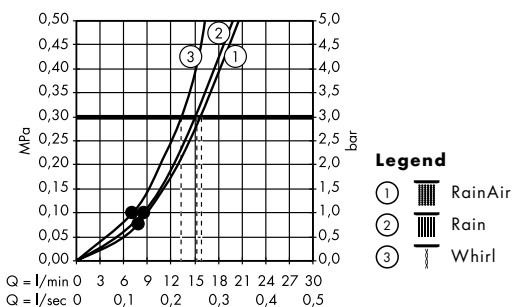

• denotes minimum operating pressure

## Installation 4 functions

Ecostat® S thermostat concealed with 3 spray overhead shower Raindance® Rainfall® 3jet and Raindance® Select S 120 3jet hand shower

### Components

#### Mixers

- (C) Quattro basic set  
# 15930180  
Trio/Quattro S shut-off valve  
# 15932, -000
- (D) Shut-off valve basic set  
# 15970180  
Shut-off valve S DN15/DN20  
# 15972, -000
- (E) Basic set iBox universal  
# 01800180  
Highflow Thermostat Ecostat S  
# 15715, -000
- (F) Shut-off valve basic set  
# 15974180  
Shut-off valve S DN15/DN20  
# 15972, -000

Other alternatives possible.

#### Showers

- (A) Basic set iBox universal  
# 01800180  
Overhead shower Raindance  
Rainfall 240 3jet  
# 28411, -000
- (B) Hand shower Raindance  
Select S 120 3jet  
# 26530, -000  
Porter 'S shower holder  
# 28331, -000  
Isiflex shower hose  
# 28276, -000
- (G) Shower connection Fixfit S  
# 27453, -000
- (H) Raindrain XXL waste system  
# 60067, -000

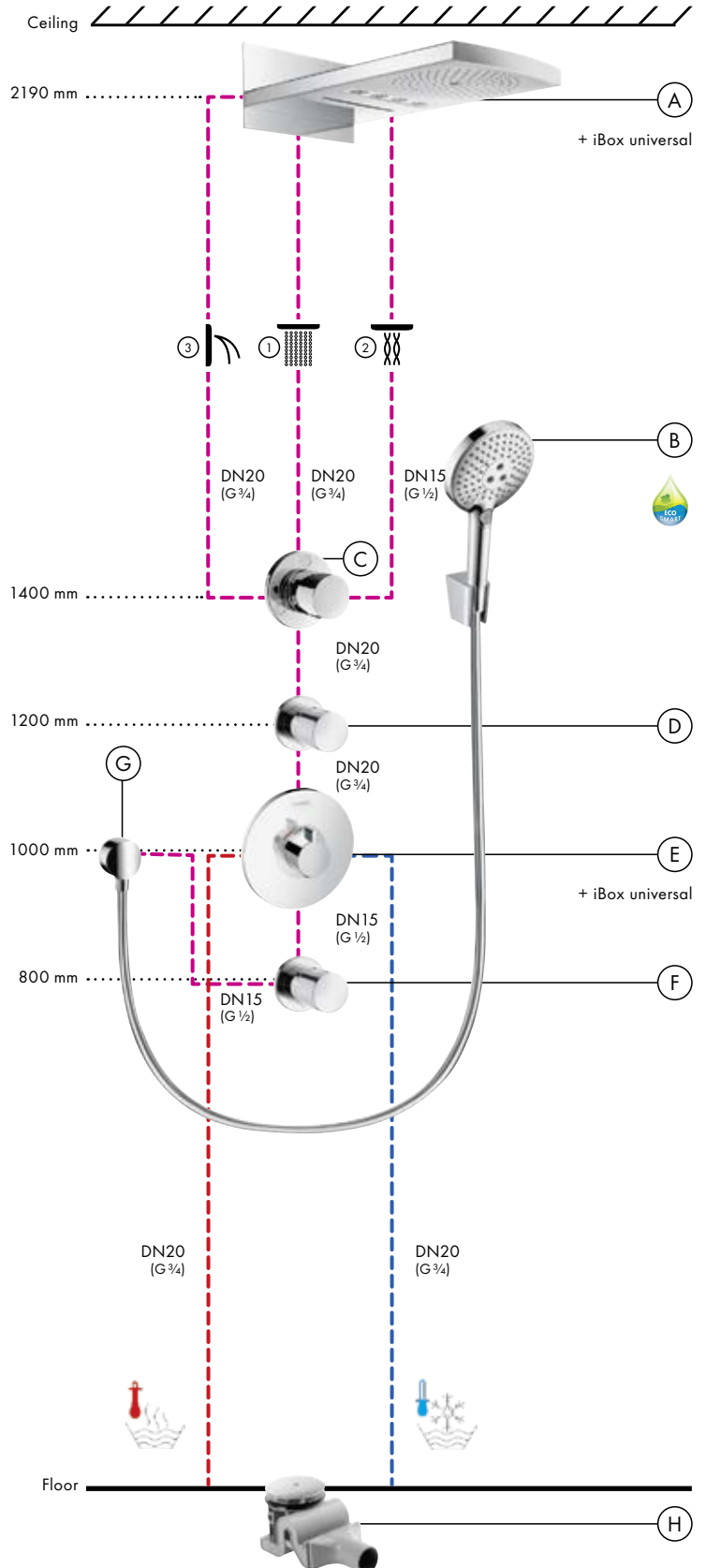

### Flow diagram

Overhead shower Raindance Rainfall 3jet  
# 28411, -000

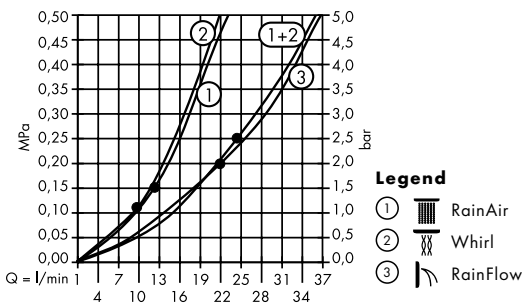

### Flow diagram

Hand shower Raindance Select S 120 3jet  
# 26530, -000

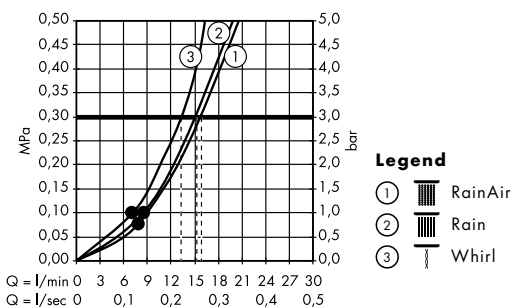

• denotes minimum operating pressure

# BATH MIXERS

---

**The right product for every taste:**

Basin mixers | Bidet mixers

Bath and shower mixers | Accessories



Hansgrohe bathroom mixers

# Stylish choices for an individual dream bathroom

The Hansgrohe mixers line caters to every style and taste, from modern to classic, from geometrical to rounded. This wide range

gives your customers the freedom to find their personal style through the whole bathroom. Besides the wash basin solutions, there are also

matching bath and shower mixers and accessories.

## PuraVida®



Elegant mixers for more sensuality in the bathroom. From page 140.

## Metris®/Metris® S



Large areas add a timeless elegance to the bathroom. From page 146.

## Talis® Select S/Talis® S

**NEW**

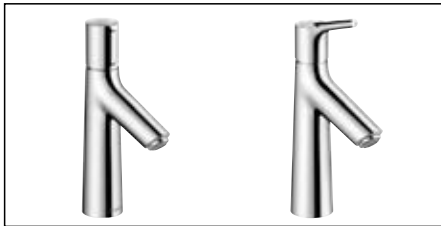

A new naturalness that also appeals for operation at the touch of a button. From page 152.

## Talis®/Talis® S



Flowing forms create a modern flair. From page 156.

## Talis® Select E/Talis® E

**NEW**



Pioneering style that also sets standards with operation at the touch of a button. From page 158.

## Focus®



Dynamic design emanates freshness and lightness. From page 162.

## Logis®

**NEW**



Soft silhouette for a homelike atmosphere. From page 164.

## Metris® Classic



Decorative lines for an elevated ambience. From page 168.

## Talis® Classic



Harmonious elegance for tasteful bathrooms. From page 170.

## Logis® Classic

**NEW**



Classic charisma that elegantly completes the bathroom. From page 172.

ComfortZone: Mixer wash basin combinations



## Something to suit every customer

Whether free standing, wall-hanging, surface-mounted or built-in basins, the perfected Hansgrohe portfolio with a range of heights provides the right solution for every one of your needs. High risers and high, swivelling mixers can be used to fill even large wash bowls or wash hair with ease. Mid range mixer heights allow adequate freedom of movement

for daily routines. Low mixers are a must, too, e.g. as highlights in the guest toilet or cloakroom. Optimal functionality is not the only consideration, the look is also decisive in the choice of mixer and washbasin combinations. To compare these to the best possible effect, you can make use of the Hansgrohe ComfortZone configurator available on the

internet. You can then design the washbasin with the greatest of ease. You can even show your customers in advance how each of the mixer lines blend perfectly into their environment. Visit [www.hansgrohe-int.com/configurator](http://www.hansgrohe-int.com/configurator)

### Avantgarde PuraVida®

#### Free standing basin



Example design with **PuraVida® 240**

#### Wall-hanging basin



Example design with **PuraVida® 200**

### Modern

Metris®/Metris® S  
Talis® Select S/Talis® S  
Talis®/Talis® S  
Talis® Select E/Talis® E  
Focus®  
Logis®



Example design with **Metris® 260**



Example design with **Metris® 230**

### Classic

Metris® Classic  
Talis® Classic  
Logis® Classic



Example design with **Metris® Classic 250**



**ComfortZone:** Whether you need more freedom of movement when washing your hands, washing your hair, or filling large containers; the taller the mixer, the more flexibility you have in your daily dealings with water. We call this area between the mixer and the basin the ComfortZone. For more comfort. For more space. For every day.

**Talis® swivel spout:**

This practical spout creates an arc shaped jet, boosting the personal ComfortZone in moments.

( )

**Surface-mounted basin**

**Built-in basin**

**Hand wash basin**



Example design with **Metris® 200**



Example design with **Metris® 110**



Example design with **Metris® 100**



Example design with **Metris® Classic 100**



Example design with **Metris® Classic 100**



Example design with **Metris® Classic 100**



ComfortZone test



# The right mixer for every washbasin

The taller the mixer, the larger the usable space. If a wash basin and mixer are not properly tuned to each other, the user suffers annoying splashes. As a measure to

eliminate this eventuality from the outset, Hansgrohe has developed the ComfortZone test. Under highly realistic conditions, Hansgrohe mixers are tested for their

compatibility with the wash basins of market leading manufacturers. The tests were conducted on the following five wash basin configurations.

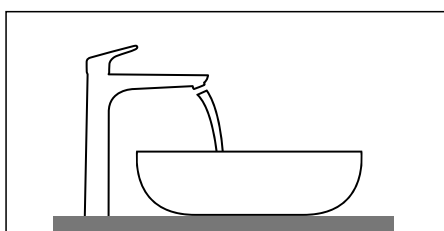

Mixer behind free standing surface-mounted basin or behind wash bowl.

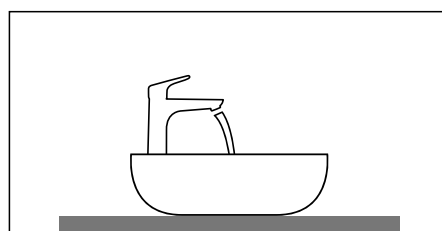

Wash bowl with surface-mounted mixer.

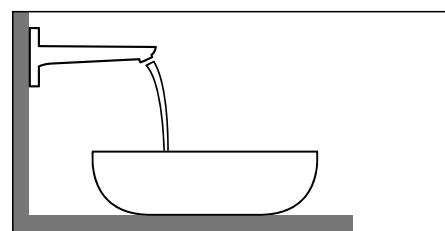

Wash bowl with wall mixer.

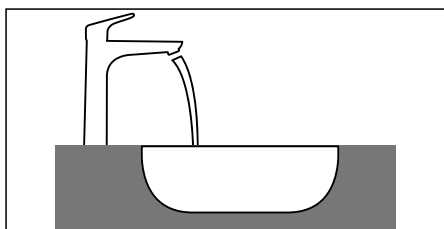

Mixer for built-in basin.

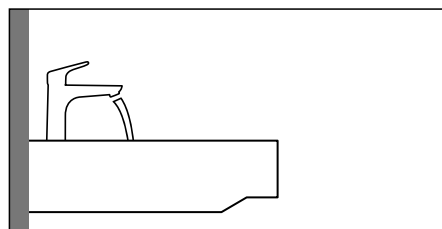

Wall-hanging wash basin with surface-mounted mixer.



Feel confident of your recommendation when you see: the Hansgrohe ComfortZone test seal.



## How the ComfortZone test works

### 1. Free space test

Is there enough of a gap in the combination of mixer and wash basin? A test sphere is positioned between the mixer and wash basin to check how easy and comfortable it is to wash the hands.

### 2. Spray test

Is there any splashing when the mixer is turned on? The mixer is opened and closed several times under different water pressures. Between jets, the splashes are analysed and the wash basin rubbed dry.

### 3. Practical test

Is there any splashing when washing the hands? A standardised hand model is passed under the water jet and the splashes outside of the basin analysed.

## Free PDF: the results from over 9000 combinations

Utilise our knowhow from thousands of tests: We provide you, as a professional partner, exclusive access to all findings of these test series. This overview of all tested mixer and wash basin combinations provides a sound

basis for your recommendations. The PDF files with all the test findings are available free of charge at

<http://pro.hansgrohe-int.com/comfortzone-test>

**hansgrohe**

**Which Hansgrohe mixer suits which basin?**

Hansgrohe ComfortZone mixer with product code

Wash basin with product code

	450	500 x 250	485 x 315	395 x 465	550 x 465	850 x 490	1050 x 490	1250 x 490	600 x 470	800 x 470	1000 x 470	1200 x 470	500 x 380	600 x 380									
<b>Metris</b>	# 070215.00	# 070350.28	# 070350.29	# 070350.30	# 033048.00	# 033048.22	# 040750.00	# 031555.00	# 032985.00	# 032910.00	# 032912.00	# 045460.90	# 045460.37	# 045460.41	# 045480.00	# 045480.27	# 045410.27	# 045410.28	# 045412.00	# 045412.40	# 045350.00	# 045350.00	
<b>Metris 100</b>	# 31088000	✓	✓	✓																			
	# 31166000	✓	✓	✓																			
<b>Metris 110</b>	# 31080000	✓	✓	✓	✓ b1	✓	✓	✓	✓	✓	✓	✓	✓	✓	✓	✓	✓	✓	✓	✓	✓	✓	✓
	# 31121000	✓	✓	✓	✓ b1	✓	✓	✓	✓	✓	✓	✓	✓	✓	✓	✓	✓	✓	✓	✓	✓	✓	✓
	# 31084000	✓	✓	✓	✓ b1	✓	✓	✓	✓	✓	✓	✓	✓	✓	✓	✓	✓	✓	✓	✓	✓	✓	✓
<b>Metris 200</b>	# 31183000			✓ b1	✓	✓	✓	✓	✓	✓	✓	✓	✓	✓	✓	✓	✓	✓	✓	✓	✓	✓	✓
	# 31185000			✓ b1	✓	✓	✓	✓	✓	✓	✓	✓	✓	✓	✓	✓	✓	✓	✓	✓	✓	✓	✓
<b>Metris 250</b>	# 31087000			✓ b1	✓	✓	✓	✓	✓	✓	✓	✓	✓	✓	✓	✓	✓	✓	✓	✓	✓	✓	✓
	# 31187000			✓ b1	✓	✓	✓	✓	✓	✓	✓	✓	✓	✓	✓	✓	✓	✓	✓	✓	✓	✓	✓
	# 31081000			✓ b1	✓	✓	✓	✓	✓	✓	✓	✓	✓	✓	✓	✓	✓	✓	✓	✓	✓	✓	✓
<b>Metris 200</b>	# 31082000			✓ b2	✓	✓	✓	✓	✓	✓	✓	✓	✓	✓	✓	✓	✓	✓	✓	✓	✓	✓	✓
	# 31184000			✓ b2	✓	✓	✓	✓	✓	✓	✓	✓	✓	✓	✓	✓	✓	✓	✓	✓	✓	✓	✓
<b>Metris 165 mm</b>	# 31085000			✓ d1																	✓ d1	✓ d2	✓ d3
<b>Metris 225 mm</b>	# 31086000			✓ d1									✓ c1	✓ c1	✓ c1	✓ c1	✓ c1	✓ c1	✓ c1	✓ c1	✓ c1	✓ c1	✓ c1

Suitable combinations

Mounting dimensions for different installations



### Advantages and benefits

- Reliable test procedure on the wash basins of leading manufacturers, fitted in accordance with the instructions
- Recommendations from over 9000 tested mixer wash basin combinations available online for planning – constantly expanded and updated
- The certainty that wash basin and mixer harmonise – without annoying splashes

Find out more in the “ComfortZone Test” discussion and at <http://pro.hansgrohe-int.com/comfortzone-test>

Innovative mixer technologies by Hansgrohe

# More technology and comfort for you and your customers



## Advantages and benefits

- EcoSmart technology limits flow to 5 l/min, saving water and energy
- QuickClean for easy cleaning and long-lasting mixers
- AirPower for a full and soft water jet
- Compliance with the German drinking water regulations TrinkwV of 2013
- Various designs and styles - the right mixer for every taste
- Five year warranty

Find out more at <http://pro.hansgrohe-int.com>



## Select: easy operation at the touch of a button

A button instead of a lever – this is the new shape of comfort at the basin. Thanks to the Select button, a gentle touch is all it takes to get the water flowing. Another touch, and it

stops. This makes daily routines such as shaving, washing hair and brushing teeth much easier. For people of any age. The mechanical Select button satisfies any requirements: long-

term tests have confirmed its quality and durability.



### Advantages and benefits

- Easy operation – suitable for all ages
- Temperature can be pre-set
- Can also be operated with an arm or elbow

## AirPower: for water in all of its fullness

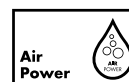

### Advantages and benefits

- Fuller, lighter, softer drops for a pleasant water jet
- Less risk of splashing
- High efficiency contributes towards reduced water consumption

**AirPower** draws air in through the outlet and then it is used to enrich the flowing water. The water jet becomes fuller, lighter and softer.

## QuickClean: rubbing away limescale in moments



### Advantages and benefits

- Fast and easy cleaning
- Long lifetime and functionality

**QuickClean** stands for flexible silicone inserts on the aerators that are simply rubbed with a finger to remove dirt and limescale. This ensures the products remain functional and last longer.



## EcoSmart: water and energy savings

Thanks to EcoSmart technology, the water consumed by all Hansgrohe basin mixers could be reduced to 5 l/min from the customary 13 l/min. This also saves energy because less

water needs to be heated. All this was made possible with air injection and the integrated EcoSmart system. This special efficiency was confirmed with the Bathroom Manufacturers

Association **Water Efficiency Label** Scheme. EcoSmart is not only about potential savings, but also the protection of our environment.



<b>WELL</b> Home Water Efficiency Label	
Manufacturer:	Hansgrohe SE
Product category:	Wash-basin valve
Type:	Single-lever valve
Model:	Hansgrohe Metris 110
Registration number:	WA1000320110009
<b>Water Efficiency Criteria</b>	
Flow rate > 6.0 l/min ≤ 9.0 l/min	*
Controlled flow rate ≥ 4.0 l/min ≤ 6.0 l/min	**
Flow-independent temperature setting	*
Temperature limit / Cold water valve	**
<small>Information about use and installation: <a href="http://www.well-online.eu">www.well-online.eu</a>                  A Label of EU-United Values                  European Valve Manufacturers Association</small>	

l/min  
**5.0**

### Example calculation of annual savings with EcoSmart basin mixer\*:

Water approx 61,880 l  
 CO<sub>2</sub> approx 413 kg  
 Costs approx 549 € for water and energy

\* Compared with a basin mixer with 13.5 l/min. Average values for a family of four in Germany in 2014.

All products with WELL certificates are specially marked in the catalogue



### Advantages and benefits

- Water consumption as low as 5 l/min
- Precision O ring for a constant flow even under fluctuating water pressures
- Full, sparkling water jet thanks to air enrichment
- Reduced consumption for less energy needs and hence less CO<sub>2</sub> emissions
- Lower water and energy consumption for double efficiency
- WELL quality mark as certification basis in projects



How much water can be saved is calculated by the savings calculator at:  
<http://pro.hansgrohe-int.com/savings-calculator>

l/min  
**3.5**

## LowFlow: mixers for minimal flow rates

Especially in projects, water and energy savings are an important factor for the certification of buildings, e.g. under Part G, LEED or BREEAM. For this purpose, Hansgrohe has developed special cartridges that minimise the flow rate through its mixers. These LowFlow cartridges have a restricted opening angle and special spray formers. Result: a flow rate of only 3.5 l/min.



### Advantages and benefits

- Savings in water and energy
- Certification advantages especially for projects
- Precise temperature setting despite low flow rate

## CoolStart: now saving energy is even easier

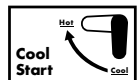

Whereas the central position on standard mixers immediately activates mixed water (both hot and cold), with CoolStart mixers only cold water runs through. The pipe system is therefore not filled unnecessarily with hot water. Hot water is not added until the lever is moved to the left. This helps to reduce the energy needs and hence CO<sub>2</sub> emissions as well. This goes easy on the environment – and your pocket as well.



CoolStart technology is available in the following mixers:



**Metris**® 110



**Talis**® 80  
**Talis**® S 80  
**Talis**® E 80



**Focus**® 100  
**Focus**® 70



**Logis**® 100  
**Logis**® 70

**CoolStart:** Hot water runs only when it is actually needed.





















### Advantages and benefits

- At the basic setting, only cold water flows without the need to draw on heated water
- Potential for water, energy and financial savings
- Special user ergonomics (the lever need only be moved to the left for hot water)

Hansgrohe bathroom mixers

# The bathroom mixer lines at a glance

























	PuraVida®	Metris®	Metris® S	Metris® Classic	NEW Talis® Select S/Talis® S
Spout height ↑	 <b>PuraVida® 240</b>	 <b>Metris® 260</b>	 <b>Metris® S</b>	 <b>Metris® Classic 250</b>	
		 <b>Metris® 230</b>	 <b>Metris® S</b>		 <b>Talis® S 210</b>
	 <b>PuraVida® 200</b>	 <b>Metris® 200</b>	 <b>Metris® S</b> <span style="border: 1px solid black; padding: 2px;">NEW</span>		 <b>Talis® Select S 190</b>
	 <b>PuraVida® 110</b>	 <b>Metris® 110</b>	 <b>Metris® S</b>		 <b>Talis® Select S 100</b>
	 <b>PuraVida® 100</b>	 <b>Metris® 100</b>		 <b>Metris® Classic 100</b>	 <b>Talis® Select S 80</b>
	More details on PuraVida bathroom mixers can be found on pages 140 onwards.	More details on Metris bathroom mixers can be found on pages 146 onwards.		More details on Metris Classic bathroom mixers can be found on pages 168 onwards.	More details on Talis bathroom mixers can be found on pages 152 onwards.

**How to use the overview in your sales presentation**

The higher a product is positioned, the greater its ComfortZone. The products are arranged in ranges extending to the right.























































Hansgrohe bathroom mixers

# The bathroom mixer range at a glance

























				<b>NEW</b>
		<b>PuraVida®</b>	<b>Metris®</b>	<b>Talis® Select S</b>
<b>Basin</b>				
	Pillar tap	 # 15132, -000, -400	 # 31166, -000	
<b>Single lever basin mixer</b>	for small wash basins	 # 15075, -000, -400	 # 31088, -000	
	with pop-up waste set	 # 15074, -000, -400	 # 31080, -000	 # 72040, -000
	with Push-Open waste	 # 15070, -000, -400		
	without waste set		 # 31084, -000	 # 72041, -000
	for open water heaters		 # 31074, -000	
<b>Taller models</b>	with pop-up waste set	 # 15081, -000, -400	 # 31183, -000	 # 72042, -000
	without waste set			 # 72043, -000
<b>Single lever basin mixer with swivel spout</b>	with pop-up waste set		 # 31087, -000	
	with Push-Open waste		 # 31187, -000	
	without waste set		 # 31081, -000	
<b>Single lever basin mixers for wash bowls (high risers)</b>	with pop-up waste set	 # 15072, -000, -400	 # 31082, -000	 # 72044, -000
	without waste set		 # 31184, -000	 # 72045, -000
<b>3-hole basin mixer</b>		 # 15073, -000, -400	 # 31083, -000	

















































This excerpt from the Hansgrohe product range is to help your customers find the right solution for each and every one of their requirements. The overview presents possible solutions within the Hansgrohe core range.

<b>NEW</b> Talis® S	<b>NEW</b> Talis® Select E	<b>NEW</b> Talis® E	Talis®	Focus®	Logis®
 #72017,-000		 #71706,-000	 #32130,-000	 #31130,-000	 #71120,-000
 #72010,-000		 #71700,-000	 #32040,-000	 #31730,-000	 #71070,-000
 #72011,-000		 #71701,-000		 #31604,-000	 #71077,-000
 #72012,-000		 #71702,-000	 #32041,-000	 #31733,-000	 #71071,-000
 #72016,-000		 #71707,-000		 #31132,-000	 #71074,-000
 #72020,-000	 #71750,-000	 #71710,-000	 #32052,-000	 #31607,-000	 #71100,-000
 #72021,-000	 #71751,-000	 #71712,-000		 #31517,-000	 #71101,-000
 #72105,-000			 #32084,-000	 #31609,-000	 #71130,-000
			 #32082,-000		
				 #31519,-000	 #71131,-000
 #72031,-000	 #71752,-000	 #71716,-000		 #31608,-000	 #71090,-000
 #72032,-000	 #71753,-000	 #71717,-000		 #31518,-000	 #71091,-000
 #72130,-000		 #71733,-000	 #32310,-000		 #71133,-000

**NEW**

		<b>PuraVida®</b>	<b>Metris®</b>	<b>Talis® Select S</b>
<b>Basin</b>				
<b>Single lever basin mixer</b>	Wall installation 165 mm	 # 15084, -000, -400	 # 31085, -000	
	Wall installation 225 mm	 # 15085, -000, -400	 # 31086, -000	
<b>Electronic mixer</b>				
		 # 15170, -000, -400	 # 31100, -000	
<b>Bidet</b>				
<b>Single lever bidet mixer</b>		 # 15270, -000, -400	 # 31280, -000	 # 72202, -000
<b>Bath</b>				
<b>Single lever bath mixer</b>	Exposed	 # 15472, -000, -400	 # 31480, -000	
	Concealed	 # 15445, -000, -400 # 15447, -000, -400	 # 31487, -000 # 31493, -000 # 31454, -000 # 31451, -000	
	Floor standing	 # 15473, -000, -400	 # 31471, -000	
<b>3-hole rim-mounted mixer</b>				
<b>3-hole rim-mounted mixer</b>		 # 15432, -000, -400	 # 31190, -000	
<b>4-hole rim-mounted mixer</b>		 # 15446, -000, -400	 # 31442, -000	
<b>Bath filler</b>		 # 15412, -000, -400	 # 31494, -000	
<b>Shower</b>				
<b>Single lever shower mixer</b>	Exposed	 # 15672, -000, -400	 # 31680, -000	
	Concealed	 # 15665, -000, -400	 # 31685, -000 # 31456, -000	

<b>NEW</b> Talis® S	<b>NEW</b> Talis® Select E	<b>NEW</b> Talis® E	Talis®	Focus®	Logis®
 #72110, -000		 #71732, -000	 #31618, -000		 195 mm #71220, -000
 #72111, -000		 #71134, -000	 #31611, -000		
			 #32110, -000	 #31171, -000	
 #72200, -000		 #71720, -000	 #32240, -000	 #31920, -000	 #71200, -000 #71204, -000
 #72400, -000		 #71740, -000	 #32440, -000	 #31940, -000	 #71400, -000
 #72405, -000 #72406, -000		 #71745, -000 #71474, -000	 #32475, -000 #32477, -000	 #31945, -000 #31946, -000	 #71405, -000 #71407, -000
 #72412, -000					
 #72415, -000		 #71747, -000			
 #72416, -000		 #71730, -000			 #71310, -000
 #72418, -000		 #71748, -000			
 #72410, -000		 #71410, -000	 #13414, -000	 #13414, -000	 #71410, -000
 #72600, -000		 #71760, -000	 #32640, -000	 #31960, -000	 #71600, -000
 #72605, -000		 #71765, -000	 #32675, -000	 #31965, -000	 #71605, -000

**NEW**

**Talis®/Talis® S**



**Talis® 250**



**Talis® 210 Talis® S**



**Talis® 150**



**Talis® 80 Talis® S**

**Talis® Select E/Talis® E**



**Talis® Select E 240 Talis® E 240**



**Talis® Select E 110 Talis® E 110**



**Talis® E 80**

**Talis® Classic**



**Talis® Classic 230**



**Talis® Classic 80 Talis® Classic Natural 90**

More details on Talis Classic bathroom mixers can be found on pages 170 onwards.

**Focus®**



**Focus® 240**



**Focus® 190**



**Focus® 100**



**Focus® 70**

More details on Focus bathroom mixers can be found on pages 162 onwards.

**Logis®**



**Logis® 210**



**Logis® 190**



**Logis® 100**



**Logis® 70**

More details on Logis bathroom mixers can be found on pages 164 onwards.

PuraVida®

# Sensuous poetry of purity and clarity



**PuraVida® 110**



**Attractive:** PuraVida emanates a special elegance and integrates perfectly in the bathroom, harmonising with white ceramics.



**Complete in itself:** Here pure elegance can be seen in all of the details. Moreover, the overhead shower is ergonomically shaped to completely cover the user's shoulders.



**Emotionally appealing:** The DualFinish surface unites white and chrome in a harmony of quality.



## Advantages and benefits

- Breadth of range to enable complete, coordinated bathroom design
- Sculptured look from the harmonious unity of body and spout
- Flat pin handle with joystick cartridge
- Visible quality in the precise contoured lines
- Clear laminar jet and adjustable spray angle
- DualFinish surface with precise edges between chrome and white
- Scratch resistant powder coating

## Basin/bidet



**PuraVida® 240**  
Single lever basin mixer  
with Push-Open waste  
# 15072, -000, -400 Hose  
length 900 mm  
# 15066, -000, -400 Hose  
length 600 mm



**PuraVida® 200**  
Single lever basin mixer  
with Push-Open waste  
# 15081, -000, -400



**PuraVida® 110**  
Single lever basin mixer  
# 15070, -000, -400  
with Push-Open waste  
# 15074, -000, -400  
with pop-up waste set



**PuraVida® 100**  
Single lever basin mixer  
for small wash basin  
with Push-Open waste  
# 15075, -000, -400



More freedom of movement at the wash basin for greater comfort



**PuraVida® 100**  
Pillar top for small wash basin  
# 15132, -000, -400



**PuraVida®**  
Electronic basin mixer with  
temperature control  
# 15170, -000, -400 Battery  
operation  
# 15172, -000, -400 Mains  
connection 230 V



**PuraVida® 100**  
3-hole basin mixer with fixed  
spout  
# 15073, -000, -400 without  
waste set  
# 15063, -000, -400 with  
pop-up waste set



**PuraVida®**  
Single lever basin mixer for  
wall installation  
# 15085, -000, -400 225 mm  
Basic set for concealed  
installation  
# 13622180



**PuraVida®**  
Single lever basin mixer for  
wall installation  
# 15084, -000, -400 165 mm  
Basic set for concealed  
installation  
# 13622180



**PuraVida®**  
Single lever bidet mixer  
with pop-up waste set  
# 15270, -000, -400



Surface chrome (-000)



Surface white/ chrome (-400)



All products are shown with white/chrome (-400) surfaces.

**PuraVida®**

**Bath**



**PuraVida®**  
3-hole rim-mounted mixer  
# 15432, -000, -400  
Basic set for concealed installation  
# 13437180



**PuraVida®**  
4-hole bath mixer  
for rim-mounted installation  
# 15446, -000, -400  
Basic set for concealed installation  
# 13444180



**PuraVida®**  
2-hole rim-mounted thermostat  
# 15474, -000, -400  
Basic set for concealed installation  
# 13550180

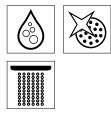
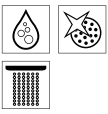

- No broken tiles thanks to pre-assembled basic set
- Secuflex Box protects the shower hose behind the bath
- Shower hose does not catch when used
- Easy servicing thanks to completely sealed system which can be accessed from above



**PuraVida®**  
Single lever bath mixer,  
floor standing, with PuraVida  
120 ljet baton hand shower  
# 15473, -000, -400  
Basic set for concealed installation  
# 10452180



**PuraVida®**  
Single lever bath mixer  
exposed  
# 15472, -000, -400



**PuraVida®**  
Single lever bath mixer  
concealed  
# 15445, -000, -400  
# 15447, -000, -400 with  
safety combination



**PuraVida®**  
Bath filler  
exposed  
# 15412, -000, -400

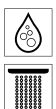

## Shower



**PuraVida®**  
Single lever shower mixer  
exposed  
# 15672, -000, -400



**PuraVida®**  
Single lever shower mixer  
concealed  
# 15665, -000, -400



Surface chrome  
(-000)



Surface white/  
chrome (-400)



**PuraVida®**  
Thermostat for 1 function  
Concealed  
# 15775, -000, -400



**PuraVida®**  
Thermostat for 2 functions  
Concealed  
# 15771, -000, -400



**PuraVida®**  
Thermostat  
Concealed  
# 15770, -000, -400  
Highflow Thermostat  
# 15772, -000, -400  
(not shown)



**PuraVida® iControl®**  
Valve for 3 functions  
Concealed  
# 15777, -000, -400



**Trio®/Quattro®**  
Shut-off/diverter valve  
for PuraVida  
# 15937, -000, -400



**Shut-off valve**  
for PuraVida  
# 15978, -000, -400

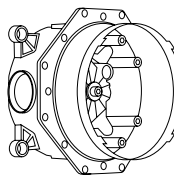

**Basic set for concealed  
thermostats and mixers**  
# 01800180 iBox universal





# PuraVida®

## Showers



**PuraVida® 400**  
Overhead shower (21 l/min)  
# 27437, -000, -400 with shower arm 390 mm  
# 27390, -000, -400 with ceiling connection 100 mm (not shown)



**PuraVida® 150 3jet**  
Hand shower  
# 28557, -000, -400 (16 l/min)  
# 28567, -000, -400 (9 l/min) EcoSmart



**PuraVida® 120 1jet**  
Baton hand shower  
# 28558, -000, -400 (16 l/min)  
# 28568, -000, -400 (9 l/min) EcoSmart



- Ergonomically shaped for the width of shoulders
- Long shower arm for generous freedom of movement
- DualFinish for elegant surfaces



- Innovative design
- 2-shell structure
- Spray modes changed at the push of a button
- Hygienic, internal water guide



**PuraVida® 100**  
Side shower  
# 28430, -000, -400

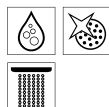

**PuraVida®/Unica® Set**  
# 27853, -000, -400 0.90 m

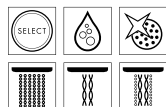

## Accessories



**Porter 'S**  
Shower holder  
# 28331, -000



**PuraVida® Fixfit®**  
DN15 hose connection with ball joint and non-return valve  
# 27414, -000

## Accessories



**PuraVida**  
Liquid soap dispenser  
# 41503, -000



**PuraVida**  
Toothbrush tumbler  
# 41504, -000



**PuraVida**  
Soap dish  
# 41502, -000



**PuraVida**  
Towel hook  
# 41501, -000



**PuraVida**  
Roll holder  
# 41508, -000



**PuraVida**  
Spare roll holder  
# 41518, -000



**PuraVida**  
WC brush with  
ceramic tumbler  
# 41505, -000



**PuraVida**  
Towel holder,  
twin-handle  
# 41512, -000



**PuraVida**  
Grab rail, 300 mm  
# 41513, -000



**PuraVida**  
Bath towel rail, 600 mm  
# 41506, -000

Metris®

# To suit every customer



**Metris® 110**



**User-friendly:** Five basin mixer heights are available offering the right solution for any installation situation.



**Elegant:** Generous handle and spout surfaces lend the bathroom a luxurious ambience.



**Modern:** Metris mixers are designed for discretion, providing space for the personal ComfortZone.



## Advantages and benefits

- Generous surfaces for elegant, quality bathroom design
- The open sweep of the flat handle reflects its ease of use
- Tapered base and precision edges emphasise the character of quality
- Five basin mixer heights for individual free space
- Automatic flow limit to 5 l/min thanks to EcoSmart technology

## Basin/bidet



**Metris® 260**  
Single lever basin mixer  
# 31082, -000 with pop-up waste set  
# 31184, -000 without waste set



**Metris® 230**  
Single lever basin mixer  
with 120° swivel spout  
# 31087, -000 with pop-up waste set  
# 31187, -000 with Push-Open waste  
# 31081, -000 without waste set



**Metris® 200**  
Single lever basin mixer  
# 31183, -000 with pop-up waste set  
# 31185, -000 without waste set



**Metris® 110**  
Single lever basin mixer  
# 31080, -000 with pop-up waste set  
# 31084, -000 without waste set  
# 31203, -000 LowFlow with pop-up waste set  
# 31074, -000 for open water heaters  
# 31204, -000 LowFlow for open water heaters  
# 31121, -000 CoolStart with pop-up waste set  
(not shown)



**Metris® 100**  
Single lever basin mixer  
# 31088, -000 with pop-up waste set  
# 31186, -000 without waste set



**Metris® 100**  
3-hole basin mixer  
# 31083, -000 with fixed spout



**Metris®**  
Single lever basin mixer for wall installation  
# 31086, -000 225 mm  
# 31085, -000 165 mm (not shown)  
Basic set for concealed installation  
# 13622180



**Metris®**  
Pillar tap for small wash basin  
# 31166, -000



**Metris®**  
Single lever bidet mixer  
# 31280, -000 with pop-up waste set



**Metris®**

**Bath**



**Metris®**  
Single lever bath mixer  
exposed  
# 31480, -000



**Metris®**  
Single lever bath mixer  
concealed  
# 31493, -000  
# 31487, -000 with safety combination



**Metris®**  
Single lever bath mixer  
concealed  
# 31454, -000  
# 31451, -000 with safety combination



**Metris®**  
Bath filler  
exposed  
# 31494, -000



**Metris®**  
3-hole rim-mounted mixer  
# 31190, -000  
Basic set for concealed installation  
# 13437180



**Metris®**  
4-hole bath mixer  
for rim-mounted installation  
# 31442, -000  
Basic set for concealed installation  
# 13444180



- No broken tiles thanks to pre-assembled basic set
- Secuflex Box protects the shower hose behind the bath
- Shower hose does not catch when used
- Easy servicing thanks to completely sealed system and easy access from above



**Metris®**  
Single lever bath mixer,  
floor standing, with PuraVida  
120 1jet baton hand shower  
# 31471, -000  
Basic set for concealed  
installation  
# 10452180

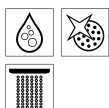

## Shower



**Metris®**  
Single lever shower mixer  
exposed  
# 31680, -000



**Metris®**  
Single lever shower mixer  
concealed  
# 31685, -000



**Metris®**  
Single lever shower mixer  
concealed  
# 31456, -000



**Metris®**  
Thermostat  
concealed  
# 31572, -000 for 1 function (not shown)  
# 31573, -000 for 2 functions



**Metris®**  
Thermostat  
concealed  
# 31570, -000  
Highflow Thermostat  
# 31571, -000 (not shown)



**iControl® S**  
Valve for 3 functions  
concealed  
# 15955, -000

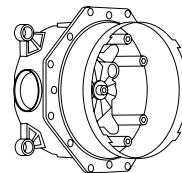

**Basic set for concealed  
thermostats and mixers**  
# 01800180 iBox universal



## Metris® S

### Basin



**Metris® S**  
Single lever basin mixer  
# 31022, -000 with pop-up waste set  
# 31023, -000 without waste set



**Metris® S**  
Single lever basin mixer  
# 31021, -000 with pop-up waste set  
# 31026, -000 without waste set



**Metris® S**  
Single lever basin mixer  
with 120° swivel spout  
# 31159, -000 with pop-up waste set  
# 31161, -000 with Push-Open waste



**Metris® S**  
Single lever basin mixer  
# 31060, -000 with pop-up waste set  
# 31068, -000 without waste set  
# 31063, -000 LowFlow



**Metris® S**  
Single lever basin mixer for wall installation  
# 31162, -000 165 mm (not shown)  
# 31163, -000 225 mm  
Basic set for concealed installation  
# 13622180



**Metris® S**  
Electronic basin mixer with temperature control  
# 31100, -000 Battery operation  
# 31102, -000 Mains connection 230 V  
without temperature control  
# 31101, -000 Battery operation (not shown)  
# 31103, -000 Mains connection 230 V (not shown)



### Bidet



**Metris® S**  
Single lever bidet mixer  
# 31261, -000 with pop-up waste set

## Bath



**Metris® S**  
Single lever bath mixer  
exposed  
# 31460, -000



**Metris® S**  
Single lever bath mixer  
concealed  
# 31465, -000  
# 31466, -000 with safety combination



**Metris® S**  
Bath filler  
exposed  
# 14420, -000



**Metris® S**  
4-hole bath mixer  
for rim-mounted installation  
# 31446, -000 170 mm  
# 31447, -000 220 mm  
# 13444180 Basic set for concealed  
installation

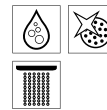

## Shower



**Metris® S**  
Single lever shower mixer  
exposed  
# 31660, -000



**Metris® S**  
Single lever shower mixer  
concealed  
# 31665, -000

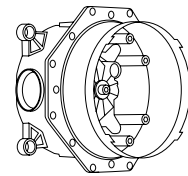

**Basic set for concealed  
thermostats and mixers**  
# 01800180 iBox universal



- Metris S presents a timeless design with a clear, precise flow of lines
- Ergonomic pin handle emphasises the precision of the design languages
- Extensive range for every application
- Also ideal for large scale projects





Talis® Select S/Talis® S

**NEW**

# This is where form and function blend

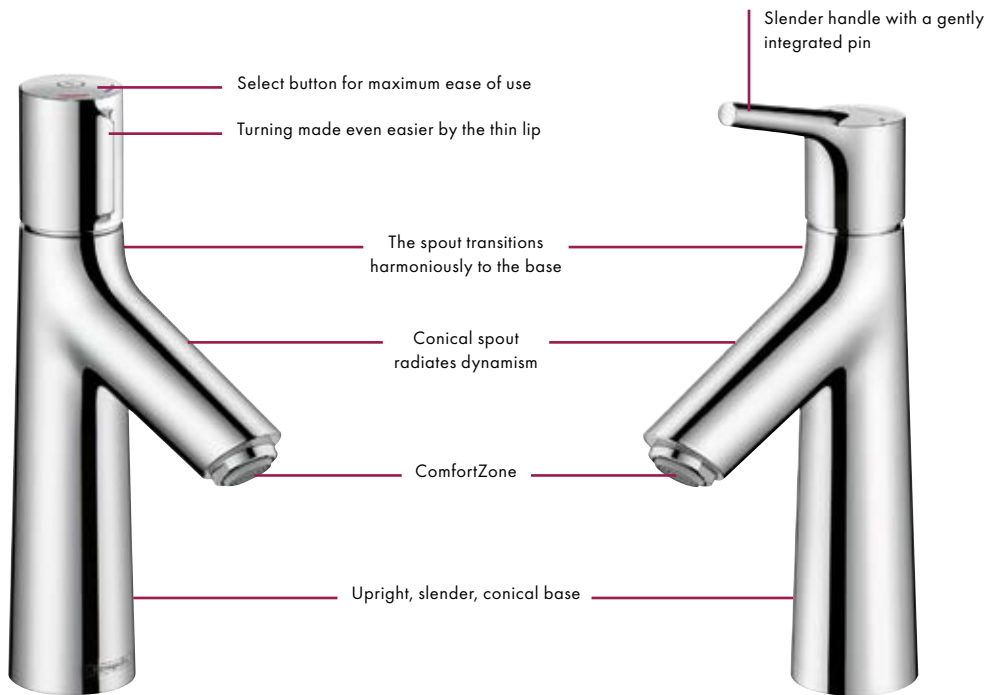

Talis® Select S 100

Talis® S 100



**User-friendly:** Whether with a finger, arm or elbow – the Select button makes operation easier than ever. The temperature can remain pre-set.



**Fine form:** Because the Select button has no lever, the mixer always looks symmetrical. There is no need to turn back the lever, and the water temperature is instantly correct.



**Natural:** Harmonious integration of the mixers in the bathroom thanks to the naturally blending pipe bodies.



## Advantages and benefits

- Select technology makes daily routines easier at the touch of a button
- Helps to save water, since the easy operation encourages the user to keep switching it off
- **Easy to clean:** thanks to the clear conical shapes
- Automatic flow limit to 5 l/min thanks to EcoSmart technology

**NEW**

**Basin**



**Talis® Select S 190**  
Basin mixer  
# 72044, -000 with pop-up waste set  
# 72045, -000 without waste set



**Talis® Select S 100**  
Basin mixer  
# 72042, -000 with pop-up waste set  
# 72043, -000 without waste set



**Talis® Select S 80**  
Basin mixer  
# 72040, -000 with pop-up waste set  
# 72041, -000 without waste set

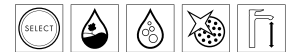

**Talis® S 190**  
Single lever basin mixer  
# 72031, -000 with pop-up waste set  
# 72032, -000 without waste set



**Talis® S 100**  
Single lever basin mixer  
# 72020, -000 with pop-up waste set  
# 72021, -000 without waste set  
# 72022, -000 CoolStart with pop-up waste set (not shown)  
# 72023, -000 CoolStart without waste set (not shown)  
# 72024, -000 LowFlow with pop-up waste set  
# 72025, -000 LowFlow without waste set



**Talis® S 80**  
Single lever basin mixer  
# 72010, -000 with pop-up waste set  
# 72011, -000 with Push-Open waste set  
# 72012, -000 without waste set  
# 72013, -000 CoolStart with pop-up waste set (not shown)  
# 72014, -000 CoolStart without waste set (not shown)  
# 72015, -000 LowFlow with pop-up waste set  
# 72018, -000 LowFlow without waste set  
# 72016, -000 for open water heaters  
# 72017, -000 Pillar tap (not shown)



**Talis® Select S/Talis® S**

**NEW**

**Basin**



**Talis® S 250**  
Single lever basin mixer  
# 72115, -000 with pop-up waste set  
# 72116, -000 without waste set

Available from Q1/2016



**Talis® S 140**  
Single lever basin mixer  
# 72113, -000 with pop-up waste set  
# 72114, -000 without waste set

Available from Q1/2016



**Talis® S 210**  
Single lever basin mixer  
with 120° swivel spout  
# 72105, -000 with pop-up waste set

Available from Q1/2016



- Easy operation thanks to the easy-to-reach pin handle
- **Easy to clean** since the handle on the side means less dirt
- Entirely new design language for additional customer groups
- Suitable for large basins



**Talis® S**  
3-hole basin mixer  
# 72130, -000

Available from Q1/2016



**Talis® S**  
Single lever basin mixer for wall installation  
# 72111, -000 225 mm  
Basic set for concealed installation  
# 13622180



**Talis® S**  
Single lever basin mixer for wall installation  
# 72110, -000 165 mm  
Basic set for concealed installation  
# 13622180



**Bidet**



**Talis® Select S**  
Bidet mixer  
# 72202, -000



**Talis® S**  
Single lever bidet mixer  
# 72200, -000



**NEW**

**Bath**



**Talis® S**  
3-hole rim-mounted mixer  
# 72415, -000  
Basic set for concealed installation  
# 13233180

Available from Q1/2016



**Talis® S**  
3-hole rim-mounted mixer  
# 72416, -000  
Basic set for concealed installation  
# 13437180

Available from Q1/2016



**Talis® S**  
4-hole bath mixer  
for rim-mounted installation  
# 72418, -000  
Basic set for concealed installation  
# 13444180

Available from Q1/2016

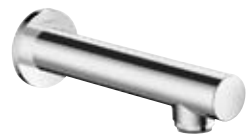

**Talis® S**  
Bath filler  
exposed  
# 72410, -000

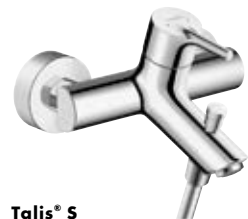

**Talis® S**  
Single lever bath mixer  
exposed  
# 72400, -000



**Talis® S**  
Single lever bath mixer  
concealed  
# 72405, -000  
# 72406, -000 with safety combination



**Talis® S**  
Single lever bath mixer, floor  
standing, with Axor Starck  
baton hand shower  
# 72412, -000  
Basic set for concealed  
installation  
# 10452180

Available from Q1/2016

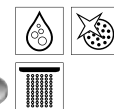

**Shower**



**Talis® S**  
Single lever shower mixer  
exposed  
# 72600, -000



**Talis® S**  
Single lever shower mixer  
concealed  
# 72605, -000  
# 72607, -000 Highflow (not shown)

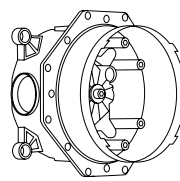

**Basic set for concealed  
thermostats and mixers**  
# 01800180 iBox universal

## Talis®/Talis® S

### Basin



**Talis® 250**  
Single lever basin mixer  
with 60° swivel spout  
# 32055, -000 with Push-  
Open waste



**Talis® 210**  
Single lever basin mixer  
with 120° swivel spout  
# 32082, -000 with Push-  
Open waste  
# 32084, -000 with pop-up  
waste set  
# 32080, -000 with fixed  
spout



**Talis® S**  
Single lever basin mixer  
# 32070, -000 with 360°  
swivel spout and  
waste system  
# 32073, -000 120° swivel  
spout and waste system



**Talis® 150**  
Single lever basin mixer  
with swivel spout  
# 32052, -000 with pop-up  
waste set



**Talis® 80**  
Single lever basin mixer  
with swivel spout  
# 32053, -000 with pop-up waste set



**Talis® 80**  
Single lever basin mixer  
# 32040, -000 with pop-up waste set  
# 32041, -000 without waste set  
# 32046, -000 LowFlow with pop-up  
waste set  
# 32146, -000 LowFlow without waste  
set  
# 32042, -000 for open water heaters  
# 32057, -000 CoolStart with pop-up  
waste set (not shown)



**Talis® 80**  
Pillar tap for small wash basin  
# 32130, -000  
# 13132, -000 (not shown)



**Talis® S**  
Single lever basin mixer  
# 32020, -000 with pop-up waste set  
# 32031, -000 without waste set  
# 32032, -000 with pop-up outflow  
fitting, for open water heaters

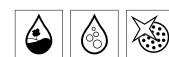

**Talis® 200**  
2-handle basin mixer  
with 120° swivel spout  
# 32030, -000



**Talis® 230**  
3-hole basin mixer  
# 32310, -000



**Talis®**  
Single lever basin mixer  
for wall installation  
# 31618, -000 165 mm  
# 31620, -000 165 mm LowFlow  
# 31611, -000 225 mm (not shown)  
# 13622180 Basic set for concealed  
installation



## Bidet



**Talis®**  
Single lever bidet mixer  
# 32240, -000



**Talis® S**  
Single lever bidet mixer  
# 32220, -000



## Bath



**Talis®**  
Single lever bath mixer  
exposed  
# 32440, -000



**Talis® S**  
Single lever bath mixer  
exposed  
# 32420, -000



**Talis®**  
Single lever bath mixer  
concealed  
# 32475, -000  
# 32477, -000 with safety combination



**Talis®**  
Bath filler  
exposed  
# 13414, -000



## Shower



**Talis®**  
Single lever shower mixer  
exposed  
# 32640, -000



**Talis® S**  
Single lever shower mixer  
exposed  
# 32620, -000



**Talis®**  
Single lever shower mixer  
concealed  
# 32675, -000

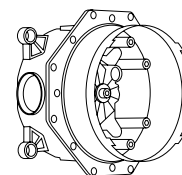

**Basic set for concealed  
thermostats and mixers**  
# 01800180 iBox universal



- Talis and Talis S mixers offer exclusive bathroom designs with functional clarity
- Slender and unadorned design
- Characteristic pin handle for ease of use
- Talis with the swivel spout provides an arc shaped water jet for larger ComfortZones



**Escutcheon diameter** Talis and Talis S: 150 mm. **Matching valves** can be found on page 110.

Talis® Select E/Talis® E

**NEW**

# Comfort in its most natural form

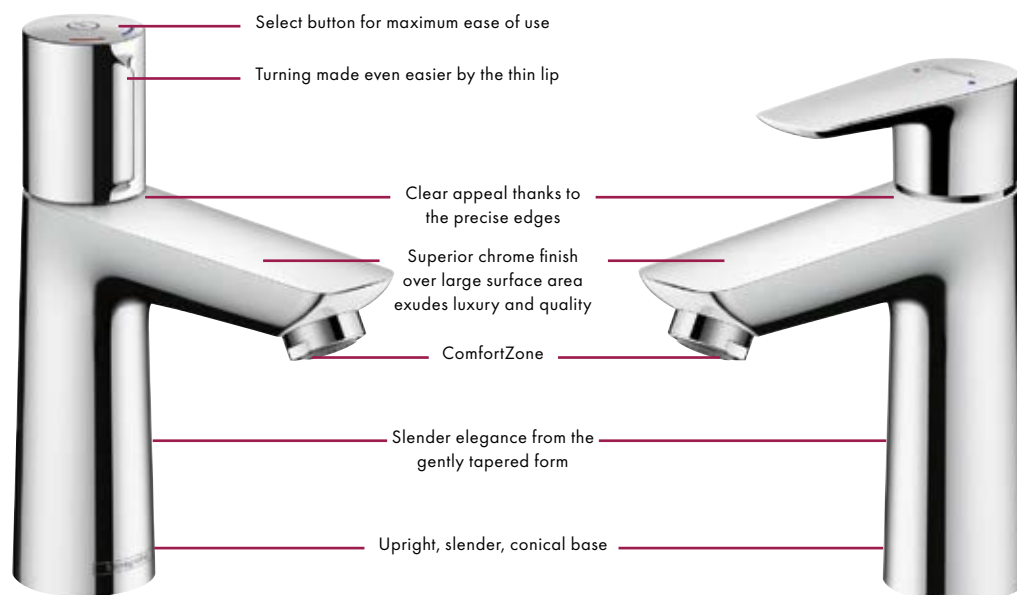

**Talis® Select E 110**

**Talis® E 110**

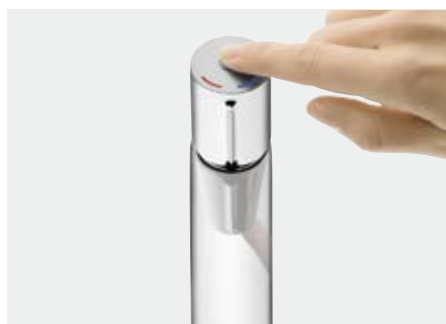

**User-friendly:** Whether with a finger, arm or elbow - the Select button makes operation easier than ever.



**Fine form:** Because the Select button has no lever, the mixer always looks symmetrical. There is no need to turn back the lever, and the water temperature is instantly correct.



**Elegant:** With their precise edges, the mixers contribute to the overall look of harmony in the modern bathroom.



## Advantages and benefits

- Select technology makes daily routines easier at the touch of a button
- **Easy to clean:** thanks to the generous areas
- Helps to save water, since the easy operation encourages the user to keep switching it off
- Automatic flow limit to 5 l/min thanks to EcoSmart technology

**NEW**

**Basin**



**Talis® Select E 240**  
Basin mixer  
# 71752, -000 with pop-up waste set  
# 71753, -000 without waste set

Available from Q1/2016



**Talis® Select E 110**  
Basin mixer  
# 71750, -000 with pop-up waste set  
# 71751, -000 without waste set

Available from Q1/2016



**Talis® E 240**  
Single lever basin mixer  
# 71716, -000 with pop-up waste set  
# 71717, -000 without waste set



**Talis® E 110**  
Single lever basin mixer  
# 71710, -000 with pop-up waste set  
# 71711, -000 with Push-Open waste  
# 71712, -000 without waste set  
# 71713, -000 CoolStart with pop-up waste set (not shown)  
# 71714, -000 CoolStart without waste set (not shown)  
# 71715, -000 LowFlow with pop-up waste set  
# 71709, -000 LowFlow without waste set



**Talis® E 80**  
Single lever basin mixer  
# 71700, -000 with pop-up waste set  
# 71701, -000 with Push-Open waste  
# 71702, -000 without waste set  
# 71703, -000 CoolStart with pop-up waste set (not shown)  
# 71704, -000 CoolStart without waste set (not shown)  
# 71705, -000 LowFlow with pop-up waste set  
# 71708, -000 LowFlow without waste set  
# 71707, -000 for open water heaters  
# 71706, -000 Pillar tap (not shown)





# Talis® E

**NEW**

## Basin



**Talis® E 150**  
Single lever basin mixer  
# 71754, -000 with pop-up waste set  
# 71755, -000 without waste set

Available from Q1/2016



**Talis® E**  
3-hole basin mixer  
# 71733, -000

Available from Q1/2016



**Talis® E**  
Single lever basin mixer for wall installation  
# 71732, -000 165 mm  
# 71734, -000 225 mm (not shown)



- Easy operation thanks to the easy-to-reach pin handle
- **Easy to clean** since the handle on the side means less dirt
- Entirely new design language for additional customer groups
- Suitable for large basins

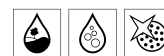

## Bidet



**Talis® E**  
Single lever bidet mixer  
# 71720, -000 with pop-up waste set  
# 71721, -000 with Push-Open waste



**NEW**

**Bath**



**Talis® E**  
3-hole rim-mounted mixer  
# 71747, -000  
Basic set for concealed installation  
# 13233180

Available from Q1/2016



**Talis® E**  
3-hole rim-mounted mixer  
# 71730, -000  
Basic set for concealed installation  
# 13437180

Available from Q1/2016



**Talis® E**  
4-hole bath mixer  
for rim-mounted installation  
# 71748, -000  
Basic set for concealed installation  
# 13444180

Available from Q1/2016



**Talis® E**  
Single lever bath mixer  
exposed  
# 71740, -000



**Talis® E**  
Single lever bath mixer  
concealed  
# 71745, -000  
# 71474, -000 with safety combination



**Talis® E**  
Bath filler  
exposed  
# 71410, -000



**Shower**



**Talis® E**  
Single lever shower mixer  
exposed  
# 71760, -000



**Talis® E**  
Single lever shower mixer  
concealed  
# 71765, -000

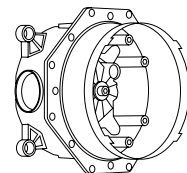

**Basic set for concealed thermostats and mixers**  
# 01800180 iBox universal

Focus®

# With top quality, comfort and great value



Focus® 100



**User-friendly:** Gentle, caressing roundness and the ergonomic handle invite you to try out the ease of use.



**Living:** The cylindrical, contemporary body of Focus mixers brings elegance and value to the bathroom.



## Advantages and benefits

- Design complete in itself and expressed in a clear, generous language
- Ergonomic handle for ease of use
- Dynamic silhouette and gentle round shapes emphasise the quality
- Excellent value with a high level of comfort
- Automatic flow limit to 5 l/min thanks to EcoSmart technology

## Basin/bidet



**Focus® 240**  
Single lever basin mixer  
with 120° swivel spout  
# 31609, -000 with pop-up  
waste set  
# 31519, -000 without waste  
set



**Focus® 190**  
Single lever basin mixer  
# 31608, -000 with pop-up  
waste set  
# 31518, -000 without waste  
set



**Focus® 100**  
Single lever basin mixer  
# 31607, -000 with pop-up  
waste set  
# 31517, -000 without waste set  
# 31603, -000 LowFlow with  
pop-up waste set  
# 31513, -000 LowFlow without  
waste set  
# 31621, -000 CoolStart with  
pop-up waste set (not shown)



**Focus® 70**  
Single lever basin mixer  
# 31730, -000 with pop-up waste  
set  
# 31733, -000 without waste set  
# 31951, -000 LowFlow with  
pop-up waste set  
# 31952, -000 LowFlow without  
waste set  
# 31132, -000 for open water  
heaters  
# 31604, -000 with Push-Open  
waste  
# 31130, -000 Pillar tap  
(not shown)  
# 31539, -000 CoolStart with  
pop-up waste set (not shown)



**Focus®**  
Single lever basin mixer for wall  
installation  
# 31923, -000



**Focus®**  
Electronic basin mixer with  
temperature control  
# 31171, -000 Battery  
operation  
# 31173, -000 Mains  
connection 230 V



**Focus®**  
Electronic basin mixer without  
temperature control  
# 31172, -000 Battery  
operation  
# 31174, -000 Mains  
connection 230 V



**Focus®**  
Single lever bidet mixer  
# 31920, -000 with pop-up  
waste set  
# 31922, -000 with Push-Open  
waste



## Bath



**Focus®**  
Single lever bath mixer  
exposed  
# 31940, -000



**Focus®**  
Single lever bath mixer  
concealed\*  
# 31945, -000  
# 31946, -000 with safety  
combination



**Focus®**  
Bath filler  
exposed  
# 13414, -000



## Shower



**Focus®**  
Single lever shower mixer  
exposed  
# 31960, -000



**Focus®**  
Single lever shower mixer  
concealed\*  
# 31965, -000

**i** **Kitchen mixers** in the Focus line can be found on pages 194 onwards.  
**Escutcheon diameter** Focus: 150 mm. \***Basic set for concealed mixers** # 01800180 iBox universal.  
**Focus Care** products for persons of restricted mobility can be found on pages 174 onwards.

Logis®

**NEW**

# Harmonious design with precision feeling



**Logis® 100**



**Pleasing:** The precise shoulder lines and rounded edges delight both the eye and the hand.



**Flexible:** The extensive range has the best and most irresistible solution for any installation situation.



**Homely:** Thanks to the gentle silhouettes, the Logis mixers create a harmonious atmosphere.



## Advantages and benefits

- Clear, generous surfaces for easy operation and cleaning
- The rounded shapes of the handle and base make them the perfectly matching complements to the soft edges of the basin
- High-value, quiet ceramic cartridge – perfect for apartment blocks, hotels and offices
- High value in the lower price category
- Extensive range with various basin mixer heights
- Automatic flow limit to 5 l/min thanks to EcoSmart technology

**NEW**

**Basin/bidet**



**Logis® 210**  
 Single lever basin mixer  
 with 120° swivel spout  
 # 71130, -000 with pop-up waste set  
 # 71131, -000 without waste set



**Logis® 190**  
 Single lever basin mixer  
 # 71090, -000 with pop-up waste set  
 # 71091, -000 without waste set



**Logis® 100**  
 Single lever basin mixer  
 # 71100, -000 with pop-up waste set  
 # 71107, -000 with Push-Open waste set  
 # 71102, -000 CoolStart with pop-up waste set (not shown)  
 # 71103, -000 CoolStart without waste set (not shown)  
 # 71101, -000 without waste set



**Logis® 70**  
 Single lever basin mixer  
 # 71070, -000 with pop-up waste set  
 # 71077, -000 with Push-Open waste set  
 # 71072, -000 CoolStart with pop-up waste set (not shown)  
 # 71073, -000 CoolStart without waste set (not shown)  
 # 71071, -000 without waste set  
 # 71074, -000 for open water heaters  
 # 71078, -000 with pop-up waste set



**Logis®**  
 Single lever basin mixer  
 for wall installation  
 # 71220, -000 195 mm  
 # 13622180 Basic set for  
 concealed installation



**Logis®**  
 Single lever basin mixer for wall installation  
 Exposed  
 # 71225, -000



**Logis®**

**NEW**

**Basin**



**Logis®**  
3-hole basin mixer  
# 71133, -000 with pop-up waste set



**Logis®**  
2-handle basin mixer  
# 71222, -000 with pop-up waste set  
# 71221, -000 without waste set



**Logis® 70**  
Pillar tap  
# 71120, -000 Cold water  
# 71121, -000 Warm water (not shown)



**Bidet**



**Logis® 70**  
Single lever bidet mixer  
# 71204, -000



**Logis® 100**  
Single lever bidet mixer  
# 71200, -000



**NEW**

**Bath**



**Logis**  
Single lever bath mixer  
exposed  
# 71400, -000



**Logis**  
2-handle bath mixer exposed installation  
# 71243, -000



**Logis**  
Single lever bath mixer  
concealed  
# 71405, -000  
# 71407, -000 with safety combination



**Logis**  
Bath filler  
exposed  
# 71410, -000



**Logis**  
3-hole rim-mounted mixer  
# 71310, -000  
Basic set for concealed installation  
# 13437180



**Shower**



**Logis**  
Single lever shower mixer  
exposed  
# 71600, -000



**Logis**  
2-handle shower mixer exposed installation  
# 71263, -000



**Logis**  
Single lever shower mixer  
concealed  
# 71605, -000  
# 71607, -000 Highflow (not shown)



**Logis**  
Shut-off valve  
# 71970, -000

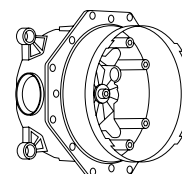

**Basic set for concealed  
thermostats and mixers**  
# 01800180 iBox universal

Bath mixers – Logis



Metris® Classic

# Modern classic with elegant design



Metris® Classic 100



**Elegant:** The brilliant and smooth surface of the mixers presents highlights of luxury in every bathroom.



**Classical:** The elegant design with discreetly shaped handle and spout emanate high quality and pleasure.



## Advantages and benefits

- Balanced, minimal design with unpretentious classical elegance
- Automatic flow limit to 5 l/min thanks to EcoSmart technology
- Very slender and easy to operate thanks to the M1 cartridge
- Connected via temperature-resistant, taste- and odour-neutral PEX hoses
- **Easy to clean:** thanks to the exclusive, long-lasting chrome surface
- With scald protection for added safety

## Basin/bidet



**Metris® Classic 250**  
Single lever basin mixer  
# 31078, -000 with pop-up  
waste set



**Metris® Classic 100**  
Single lever basin mixer  
# 31075, -000 with pop-up  
waste set  
# 31077, -000 without waste  
set



**Metris® Classic**  
Single lever basin mixer for  
wall installation  
# 31003, -000 225 mm  
Basic set for concealed  
installation  
# 13622180



**Metris® Classic 100**  
3-hole basin mixer  
# 31073, -000 with pop-up  
waste set



**Metris® Classic**  
Single lever bidet mixer  
# 31275, -000 with pop-up  
waste set



## Bath



**Metris® Classic**  
Single lever bath mixer  
exposed  
# 31478, -000



**Metris® Classic**  
Single lever bath mixer  
concealed  
# 31485, -000



**Metris® Classic**  
Bath filler  
exposed  
# 13413, -000



## Shower



**Metris® Classic**  
Single lever shower mixer  
exposed  
# 31672, -000



**Metris® Classic**  
Single lever shower mixer  
concealed  
# 31676, -000



**Fixfit® Classic**  
DN15 hose connection with  
non-return valve  
# 16884, -000

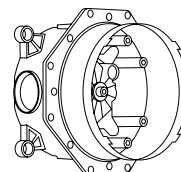

**Basic set for concealed  
thermostats and mixers**  
# 01800180 iBox universal

Talis® Classic

# The harmony of classic elegance



Talis® Classic 80



**Natural:** The mixers in the Talis Classic line combine original charm and pioneering water saving technology.



**Supreme:** Geometrical transitions, refined sweeps and discreet lines introduce a calm, yet exciting style to the bathroom.



## Advantages and benefits

- Cylindrical basic form and tall geometry emanate elegance
- Very slender and easy to operate thanks to the M1 cartridge
- Pin handle for ease of use
- Automatic flow limit to 5 l/min thanks to EcoSmart technology
- Connected via temperature-resistant, taste- and odour-neutral PEX hoses
- With scald protection for added safety

## Basin/bidet



**Talis® Classic 230**  
Single lever basin mixer  
# 14116, -000 with pop-up  
waste set



**Talis® Classic 80**  
Single lever basin mixer  
# 14111, -000 with pop-up  
waste set  
# 14118, -000 without waste  
set



**Talis® Classic Natural 90**  
Single lever basin mixer  
# 14127, -000 with pop-up  
waste set



**Talis® Classic**  
Single lever bidet mixer  
# 14120, -000 with pop-up  
waste set



## Bath



**Talis® Classic**  
Single lever bath mixer  
exposed  
# 14140, -000



**Talis® Classic**  
Single lever bath mixer  
concealed  
# 14145, -000

## Shower



**Talis® Classic**  
Single lever shower mixer  
exposed  
# 14161, -000



**Talis® Classic**  
Single lever shower mixer  
concealed  
# 14165, -000

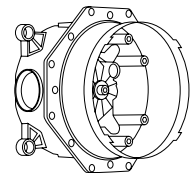

**Basic set for concealed  
thermostats and mixers**  
# 01800180 iBox universal



Logis® Classic

**NEW**

# The perfect blend of elegance and functionality

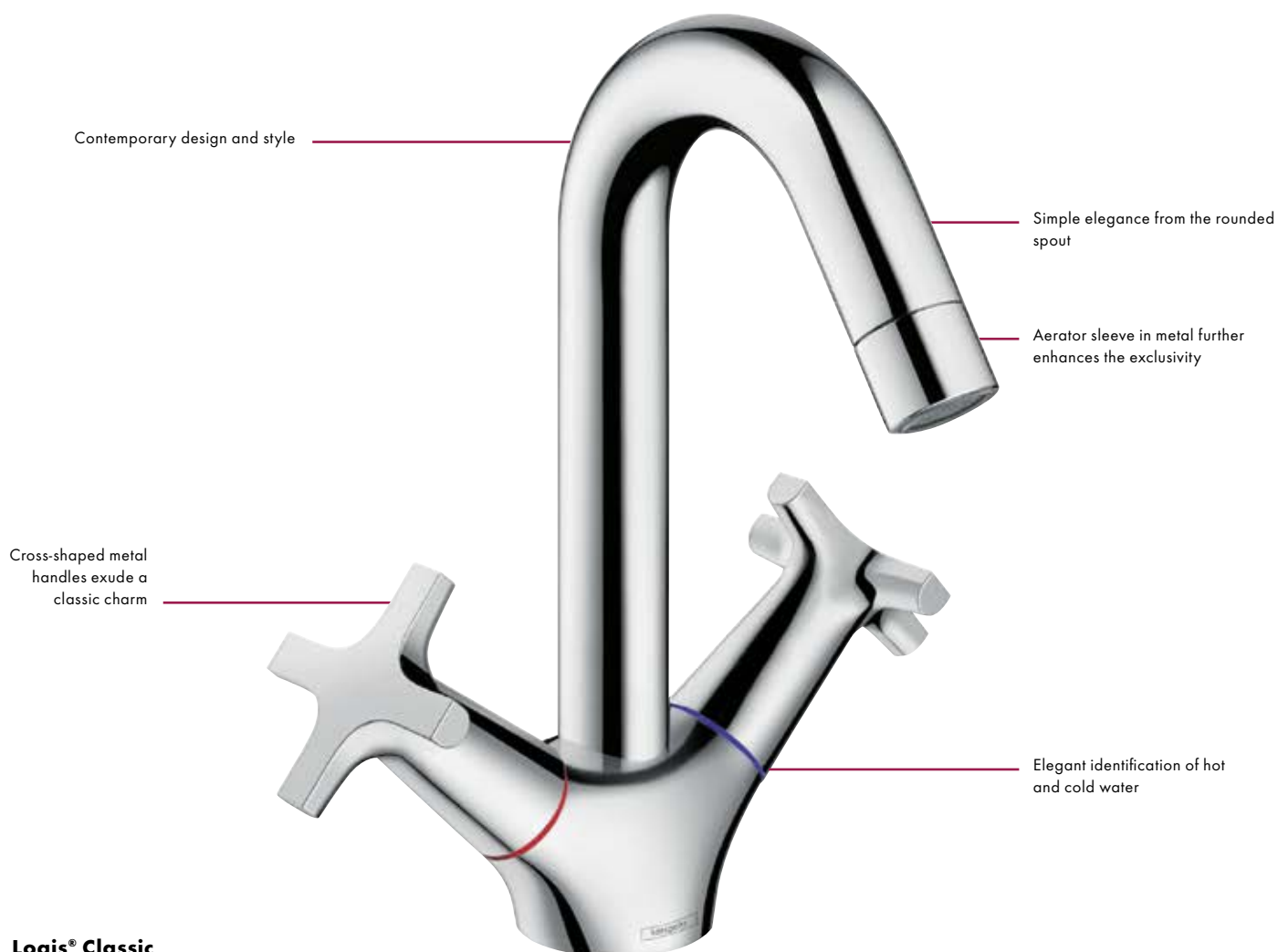

**Logis® Classic**



## Advantages and benefits

- Elegant design with classic elements
- Basic shape adapted to the basin for harmonious integration
- **Easy to clean:** thanks to the clear cylindrical shapes
- Swivel range limited for easier handling
- Long-lasting ceramic valves in the entire range
- Automatic flow limit to 5 l/min thanks to EcoSmart technology
- Also available as low-pressure versions
- Hansgrohe quality at entry-level prices

**NEW**

**Basin**



**Logis® Classic**  
2-handle basin mixer  
# 71270, -000 with pop-up waste set  
# 71272, -000 with Push-Open waste



**Logis® Classic**  
3-hole basin mixer  
# 71323, -000 with pop-up waste set



**Logis® Classic**  
Pillar tap  
# 71135, -000 Cold water  
# 71136, -000 Warm water (not shown)



**Bath**



**Logis® Classic**  
2-handle bath mixer exposed installation  
# 71240, -000



**Shower**



**Logis® Classic**  
2-handle shower mixer exposed installation  
# 71260, -000



**Logis® Classic**  
Shut-off valve  
# 71976, -000

Care mixers

# More comfort and safety with Hansgrohe Care

Longer handles, intuitive use, constant temperatures, large lettering: The mixers in the Talis Care and Focus Care lines and the Ecostat Comfort Care thermostats provide that extra safety, comfort and ease of use in the bathroom.

The resulting ease in handling water offers particular benefits to families with small children. These perfected solutions are ideal wherever people are in need of assistance owing to their age or illness or wherever

special hygiene conditions apply: i. e. at retirement homes, hospitals, health resorts, or hospices. But also where greater ease of use and safety are required, for instance in nursery schools, or hotels.



## Focus® Care

Single lever basin mixer

## Ecostat® Comfort Care

Shower thermostat



### Advantages and benefits

- Extra long, flat control lever: ergonomically formed for the whole hand or arm
- Comfortable use under a light touch
- Robust brass body and metal handle for a particularly long lifetime
- Temperature preset, e. g. for people who have lost their feeling for hot and cold

## Talis® Care

### Basin



**Talis® Care 80**  
Single lever basin mixer  
# 32035, -000



**Talis® Care**  
Single lever basin mixer  
exposed  
# 32037, -000

### Bath



**Ecostat® Comfort Care**  
Bath thermostat  
exposed  
# 13115, -000

### Shower



**Talis® Care**  
Single lever shower mixer  
exposed  
# 32641, -000



**Ecostat® Comfort Care**  
Shower thermostat  
exposed  
# 13117, -000



## Focus® Care

### Basin



**Focus® Care 100**  
Single lever basin mixer  
# 31911, -000 with pop-up  
waste set  
# 31915, -000 without waste  
set  
# 31917, -000 CoolStart  
without waste set (not shown)



**Focus® Care 70**  
Single lever basin mixer  
# 31910, -000 with pop-up  
waste set  
# 31914, -000 without waste  
set



**Focus® Care**  
Single lever basin mixer  
exposed  
# 31913, -000

### Shower



**Focus® Care**  
Single lever shower mixer  
exposed  
# 31916, -000



- User optimised lever length 121 mm
- Strong metal body and handle
- Laminar spray



**Under-basin thermostat**  
exposed  
# 15346, -000



**Quick coupling**  
# 28346, -000



- Easy to connect to existing valves, e.g. under the basin
- Provides a constant temperature and consistent flow even with fluctuating cold water pressure
- Safety e.g. in nursery schools, hospitals or hotels
- Safe for thermal disinfection

- For quick, easy emptying of hoses



Electronic basin mixer

# Sensors for greater hygiene and water savings

Here, water flows only when it is actually needed: Contactless mixers with infrared proximity electronics are especially useful in public facilities for saving water – and

hence for cutting the costs of consumption and energy. In addition, the contactless technology eliminates the risk of contamination associated with heavily used mixers in public and

corporate washrooms. Above all on the care and health sectors, hygiene experts recommend sensor controlled water sources.



**Focus®**  
Electronic basin mixer



## Advantages and benefits

- Water savings thanks to automatic stop
- Available for battery and mains connection
- Contactless, so particularly hygienic
- Ideal for public and business sectors
- WELL certified

## Electronic basin mixer

### PuraVida®



#### PuraVida®

Electronic basin mixer with temperature control  
 # 15170, -000, -400 Battery operation  
 # 15172, -000, -400 Mains connection 230 V



### Metris® S



#### Metris® S

Electronic basin mixer with temperature control  
 # 31100, -000 Battery operation  
 # 31102, -000 Mains connection 230 V



#### Metris® S

Electronic basin mixer without temperature control  
 # 31101, -000 Battery operation  
 # 31103, -000 Mains connection 230 V



### Focus®



#### Focus®

Electronic basin mixer with temperature control  
 # 31171, -000 Battery operation  
 # 31173, -000 Mains connection 230 V



#### Focus®

Electronic basin mixer without temperature control  
 # 31172, -000 Battery operation  
 # 31174, -000 Mains connection 230 V



# Accessories

## Logis®



**Liquid soap dispenser**  
Glass  
# 40514, -000



**Toothbrush tumbler**  
Glass  
# 40518, -000



**Soap dish**  
Glass  
# 40515, -000



**Towel hook**  
# 40511, -000



**Roll holder**  
# 40523, -000



**Roll holder**  
without cover  
# 40526, -000



**Spare roll holder**  
# 40517, -000



**Toilet brush tumbler**  
Glass  
# 40522, -000

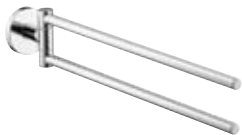

**Towel holder**  
twin-handle  
# 40512, -000



**Grab rail**  
300 mm  
# 40513, -000



**Bath towel rail**  
600 mm  
# 40516, -000

## Logis® Classic



**Liquid soap dispenser**  
Ceramics  
# 41614, -000



**Toothbrush tumbler**  
Ceramics  
# 41618, -000



**Soap dish**  
Ceramics  
# 41615, -000



**Towel hook**  
# 41611, -000



**Roll holder**  
# 41623, -000



**Roll holder**  
without cover  
# 41626, -000



**Spare roll holder**  
# 41617, -000



**Toilet brush tumbler**  
Ceramics  
# 41632, -000

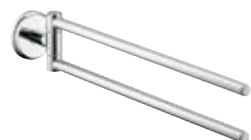

**Towel holder**  
twin-handle  
# 41612, -000



**Grab rail**  
300 mm  
# 41613, -000



**Bath towel rail**  
600 mm  
# 41616, -000

Hansgrohe waste systems

# Discreet design, perfect function

Cleanliness is indispensable for well being in the bathroom. For this reason, Hansgrohe has developed a large number of innovative waste systems. The used water can

then drain off quickly and easily. Flexible models like Exafill, Flexaplust, Raindrain and Flowstar are easy to install and in addition are perfectly easy to use. Overflow control and

other intelligent functions maintain comfort on a high level for a very long time.



**Push-Open:** The Push-Open waste is opened and closed at the tap of a finger and water can collect and drain off very easily.



**Flowstar®:** The Flowstar waste system also presents a visually clean solution under the wash basin.



**Exafill® S bath:** The integrated fine flood spray fills the bath easily and free of splashes, so a separate bath filler is not needed. Exafill S is everything in one: bath filler, outflow and overflow. Better still: The installation is pleasantly uncomplicated - and with QuickClean technology cleaning the filler nozzles is just as easy.



**Flexaplus® S bath:** Never again a bath that has run too full. The outflow and overflow mixer regulates excess bath water through the overflow control element. In addition, the water level in the bath can be raised by up to 25 mm - for even more bath fun.



**Raindrain® 90 XXL shower:** Ideal for large showers with high flow rates like Raindance Rainfall or Raindance Rainmaker. Provides for a fast and uncomplicated outflow in all shower trays. The perfect shower outflow with a max capacity of 51 l/min and easy installation.



## Advantages and benefits

- Water can drain off quickly and easily
- Easy to install and use
- Reliable even for large showers with high flow rates
- Overflow control and other intelligent functions

## Siphons



**Flowstar® designer siphon**

# 52100, -000  
 Set: 1 Flowstar,  
 2 angle valve bolts  
 (without angle valve)  
 # 52110, -000 (not shown)  
 Set: 1 Flowstar,  
 2 angle valve bolts  
 (incl. angle valve)  
 # 52120, -000 (not shown)



**Flowstar® S designer siphon**

# 52105, -000



**Angle valve E**

# 13902, -000



**Angle valve S**

# 13901, -000



**Free-flow waste**

Push-Open  
 # 50100, -000



**Free-flow waste**

Push-Open  
 # 50105, -000



**Free-flow waste**

with closed cover plate  
 # 50001, -000, -800



**Waste set**

with tilting lever  
 # 94139, -000

## Waste systems for showers



**Raindrain® 90 XXL**  
 Complete set 51 l/min  
 # 60067, -000



- Flow performance max 51 l/min
- Easy installation



**Staro® '90**  
 Complete set 29 l/min  
 # 60056, -000



**Staro® '90**  
 Basic set 29 l/min  
 # 60054180



**Staro® '90**  
 Finish set  
 # 60055, -000



**Staro® '52**  
 Complete set 33 l/min  
 # 60060, -000



**Starolift® '52**  
 Basic set 33 l/min  
 # 60052180



**Starolift® '52**  
 Finish set  
 # 60053, -000

## Waste systems for bath tubs



**Flexaplusth**  
# 58143, -000  
Waste and overflow complete set with flexible hose for standard tubs



**Flexaplusth S**  
# 58150, -000  
Waste and overflow complete set with flexible hose for standard tubs



**Flexaplusth**  
# 58140180  
Waste and overflow basic set with flexible hose for standard tubs



**Flexaplusth**  
# 58141180  
Waste and overflow basic set with flexible hose for special tubs



- Spring loaded plug protects against injury
- Self cleaning screw siphon

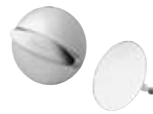

**Flexaplusth**  
# 58185, -000 Finish set



**Flexaplusth S**  
# 58186, -000 Finish set



**Exafillth**  
# 58123, -000  
Bath filler with waste and overflow complete set for standard tubs



**Exafillth**  
# 58125180  
Bath filler with waste and overflow basic set for standard tubs



**Exafillth**  
# 58126180  
Bath filler with waste and overflow basic set for special tubs



**Exafillth**  
# 58127, -000 Finish set



**Exafillth S**  
# 58113, -000  
Bath filler with waste and overflow complete set for standard tubs



**Exafillth S**  
# 58115180  
Bath filler with waste and overflow basic set for standard tubs



**Exafillth S**  
# 58116180  
Bath filler with waste and overflow basic set for special tubs



**Exafillth S**  
# 58117, -000  
Finish set



- Flexibly adaptable to bath forms



# KITCHEN MIXERS

---

**Mixer diversity where know-how quality, functionality and design come together:**

PuraVida® | Metris® Select | Metris® | Talis® Select S | Talis® S | Focus® | Logis® | Logis® Classic



Select technology

# Comfort at the touch of a button – to suit your customers' taste

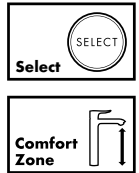

The innovative Select technology provides extremely comfortable operation at the touch of a button – including in the kitchen of course. Many people find cooking helps them to relax and switch off. And switching off is the key. With the Select button, it happens

literally at the touch of a hand – or elbow. This keeps the mixer clean even if the user has dirty hands. It's easier to turn the water off between various tasks, which means it's also easier to avoid wasting water. So cooking remains relaxing thanks to the modern yet practical





design of Hansgrohe's kitchen mixers – even the pull-out spray is available with Select technology. Intelligent handling then turns cooking into a real pleasure.









**More freedom of movement:** The Select button is operated almost in passing, bringing added comfort and more flexibility into daily activities.

Hansgrohe kitchen mixers

# The kitchen mixer lines at a glance

	<b>PuraVida®</b>	<b>Metris® Select/Metris®</b>		<b>Talis® Select S/Talis® S</b>	
					
<b>Product name</b>	<b>PuraVida® 280</b>	<b>Metris® Select 320</b>	<b>Metris® 320</b>	<b>Talis® Select S 300</b>	<b>Talis® S 200</b>
With Select technology	-	Yes	-	Yes	-
With pull-out spray	-	-	# 14820, -000, -800	-	# 72813, -000, -800
With pull-out spout	-	# 14884, -000, -800	# 14821, -000, -800	# 72821, -000, -800	-
With swivel spout	# 15805, -000, -800 # 15812, -000, -800	# 14883, -000, -800	# 14822, -000, -800	# 72820, -000, -800	# 72810, -000, -800
For window installation	-	-	# 14823, -000	-	-
For open water heaters	-	-	-	-	# 72812, -000
With shut-off valve	-	-	# 14888, -000	-	-

Versions

Talis® S <sup>2</sup> Variarc	Talis® S	Focus®		Logis®		
						
<b>Talis® S<sup>2</sup> Variarc</b>	<b>Talis® S</b>	<b>Focus® 240</b>	<b>Focus® 160</b>	<b>Logis® 260</b>	<b>Logis® 200</b>	<b>Logis® 160</b>
-	-	-	-	-	-	-
# 14877, -000, -800	# 32841, -000, -800	# 31815, -000, -800	-	-	-	-
# 14872, -000, -800	-	-	-	-	-	-
# 14870, -000, -800	# 32851, -000, -800	# 31817, -000, -800	# 31806, -000, -800	# 71835, -000	# 71280, -000	# 71832, -000
# 14877, -000, -800	-	-	-	-	-	# 71830, -000
# 14872, -000, -800	-	-	-	-	-	# 71833, -000
# 14873, -000	# 32842, -000	# 31822, -000	# 31804, -000	-	-	# 71831, -000
# 14875, -000	# 32852, -000	# 31822, -000	# 31804, -000	-	-	# 71831, -000
# 14875, -000	# 32855, -000	# 31823, -000	# 31803, -000	-	-	# 71834, -000

PuraVida® 2-hole single lever kitchen mixer

# Leaves no wish unfulfilled for perfect ergonomics

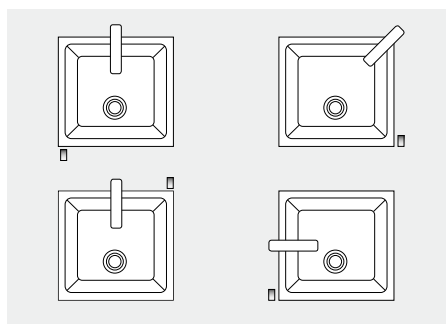

Examples of installation possibilities



**PuraVida®**  
2-hole single lever kitchen mixer with 120° swivel spout (Stainless steel look illustrated)  
# 15812, -000, -800



## Advantages and benefits

- Used separately from the basic set for impressive aesthetics
- Individual positioning of the mixer and handle around the sink for convenience and ergonomics
- High swivel spout for greater freedom of movement between the spout and sink
- DualFinish with smooth transition from the brushed base to the polished spout

Find out more at <http://pro.hansgrohe-int.com/kitchen>

PuraVida® 2-hole electronic kitchen mixer

# Intelligent functionality at the sink



## Quick temperature selection



## Temperature



## Volume



## Cleaning

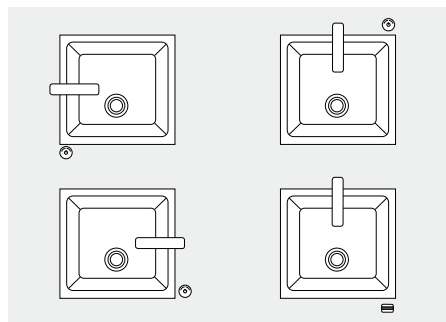
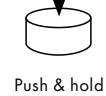

Examples of installation possibilities



**PuraVida®**  
2-hole electronic kitchen mixer  
with 120° swivel spout  
(Stainless steel look illustrated)  
# 15805, -000, -800



## Advantages and benefits

- Used separately from the basic set for impressive aesthetics
- Individual positioning of the mixer and handle around the sink for convenience and ergonomics
- High swivel spout for greater freedom of movement between the spout and sink
- Pressed button and twisting for ease of use
- LED illuminated ring for water temperature
- DualFinish with smooth transition from the brushed base to the polished spout

Find out more at <http://pro.hansgrohe-int.com/kitchen>

Metris® Select

# Easy operation is the best recipe

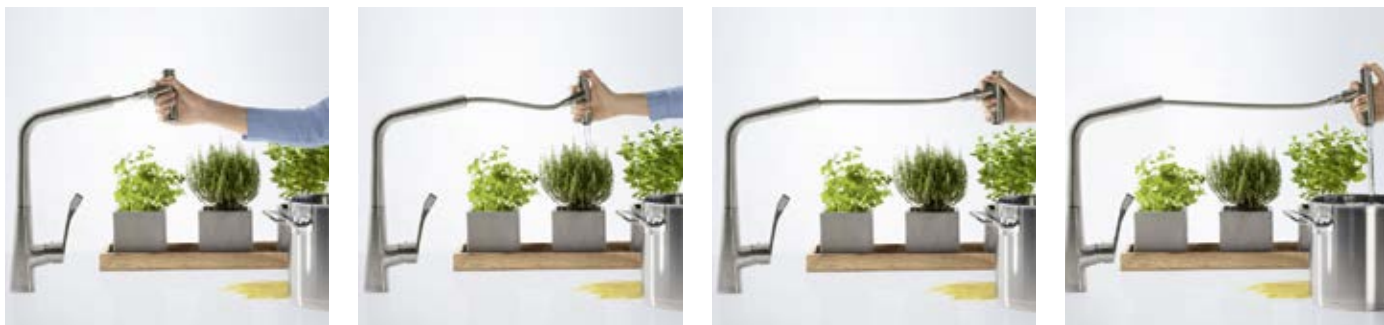
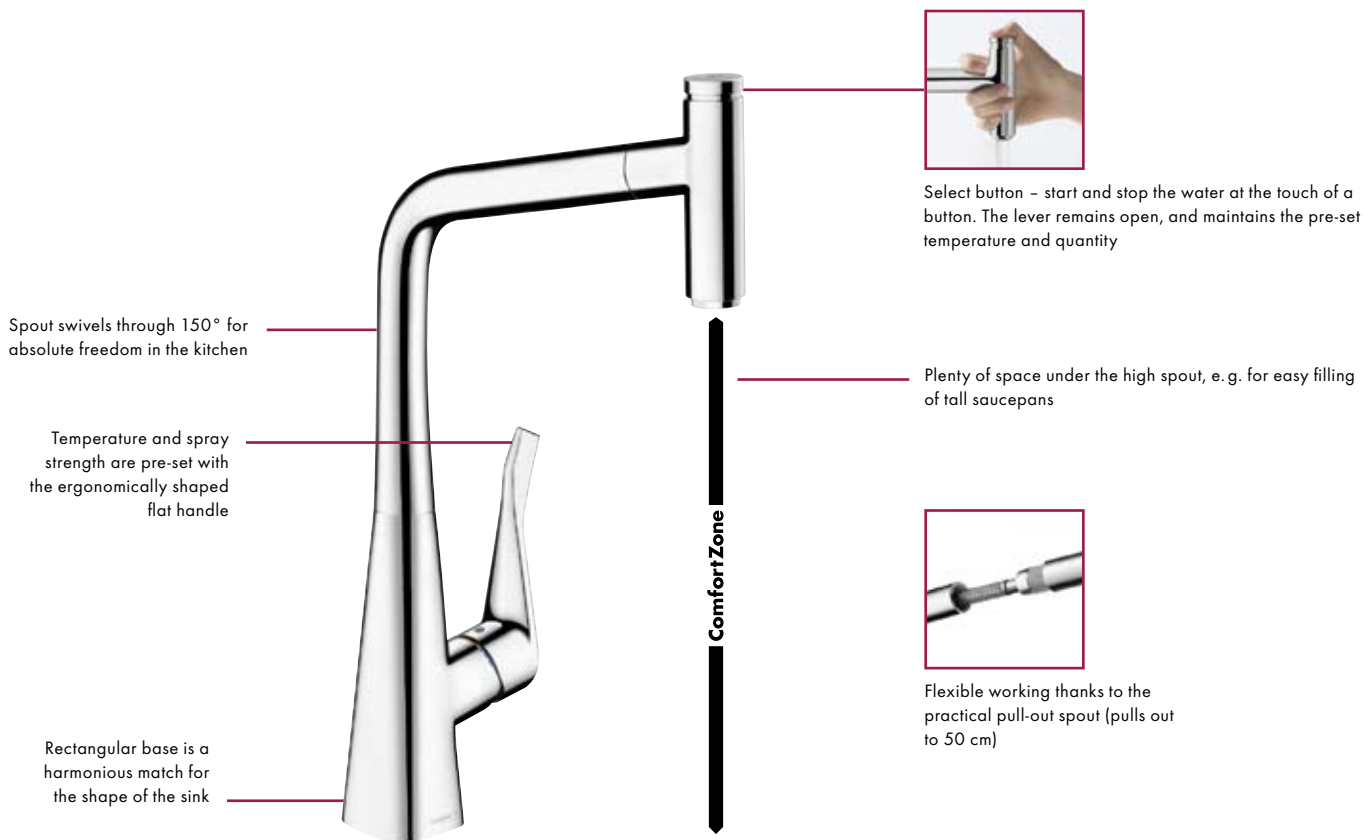

**Flexible:** Tasks blend seamlessly thanks to the combination of intuitive Select button and practical pull-out spout – for more comfort in the kitchen and beyond the sink.



## Advantages and benefits

- Mixer easy to turn on and off at the touch of a button
- Intuitive control concept makes it ideal for all ages
- New spray design for easy handling with no irritating twisting of the wrist
- Ergonomic flat handle design for better adjustment of the water temperature and quantity
- Basic form matches the shape of the sink and integrates harmoniously in the kitchen

## Metris® Select

**NEW**



**Metris® Select 320**  
Single lever kitchen mixer  
with pull-out spout,  
150° swivel spout  
# 14884, -000, -800



**Metris® Select 320**  
Single lever kitchen mixer  
with 110°/150°/360° swivel spout  
# 14883, -000, -800

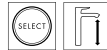

## Metris®



**Metris® 320**  
Single lever kitchen mixer  
with pull-out spray,  
two spray types,  
110°/150° swivel spout  
# 14820, -000, -800

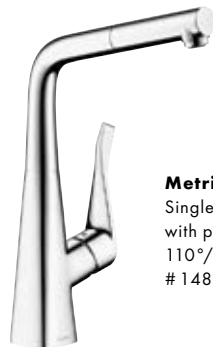

**Metris® 320**  
Single lever kitchen mixer  
with pull-out spout,  
110°/150° swivel spout  
# 14821, -000, -800

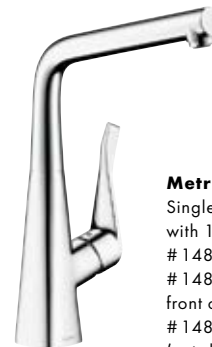

**Metris® 320**  
Single lever kitchen mixer  
with 110°/150°/360° swivel spout  
# 14822, -000, -800  
# 14823, -000 for installation in  
front of a window (not shown)  
# 14888, -000 with shut-off valve  
(not shown)



- Vertical handle position
- Pull-out spray with 2 spray types (normal/shower spray)
- Clear, laminar spray for fewer splashes



- Suitable for installation in front of a window
- Available with device shut-off valve



Talis® Select

# The all-rounder for the modern kitchen

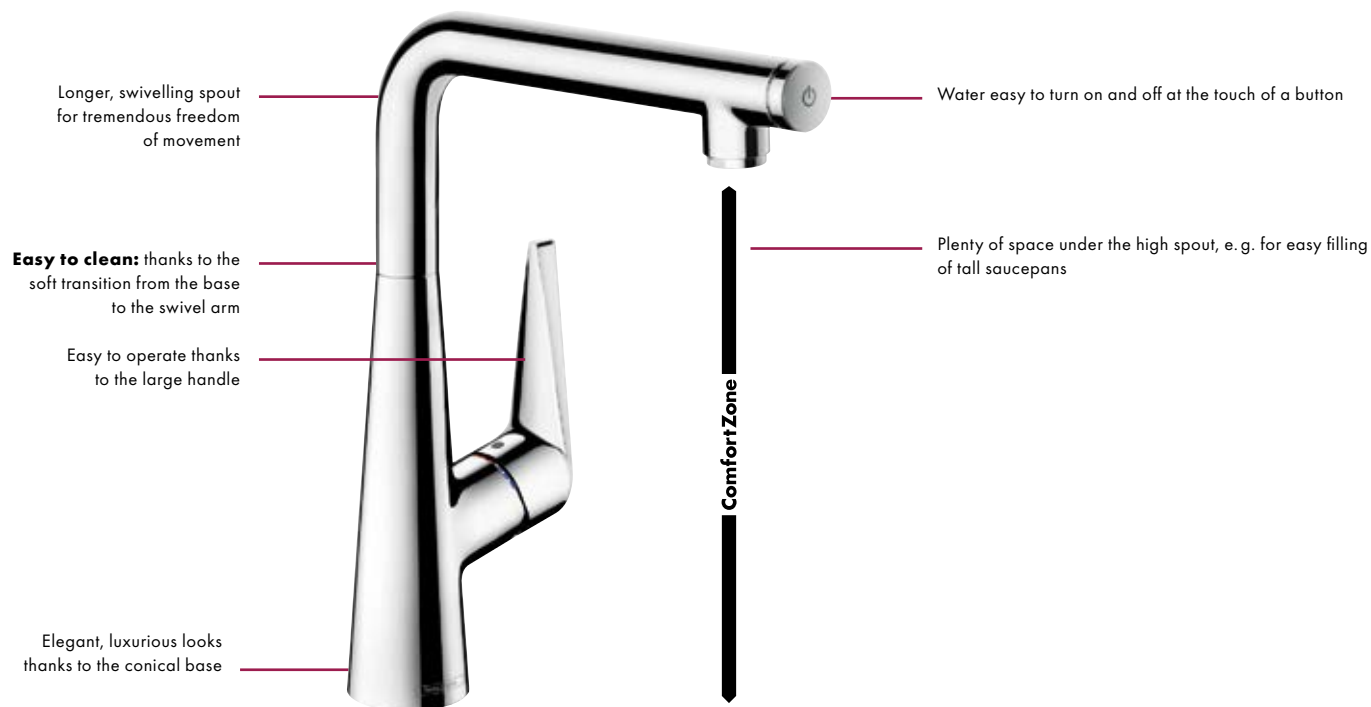

**Versatile:** Even containers that are some distance away are easy to reach and fill without splashing thanks to the Select button and the pull-out hose – even with just one hand.

**Robust:** Whether on the pull-out spray or the 150° swivel spout, the Select button is purely mechanical, which makes it especially robust.



## Advantages and benefits

- Select version with intuitive operation at the touch of a button
- Select technology integrated harmoniously in the slender spout
- Conical basic shape radiates a luxurious elegance
- **Easy to clean:** thanks to the large areas and precise transitions
- Two Select mixer types for individual requirements: with pull-out or swivel spout

## Talis® Select S/Talis® S

NEW



**Talis® Select S 300**  
Single lever kitchen mixer  
with pull-out spout 150°  
# 72821, -000, -800



**Talis® Select S 300**  
Single lever kitchen mixer  
with 110°/150°/360°  
swivel spout  
# 72820, -000, -800

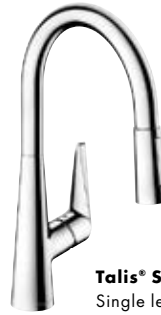

**Talis® S 200**  
Single lever kitchen mixer  
with 110°/150° swivel spout  
# 72813, -000, -800



**Talis® S 280**  
Single lever kitchen mixer  
with 110°/150°/360°  
swivel spout  
# 72810, -000, -800  
# 72812, -000  
for open water heaters



- Pulls out to 50 cm
- Two spray types that are easy to set by means of a switch

## Talis® S Variarc



**Talis® S² Variarc**  
Single lever kitchen mixer,  
two spray types, 150° swivel  
spout possible for window  
installation  
# 14877, -000, -800



**Talis® S² Variarc**  
Single lever kitchen mixer  
with pull-out spout, 150°  
swivel spout possible for  
window installation  
# 14872, -000, -800



**Talis® S² Variarc**  
Single lever kitchen mixer  
with 110°/150°/360°  
swivel spout  
# 14870, -000, -800  
# 14873, -000 for open water  
heaters  
# 14875, -000 with shut-off  
valve (not shown)



**Talis® S² Variarc**  
Single lever kitchen mixer  
with pull-out spray, two spray  
types, 150° swivel spout  
# 32856, -000



## Talis® S



**Talis® S**  
Single lever kitchen mixer  
with pull-out spray, two spray  
types, 150° swivel spout  
# 32841, -000, -800  
# 32842, -000 for open water  
heaters



**Talis® S**  
Single lever kitchen mixer  
with 150° swivel spout  
# 32851, -000, -800  
# 32855, -000 with shut-off  
valve (not shown)



## Talis® Classic



**Talis® Classic**  
Single lever kitchen mixer  
with pull-out spray, two spray  
types, 150° swivel spout  
# 14864, -000 ComfortZone  
210  
# 14863, -000 ComfortZone  
240 (not shown)



**Talis® Classic**  
Single lever kitchen mixer  
with 150° swivel spout  
# 14858, -000



**Focus®**



**Focus® 240**  
Single lever kitchen mixer  
with pull-out spray, two spray types,  
150° swivel spout  
# 31815, -000, -800



**Focus® 260**  
Single lever kitchen mixer  
with 110°/150°/360° swivel spout  
# 31820, -000, -800  
# 31822, -000 for open water heaters  
# 31823, -000 with shut-off valve  
(not shown)



**Focus® 280**  
Single lever kitchen mixer  
with 110°/150°/360° swivel spout  
# 31817, -000, -800



- Pull-out spray with 2 spray types (normal/shower spray)
- MagFit magnetic holder for spray



- Swivel range can be set in three steps (110°/150°/360°)
- Variable handle position (right or left)



**Focus® 160**  
Single lever kitchen mixer  
with 360° swivel spout  
# 31806, -000, -800  
# 31804, -000 for open water heaters  
# 31803, -000 with shut-off valve (not shown)



**Focus® E**  
Single lever kitchen mixer  
with 360° swivel spout  
# 31780, -000  
# 31784, -000 for open water heaters



**Focus® S**  
Single lever kitchen mixer  
with 360° swivel spout  
# 31786, -000  
# 31785, -000 for open water heaters  
# 31783, -000 with shut-off valve  
(not shown)



**Focus®**  
Single lever kitchen mixer  
for wall installation,  
180° swivel spout  
# 31825, -000



**Kitchen shut-off valve**  
# 10823, -000, -800  
to match any Hansgrohe kitchen mixer



**Logis®**

**NEW**



**Logis® 260**  
Single lever kitchen mixer  
with 110°/150°/360° swivel spout  
#71835, -000

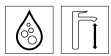

**Logis® 200**  
2-handle kitchen mixer,  
swivel spout 110°/150°/360°  
#71280, -000

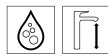

**Logis®**  
Single lever kitchen mixer  
for wall installation,  
180° swivel spout  
#71836, -000



**Logis® 160**  
Single lever kitchen mixer  
with 360° swivel spout  
#71832, -000  
#71833, -000 for installation in  
front of a window (not shown)  
#71834, -000 with shut-off valve  
(not shown)  
#71839, -000 CoolStart Eco  
(not shown)



**Logis® 120**  
Single lever kitchen mixer  
with 360° swivel spout  
#71830, -000  
#71831, -000 for open water  
heaters  
#71837, -000 CoolStart Eco  
(not shown)



**Logis® Classic**

**NEW**



**Logis® Classic 200**  
2-handle kitchen mixer,  
swivel spout, 110°/150°/360°  
#71285, -000



**Logis® Classic**  
2-handle kitchen mixer for wall  
mounting, swivel spout 180°  
#71286, -000



**Logis® Classic**  
2-handle kitchen mixer  
for wall mounting,  
swivel spout 180°  
#71287, -000



Hansgrohe kitchen technologies

# Everything that makes excellent kitchen helpers

A kitchen helper should not only be an eye-catcher it should also withstand a lot. After all, a kitchen mixer is used up to ninety times a day. This makes it the most often used device in the kitchen. That is why we make every single

kitchen mixer exclusively from top quality materials – and fit them with technical highlights. This means: From the peeler to the gourmet, from the dishwasher to the five star chef – Hansgrohe kitchen mixers are a pleasure

to all. No matter who is turning on the tap: Here is where know-how quality, functionality and design come together. This makes our kitchen mixers competent helpers at the sink that will convince even the most discerning of customers.



**Quality made by Hansgrohe:** High quality materials and the fulfilment of international standards assure buyers that they are purchasing a long lasting quality product.



**MagFit magnetic holder:** Thanks to the MagFit function, the hose slides back almost silently and slots back into place in the middle of the mixer spout.



**Pull-out spray with two spray types:** The pull-out spray also offers two types of spray, normal and shower, which are easy to change between.



**Ergonomic handles:** Long flat handles for ease of control.



**Swivel function:** The mixers offer either a limited swivel range (110°/120°/150°) or all-round freedom of movement (360°).



**Pull-out spray/spout:** The pull-out spray and the pull-out spout extend the range at the sink.



**ComfortZone:** The ultra high spout offers plenty of space and is ideal for filling large containers and pots.



**Select Button:** Select technology ensures that using it is easy: a simple click is all it takes to stop and start the water flow. As easy as ABC with an elbow or the back of a hand – so the mixer stays clean.



**Vertical handle position:** Installation is possible even when there is only little room between the mixer and wall. Plus: Hot water flows at the vertical handle out of the reach of children's hands.



**Separation of spout and control unit:** The handle can be positioned flexibly, around the sink in the desired location.



**Variable handle positioning:** The handle can be installed on the left or right, as preferred.



**Stainless steel look PVD:** Stainless steel look surfaces are made with PVD technology and are particularly resistant to wear and scratches.



**QuickClean:** It is very difficult for limescale to take hold on the elastic disc and if it does, it can easily be rubbed away.



**Fold-down function for window installation:** Ideal for installation in front of a window; simply lift the mixer up when required and lay it down.



**Ceramic or joystick cartridge with Boltic handle lock:** Thanks to the specially hardened plastics, the joystick, M1 and M2 cartridges help to ensure the mixer has a long functional life. The wedge-shaped control lever of the Boltic handle prevents the handle wobbling in use.



**PEX hoses:** The PEX hoses are temperature-resistant and neutral in taste and odour.



**Easy installation:** Flexible connections and the integrated stabilisation plate for thin-walled stainless steel sinks make it easier to install the mixer, and guarantee safe results.



**QuickConnect for pull-out spray hoses:** Thanks to the QuickConnect function, the hoses are particularly easy to fit.



**Kitchen shut-off valve:** Available as an option in the same design as any Hansgrohe kitchen mixer for external device shut-off, such as dishwashers.



**Five year guarantee:** You can trust Hansgrohe quality. This is confirmed by the voluntary five-year warranty.

# COMPANY

---

**Ideas with water:  
Hansgrohe has been a step  
ahead of its time since 1901**



The Hansgrohe company

# The love of water lies in our family

Hans Grohe was a pioneer, constantly looking to create new innovations, he was not satisfied with anything less than groundbreaking. In a time when initial ideas were being aired for private home bathrooms and the daily shower was still utopian, he was already developing the first showerheads. He therefore set new standards in the bathroom – far beyond the borders of the Black Forest. Now with branches and subsidiaries in

44 countries on all continents and global product availability, the Hansgrohe brand is seen to be one of the few global players in the bathroom industry. Now as then, the family company is producing predominantly in Schiltach and Offenburg – an acknowledgement to “made in Germany” and at the same time an expression of the values lived at Hansgrohe. One of the most important values is that of social responsibility. The

Hansgrohe Group is therefore one of the sector’s pioneers in the arena of sustainability and environmental protection. This is reflected in water and energy saving products as well as in sophisticated recycling systems, environmentally friendly production technologies, global environmental protection projects and information on the sustainable handling of the resource water.



Hans Grohe was still young when he founded the company in 1901



Hans Grohe with his son Klaus, 1937



Klaus Grohe with his sons Richard and Philippe, 2013



Shower history at Hansgrohe

# Milestones of shower technology

From the trickling apparatus to the convenient spray change at the push of a button: Since 1901, the inventions from the Black Forest thinktank have been shaping the

bathroom landscape all over the world. Many products, concepts and solutions developed and designed at Hansgrohe have given fresh impetus to the international bathroom industry.

Some have written bathroom, perhaps even cultural, history. Such a success story motivates us to constantly stay ahead of the times.



**1928**

First hand shower with white porcelain handle.

**1968**

Selecta®

Selecta hand shower with continuously adjustable shower spray and glass look.

**1974**

Tribel®

First design award winning hand shower in many colours and with three spray types.

**1976**

Mistral®

First hand shower with rotating massage spray.

**1986**

Aktiva®

First hand shower with anti-limescale function QuickClean.

**1987**

Mistral® Eco

New technology with up to 50% water savings.



**1993**  
Joco®

First cartoon design hand shower for children.

**1999**  
Aktiva® A8

2-shell hand shower with internal flow structure and threefold anti-limescale function.

**2003**  
Raindance®

First hand shower with XL showerhead and Whirl spray.

**2004**  
Raindance® Air

First hand shower with AirPower technology.

**2009**  
PuraVida®

Pioneering design language with DualFinish in white/chrome; easy spray change at the push of a button.

**2011**  
Raindance® Select

First Raindance hand shower with Select technology for spray changes

**2012**  
Raindance® Select

First hand shower with two full rain sprays, changed by Select.

History of Hansgrohe mixers

# Revolutions in mixer history

A Hansgrohe mixer is so much more than just a tap. It is always a piece of future for the bathroom. Hansgrohe added highlights in technology and form with its very first mixer, back in 1981. This was followed by numerous other innovations and inventions, and the company set standards in design and functionality – which is confirmed by numerous awards. Of course, this success is also a commitment. Which is why Hansgrohe does everything it can to introduce further epochs in the bathroom history. Hansgrohe has always stood for innovation.



**1981**  
ALLEGROH

The first mixer with the new lever handle, swivel spout and innovative ball mix technique.

**1985**  
Uno

First single lever mixers in red, white, grey and yellow – winners of several design awards.

**1997**  
Boltic

Patented handle lock protects against handle wobbles – even after years.

**2001**  
iBox® universal

First and only basic set for all standard and thermostat solutions – a revolution in concealed installation.

**2002**  
Talis® S

The slender, sophisticated lines bring a new simplicity into the bathroom.



**2005**

World of Styles

Two new style worlds: Elegance – circular, rounded and organic shapes. And Style – clear, minimal and flat.

**2007**

EcoSmart

New, environmentally friendly technology; Hansgrohe mixers only use 5 l/min as standard.

**2009**

PuraVida®

Pioneering design with DualFinish in white/chrome; international award winner thanks to the sculptural looks and technical features.

**2011**

ComfortZone

Various spout heights provide greater freedom of movement in the bathroom.

**2012**

CoolStart

User-friendly, energy-saving technology where only cold water flows when the handle is in the central position.

**2015**

Talis® Select

First basin mixer with Select technology. Water is turned on and off at the touch of a button.



Award for outstanding design

# Perfected water pleasure also means for us: Perfectly shaped

To us, design is not a matter of taste, but an attitude – even a passion. Accordingly, international acclaim has been a constant source of joy to us: Hansgrohe SE with its Hansgrohe and Axor brands took eleventh

place in the 2015 iF rankings and is therefore number one on the bathroom industry. Over 450 awards make us one of the highest award winners on the sanitary market. However, design is never an end in itself, but always an

expression of equality between form and function. In the search for the most intelligent solution, we create showers and mixers whose extraordinary quality is a never ending source of pleasure.



**Raindance®**  
Hand shower



2003 2003 2004



**Raindance® S 150**  
Hand shower



2005 2006 2006



**Raindance® Royale 350**  
Overhead shower



2005 2005 2006



**Raindance® Rainmaker®**  
Overhead shower



2005 2006



**Metris® S**  
Electronic basin mixer



2006 2007



**Focus® S**  
Single lever basin mixer



2006 2007



**Raindance®**  
Hand shower



2007



**Talis® E2**  
Single lever basin mixer



2007 2008



**Croma® 100 Multi**  
Hand shower



2007 2008



**Raindance® Rainfall® 240**  
Overhead shower



2007 2008 2009



**Talis® S2**  
Single lever basin mixer



2007 2007 2008



**Raindance® Connect S 240**  
Showerpipe



2007 2007 2008 2010



**Croma® 100**  
Showerpipe



2008



**Raindance® S 150 / Raindance® Unica® S**  
Set



2008 2009



**Ecostat® E**  
Bath thermostat



2008 2009



**Talis® Classic**  
Single lever basin mixer



2008 2009



**Crometta® 85 Green**  
Hand shower



2008 2010



**PuraVida® 240**  
Single lever basin mixer



2009 2009 2010 2011



**PuraVida® 400**  
Overhead shower



2009 2010



**PuraVida® 150**  
Hand shower



2009 2009 2010



**PuraVida® 110**  
Single lever basin mixer



2009 2009 2010



**RainBrain®**  
Shower control



2009 2012



**Focus® E2**  
Single lever basin mixer



2010 2011



**Raindance® E 420**  
Showerpipe



2010 2011 2013



reddot design award



Focus Open Silber 2012

**DESIGN PLUS**

powered by: **ISH**



**Raindance® 240**  
Showerpipe



2010 2010 2011



**Raindance® E 420**  
Overhead shower



2010 2012



**PuraVida®**  
Electronic kitchen mixer



2011 2012



**Raindance® Select S 150**  
Hand shower



2011 2012 2012



**Raindance® Rainfall® 180**  
Overhead shower



2012



**PuraVida®**  
Electronic basin mixer



2012



**Focus® 240**  
Single lever basin mixer



2012



**Focus®**  
Electronic basin mixer



2012 2012



**PuraVida® 225**  
Single lever basin mixer



2012 2012



**Metris®**  
Product family Single lever basin mixer



2012 2012



**Talis®**  
Product family Single lever basin mixer



2012



**Focus®**  
Product family Single lever basin mixer



2012



**Raindance® Select E 120**  
Hand shower



2013



**Raindance® Rainfall® Stream 150 1jet**



2013



**Raindance® Lift Showerpanel®**



2013



**ShowerSelect®**  
Thermostat product family



2013 2014 2014



**ShowerSelect® Select 300**  
Thermostat



2013 2014



**Raindance® Select S 120**  
Hand shower



2014



**Metris® 320**  
Single lever kitchen mixer



2014



**Logis®**  
Product family Single lever basin mixer



2014 2014



**Metris® Select 320**  
Single lever kitchen mixer



2014



**Talis® Select S**  
Product family Select basin mixer



2015 2015



**Rainmaker® Select**  
Showerpipe



2015 2015



**ShowerSelect® Glas**  
Thermostat product family



2015 2015



**Crometta® 100**  
Product family hand shower



2015



Manfred Dorn, Tom Schönherr, Andreas Haug, and Harald Lutz (from left)

## Winner of many awards: Phoenix design

This team has been shaping the face of Hansgrohe for many years: Andreas Haug, Tom Schönherr, Manfred Dorn and Harald Lutz. Their yardstick of successful design is the satisfaction of the people who use their products. Although this creative team prefer to work in the background, they are nevertheless overjoyed at the many awards their design workshop has received.

Photo: Phoenix Design

International projects

# The world is our home



All over the world, developers and investors work hand in hand with architects and planners on sophisticated projects. They are constantly in need of intelligent and aesthetically appealing solutions for handling the essential element water. The mixers,

showers and bathroom collections from the Black Forest lend top addresses that definite extra design and comfort: in impressive hotels and public buildings, in private residences and royal palaces, in exclusive sports clubs and in cruise ships and luxury yachts. You will find

further inspiring examples of this on our innovative bathroom planning platform:

<http://pro.hansgrohe-int.com/references>



Hotel Vander Urbani Resort, Ljubljana  
Hansgrohe products:  
PuraVida® basin mixer 200, PuraVida® bath mixer,  
PuraVida® baton shower

Photos: Miran Kambic



Unique Design Hotel Lone, Rovinj  
Hansgrohe products:  
Talis® basin mixer, Talis® bath mixer,  
Croma® 100 hand shower

Photos: 3LHD



Hotel JW Marriott Santa Fe, Mexico City  
 Hansgrohe products:  
 PuraVida® basin mixer, PuraVida® bath mixer,  
 PuraVida® baton shower

Photos: Hotel Marriott Santa Fe



Neue Hofgärten, Ludwigshafen  
 Hansgrohe products:  
 Metris® bath mixer, Croma® 100 Vario/  
 Porter 'S set

Photos: Hansgrohe Esch



Hotel SS Hilton, Gdańsk  
 Hansgrohe products:  
 Talis® 80 basin mixer, Raindance® S 120 Air/  
 Unica® 'S Puro shower set, EcoStat® S thermostat

Photos: Jan Wójcikiewicz



Stamford Residences, Sydney  
Hansgrohe products:  
Focus® 100 basin mixer, Focus® bath spout

Photos: Stuart Scott



Hotel Saint Regis, Roma  
Hansgrohe products:  
Raindance® E 420 Air Showerpipe,  
Raindance® Classic 300 overhead shower,  
Raindance® E 120 Air hand shower

Photo top: Matthias Hamel Fotografie  
Photo left: Enrico Maria Santoni

Al Matrook Tower, Bahrain  
 Hansgrohe products:  
 Metris® 3-hole bath mixer for the tub rim

Photos: The Domain Bahrain



Private bathroom Christina Obergföll, world champion javelin throw 2013  
 Hansgrohe products:  
 ShowerSelect® finish sets, Raindance® Rainfall®,  
 Raindance® Select E 120 hand shower, Metris®  
 basin mixer, Metris® bath mixer

Photos: Peng Chen



Cruiselinier Norwegian Breakaway  
 Hansgrohe products:  
 Metris® basin mixer, Metris® 3-hole bath mixer,  
 Raindance® S Showerpanel®

Photo top: Meyer Werft  
 Photo left: Ingrid Fiebak-Kremer

## Technologies



Switches over to a different shower or spray type in moments, and provides pleasure at the touch of a button.



Reduces the flow rate to save water and energy. For long-lasting pleasure.



Combines water with a generous amount of air. For a soft, splash-free water spray and rich, full shower drops.



Limescale deposits are simply wiped away by rubbing a finger over the flexible silicone jets.



Distributes the water over the large spray face envelops the whole body in drops of well-being.



Defines the useable area between washstand and mixer. Something to suit every customer.

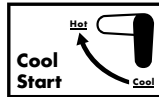

Cold water starts to flow when it is opened in the basic setting. You consume hot water only when you need it.

## Spray modes



Rain spray over the entire area of the spray face for large-scale showering pleasure.



Perfect for rinsing shampoo out of your hair.

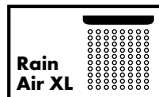

The especially large spray face envelops your whole body with soft drops.



Gentle shower rain with air-enriched drops.



The ultra-soft drops are a delight for the skin and soul.



An intensive water spray that activates and refreshes.



The most powerful of all Rain sprays – for a refreshingly powerful showering experience.

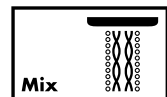

The harmonious combination of gentle shower drops and dynamic spray.

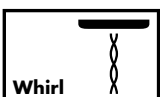

A concentrated massage spray.

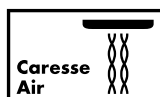

Provides fresh energy after a challenging day: The feel good, revitalising massage spray.



Strong, pulsating massage spray.



A flat, targeted jet for partly refreshing shower pleasure.



A powerful surge spray for the feeling of standing alone in a waterfall. Every day.



Parallel jets of large sparkling water drops right down to the floor for the same showering experience on all body sizes.

## Surfaces

Order numbers specifying a surface finish are (#) eight digits long, for example 28500, -000=Chrome

**-000 Chrome**  
**-400 White/chrome**  
**-450 White**

**-600 Black/chrome**  
**-800 Stainless steel optic**

Please bear in mind that we can present only a selection of our products in this sales manual. Our full range can be found at <http://pro.hansgrohe-int.com>.

**Find out more about the Hansgrohe world at <http://pro.hansgrohe-int.com>**



### **Experience Hansgrohe products interactively**

The iPad version of the end customer catalogue can be found at <http://appstore.com/hansgroheshowroom>



### **Planning with Hansgrohe@home**

Use this app to show your customers how good a Hansgrohe mixer will look in their home, virtually.

iTunes: <http://appstore.com/hansgrohehome>

Google Play: <http://play.google.com/store/search?q=hansgrohe+se>



### **Savings with Hansgrohe**

All you need to know about how Hansgrohe helps to save water and energy can be found at [www.hansgrohe-int.com/savings-calculator](http://www.hansgrohe-int.com/savings-calculator) or, on mobile devices, at <http://m.pro.savings.hansgrohe-int.com>



This catalogue has been produced with as much care for the environment as possible. You can also do your bit for the environment by passing this catalogue on to others when you have finished with it or else recycling it.



[www.facebook.com/hansgrohe](http://www.facebook.com/hansgrohe)



[www.twitter.com/hansgrohe\\_pr](http://www.twitter.com/hansgrohe_pr)



[www.youtube.com/hansgrohe](http://www.youtube.com/hansgrohe)

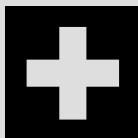

## Hansgrohe professional support:

### The Hansgrohe Master Service

Experienced master sanitary fitters provide sound knowhow for your technical questions on any product in the Hansgrohe range. Service and spare parts are supplied over the fastest route.

#### Service hours:

Mon–Fri: 7:00 am to 06:00 pm  
 Phone: +49 7836 51-1282  
 Fax: +49 7836 51-1440  
 Email: [info@hansgrohe.com](mailto:info@hansgrohe.com)

### Hansgrohe availability guarantee

All spare parts are available for ten years following purchase. You can then rest assured, also for projects completed in the past.

### Hansgrohe quality warranty

The highest quality is an elementary constituent of the Hansgrohe corporate philosophy. For this reason, we offer consumers a voluntary manufacturer's warranty of five years on our products.

Details at [www.hansgrohe-int.com](http://www.hansgrohe-int.com).

### Hansgrohe Aquademie

The Aquademie is our adventure centre on all aspects of water. Learn everything about bathroom and bathing history at our museum. Our exhibition shows you how international designers turn bathrooms into real feel good oases. See for yourself how innovative technologies put genuine pleasure into water savings. Or enjoy pure showering and water fun in our Showerworld, Germany's largest bathroom.

#### Opening hours:

Mon–Fri: 7:30 am to 07:00 pm  
 Sat–Sun: 10:30 am to 04:00 pm  
 Admission free of charge. For Showerworld: Appointment and swimwear required.

**Headquarters** – Hansgrohe SE · P.O. Box 1145 · D-77757 Schiltach · Tel. +49 7836 51-0  
 Fax +49 7836 51-1300 · [info@hansgrohe.com](mailto:info@hansgrohe.com) · [www.hansgrohe-int.com](http://www.hansgrohe-int.com)

**Argentina** – Hansgrohe S.A. · Av. del Libertador 14.323 · Martínez · B1640APB · Buenos Aires  
 Tel. +54 11 4733 2400 · Fax +54 11 4733 2499 · [info@hansgrohe.com.ar](mailto:info@hansgrohe.com.ar) · [www.hansgrohe.com.ar](http://www.hansgrohe.com.ar)

**Australia** – Hansgrohe Pty Ltd · Level 1 · 123 Camberwell Rd · East Hawthorn · Victoria 3123  
 Tel. +61 3 9811 9971 · [info@hansgrohe.com.au](mailto:info@hansgrohe.com.au) · [www.hansgrohe.com.au](http://www.hansgrohe.com.au)

**Central America & The Caribbean** – Hansgrohe SE Regional Office  
 Obarrio, 58 Street, PH Office One, No. 803 · Panama, Republic of Panama  
 Tel. + 507 263 1343 · [marketing.cca@hansgrohe.com](mailto:marketing.cca@hansgrohe.com)

**Denmark** – Hansgrohe A/S · Jegstrupvej 6 · DK-8361 Hasselager · Tel. +45 86 287400  
 Fax +45 86 287401 · [info@hansgrohe.dk](mailto:info@hansgrohe.dk) · [www.hansgrohe.dk](http://www.hansgrohe.dk)

**Estonia** – Hansgrohe Eesti esindaja Andrus Asavi · Maealuse 2/1 · 12618 Tallinn  
 Tel. +372 53 32 92 55 · Fax +372 56 00 00 55 · [info@hansgrohe.ee](mailto:info@hansgrohe.ee) · [www.hansgrohe.ee](http://www.hansgrohe.ee)

**Latvia** – Hansgrohe Latvijas pārstāvniecība · SIA Aqua Studio · Raiņa iela 14 · LV-3913 Iecava  
 Tel. +371 29 22 90 29 · Fax +371 63 94 22 51 · [info@hansgrohe.lv](mailto:info@hansgrohe.lv) · [www.hansgrohe.lv](http://www.hansgrohe.lv)

**Lithuania** – Santoza · Ulonų g. 5 · LT-08240 Vilnius · Tel. +370 5 2043291  
 Fax +370 5 2043293 · [info@hansgrohe.lt](mailto:info@hansgrohe.lt) · [www.hansgrohe.lt](http://www.hansgrohe.lt)

**Netherlands** – Hansgrohe · Handelsweg 45 · 1525 RG Westknollendam  
 Tel. +31 75 6461400 · [info@hansgrohe.nl](mailto:info@hansgrohe.nl) · [www.hansgrohe.nl](http://www.hansgrohe.nl)

**Romania** – Hansgrohe SE · P.O. Box 1145 · D-77757 Schiltach · Tel. +49 7836 51-0  
 Fax +49 7836 51-1300 · [info@hansgrohe.ro](mailto:info@hansgrohe.ro) · [www.hansgrohe.ro](http://www.hansgrohe.ro)

**Sweden** – Hansgrohe AB · Svagatan 2B · S-416 68 Göteborg  
 Tel. +46 31 216600 · Fax +46 31 190103 · [info@hansgrohe.se](mailto:info@hansgrohe.se) · [www.hansgrohe.se](http://www.hansgrohe.se)

