

**Hansgrohe**  
Technical information

Planning and installation -  
now including the new ShowerSelect® finish sets

# iBox® universal



**UNIDOMO®**

**Web:** [www.unidomo.de](http://www.unidomo.de)

**Telefon:** 04621- 30 60 89 0

**Mail:** [info@unidomo.com](mailto:info@unidomo.com)

**Öffnungszeiten:** Mo.-Fr. 8:00-17:00 Uhr

**VIESMANN**

**Buderus**

 **Vaillant**

**WOLF**

 **JUNKERS**  **BOSCH**

 **remeha**

 **DAIKIN**

**ROTEX**

a member of DAIKIN group



-  Individuelle Beratung
-  Kostenloser Versand
-  Hochwertige Produkte

-  Komplettpakete
-  Über 15 Jahre Erfahrung
-  Markenhersteller

# One for all ...

Since its introduction, the iBox universal has been the first and only basic set for Hansgrohe and Axor concealed manual and thermostatic solutions. Its features are just as varied as the number of possible uses. The iBox universal creates more space, freedom of movement and planning freedom in the bathroom - and is quick and easy to install. So it's no wonder, then, that the iBox universal has quickly become a firm favourite of the bathroom sector.

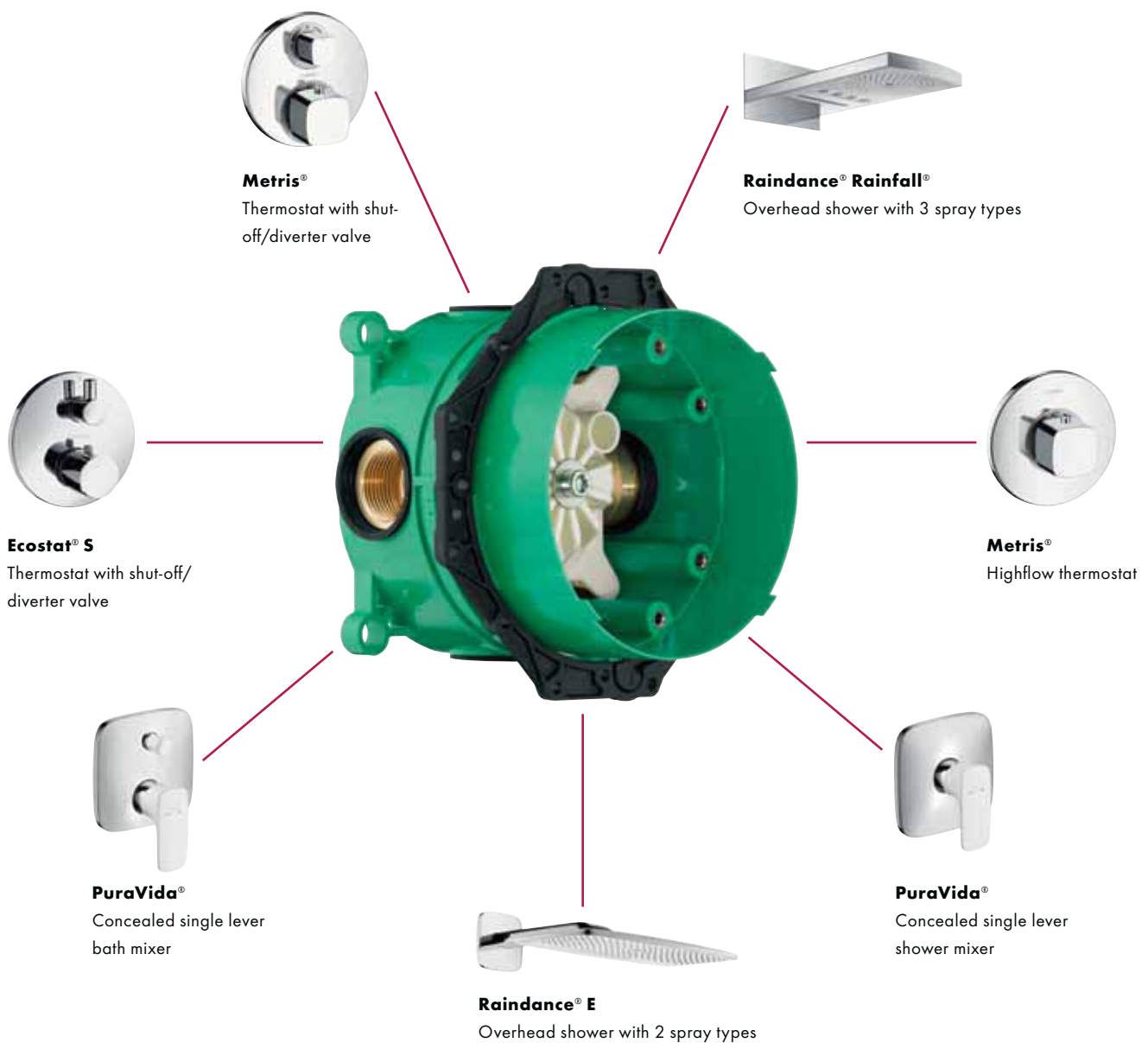

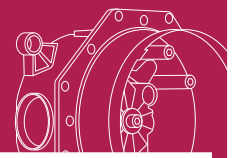

**iBox® universal**

The concealed system -  
also for ShowerSelect

## ... and select your Shower Pleasure

The iBox universal is the flexible concealed solution, which is also suitable for the latest milestone in Hansgrohe's history: **Select technology**. This provides greater shower pleasure from hand and overhead showers and surface-mounted thermostats because a simple touch of a button is all it takes to switch the mixer on and off, select or change the function or change the spray type. The innovative Select control concept is also available as a concealed solution in combination with the iBox universal using the new ShowerSelect finish sets.

Select your shower pleasure when:

- updating an bathroom with iBox universal as a basic set
- building a new house
- renovating or modernising



iBox® universal basic set

Functions block

ShowerSelect® finish set

**Like all Hansgrohe concealed solutions, the new ShowerSelect finish sets are easy to fit to the iBox universal.**

## Concealed – the attractive way to fit a mixer

---

With the iBox universal, the mixer technology is concealed in the wall. This not only looks good, but also creates more space and so adds to the shower pleasure. Another feature is the flexibility of the design and system. The iBox universal can be installed before a shower system is chosen. As the basic set for any Hansgrohe concealed solution, it can be changed and upgraded at any time.



### **Surface-mounted installation**

With a surface-mounted installation, the function unit is entirely in front of the wall – i.e. on the plaster. The disadvantage is that it takes up more space, which reduces the freedom of movement when showering.



### **Concealed installation**

With concealed installation, the base unit is housed within the wall, i.e. behind the plaster. Mixers and shower finish sets from various Hansgrohe and Axor ranges can be fitted to it.

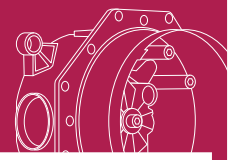

**iBox® universal**

Advantages of concealed assembly and iBox universal

# iBox® universal: all-round appeal

The iBox universal is the first choice for concealed installation. See for yourself over the following pages just what the iBox universal has to offer you and your customers.

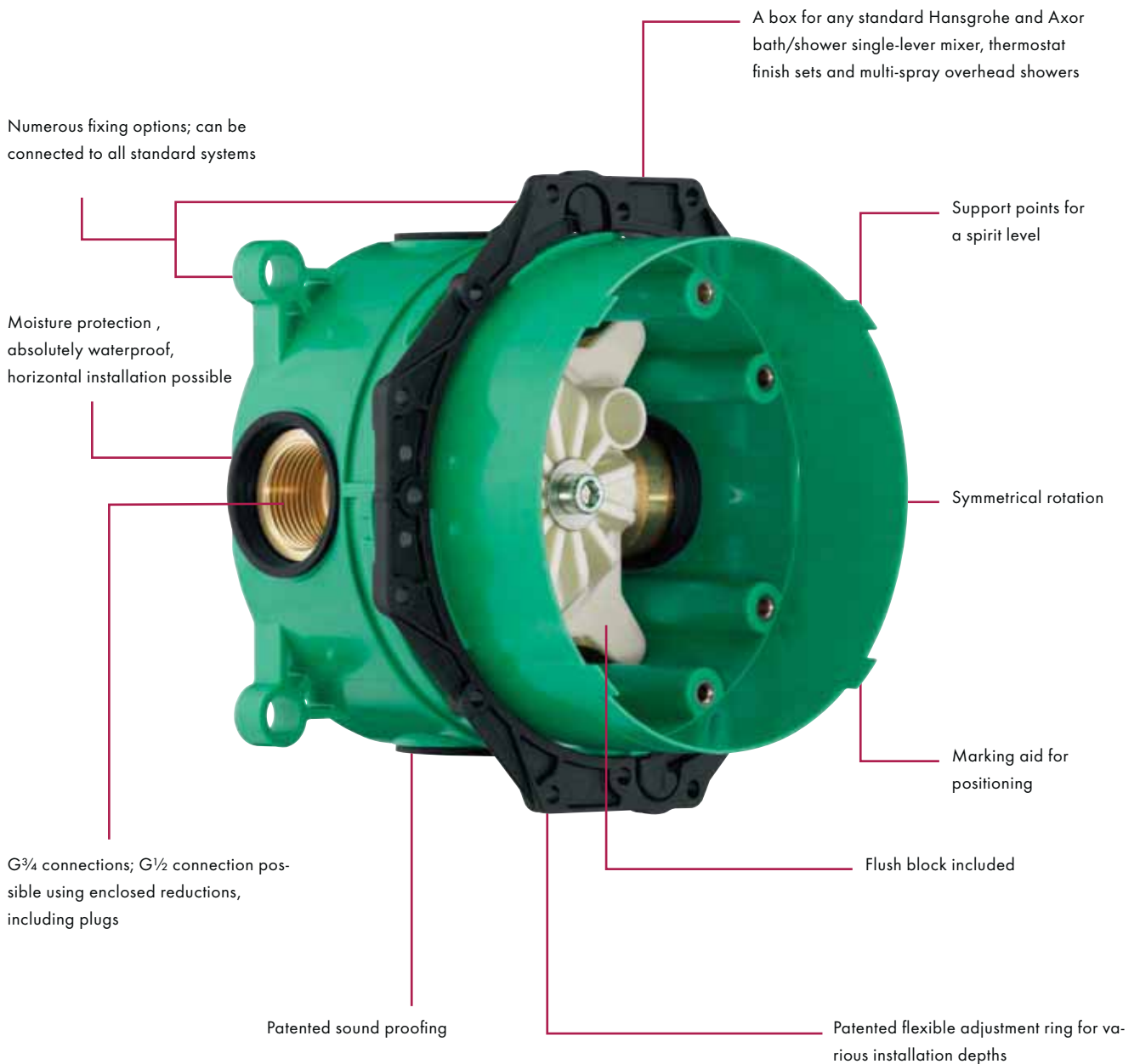

# The many advantages of the iBox® universal

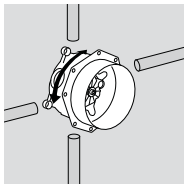

## Rotationally symmetrical installation

- Symmetrical structure; all connections are equal.
- It is important that the cold water is connected on the right and the hot water on the left.
- When used as a bath mixer, the lower outflow takes priority.
- When the iBox universal is used as a shower mixer, either the upper or lower outflow can be connected.

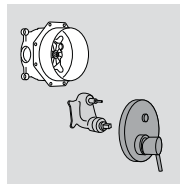

## Safe and economical

- The basic set contains just the connection block.
- The valuable fitting aid is delivered and installed later, together with the finish set.
- Prevents problems like theft, dirt and frost damage occurring during the building phase and expensive warehousing becomes unnecessary.

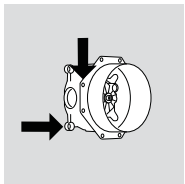

## Multiple installation options

- Coordinated with all current installation systems and all types of connections and fittings.
- Patented flexible adjustment ring.
- Mounting options at two levels and G $\frac{3}{4}$  connections for universal installation possibilities.
- Also suitable for thicker walls and dry wall installations as well as for pre-fabricated housing systems.

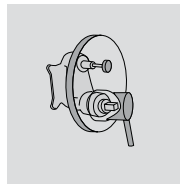

## Integrated safety combination

- When installing a concealed single lever bath mixer with integrated safety combination – together with an Exafill bath filler with waste and overflow set – a non return valve becomes unnecessary. This reduces installation costs as well as the number of functional parts inside the wall.

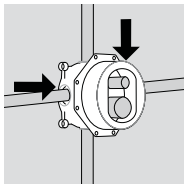

## Excellent protection against humidity

- This will protect against splashing water and moisture coming from any direction.
- Seals on all four connections and the supporting collar.

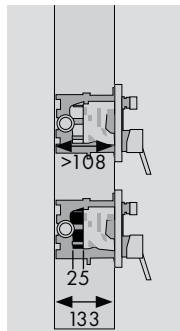

## Solutions for walls that are either very deep or very shallow

- If the iBox universal sits too deep in the wall, the basic unit extension is fitted between the connector and the function block.
- The extension set ensures safety right up to the wall and keeps the walls free from dampness.
- The iBox universal standard basic set has been made flatter and is now even better suited for walls with limited installation depths.

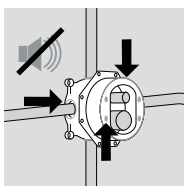

## Low noise level

- The brass body rests on seals, preventing sound from the water-conducting parts from being transferred through the wall.
- The supporting collar is screwed to the iBox universal housing and not to the function block, which prevents sound from being transferred through to the tiles.

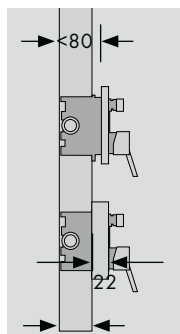

## Collar extension

- Thanks to the extension, even limited installation depths are no longer a problem.
- The extension collar makes it possible to install the iBox universal despite the lack of depth.

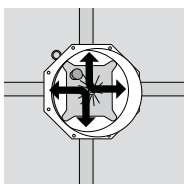

## Easy rinsing

- The rinse block supplied with the iBox universal can be mounted in different positions. This makes it easy to flush the pipes through to where they finish at the wall.

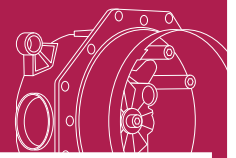

**iBox® universal**  
Strengths and benefits

## Flexibility that benefits everyone

Sine the launch in 2001, Hansgrohe's iBox universal has been setting standards in the bathroom. As a veritable all-rounder, it is designed to go with any standard installation system, connection and fitting. It also offers unique advantages that benefit you, whether you are a retailer, installer or wholesaler for project business.

### How you as a retailer benefit from the iBox® universal:

- You only need one basic set for 16 function solutions
- Over 200 Hansgrohe and Axor finish sets fit on the iBox universal
- You only have to keep one basic set in stock, which reduces storage space and costs
- The iBox universal fits on lots of installation systems, connection items and fittings
- Durability guaranteed by a tried-and-tested, safe technical standard
- You save time, because the iBox universal is quickly and easily installed
- The iBox is an innovative success factor: proven and consistently developed for over 12 years

### How you benefit from the iBox® universal in your project business:

- The iBox universal offers a high level of flexibility and allows a variety of design options
- Your project planning will be much easier: one base unit will serve for any solution – leaving you with more time to choose the mixer
- The iBox is suitable for use in private or public facilities, and complies with all the main international standards
- Covers any consumer solution with up to 4 functions
- A concealed system that you can rely on – which has been proven millions of times over

### How the iBox® universal benefits consumers:

- More time to choose the mixers
- An attractive bathroom, as all the technology hidden behind the wall
- Greater freedom of movement when showering
- Easy to replace with new mixers when renovating
- The safety of a solution that has been proven for over 12 years



# The optimum foundation for the new Select technology

The ShowerSelect finish sets for the iBox universal can be used to offer the innovative Select technology, which the consumer controls at the touch of a button. The Select technology delights customers with its design and revolutionary control concept. The focus is on the Select button. A simple touch of a button is all it takes to switch functions on and off or change the spray types. Everything works purely mechanically, which provides long-lasting reliability – and thus permanently satisfied customers.

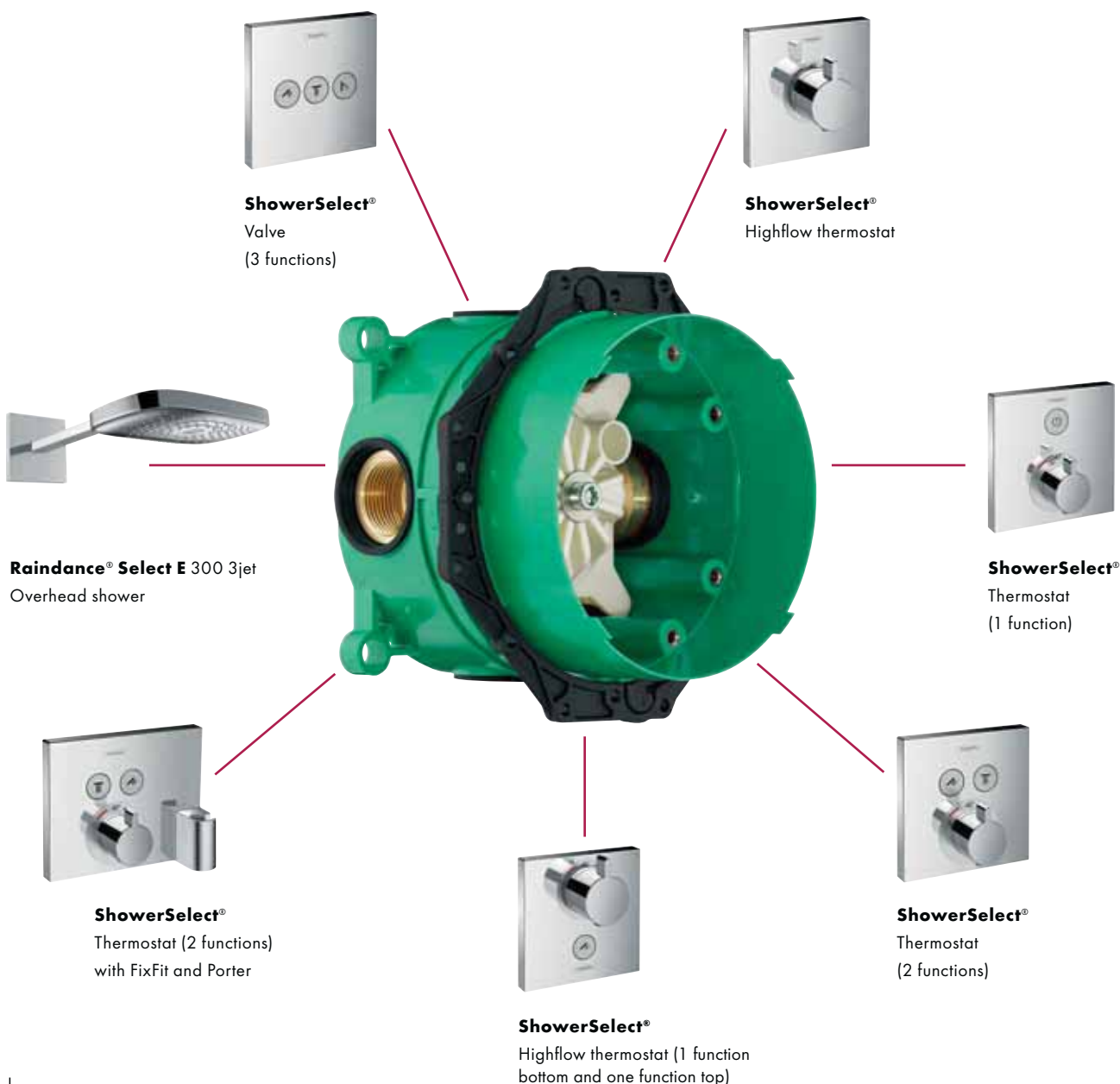

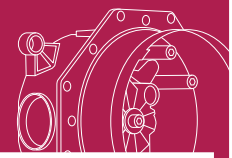

**iBox® universal**  
ShowerSelect design

# ShowerSelect® finish sets: design where everything fits

A geometric shape that blends perfectly with the modern bathroom. Buttons that integrate flush in the overall picture and a control concept that harmonises with the desire for shower pleasure. The new, smart ShowerSelect finish sets appeal for a design that is visually and functionally perfect. So it's practically made for you to help you acquire new customers.

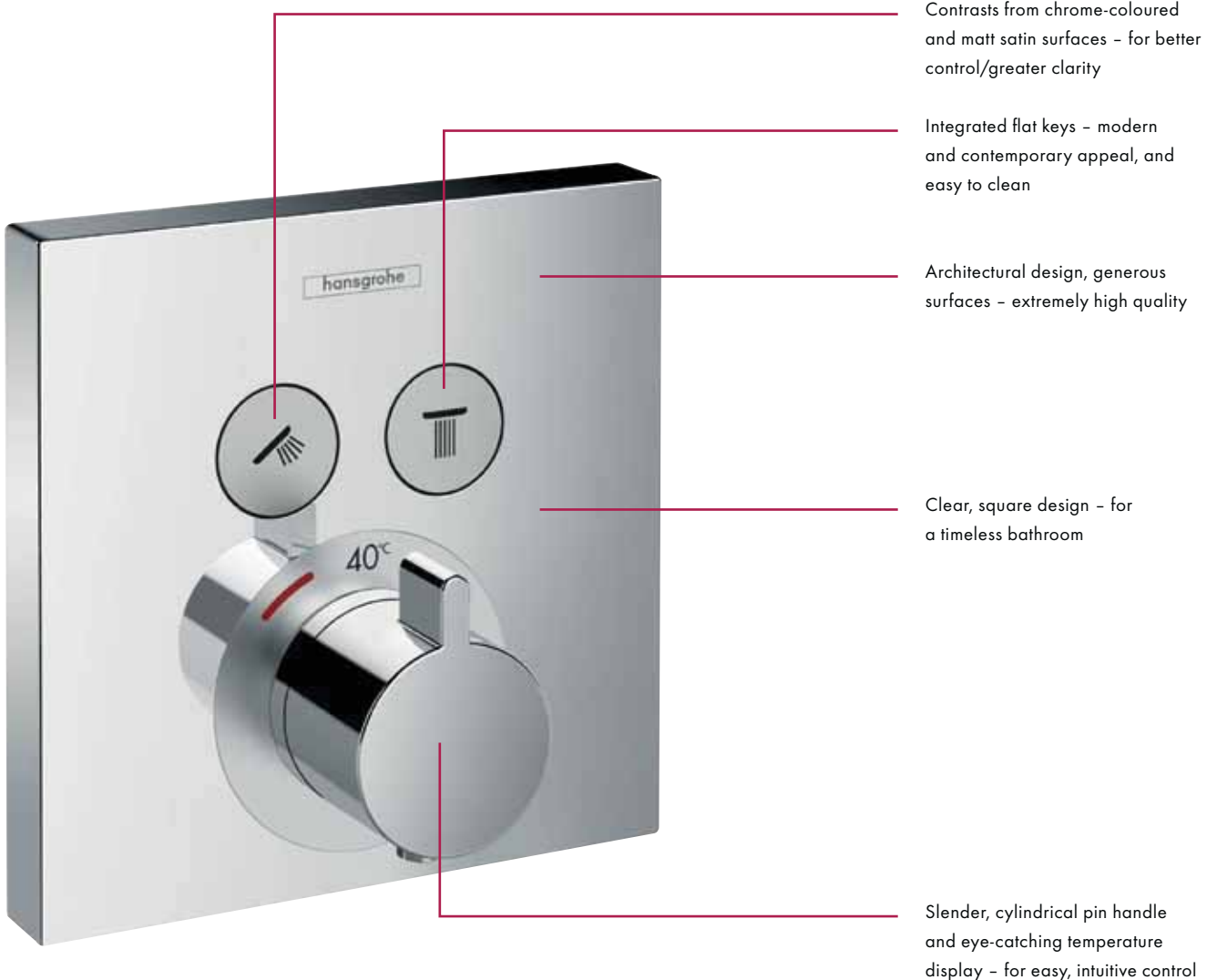

## DESIGN PLUS

powered by: **ISH**



### Award-winning design

The ShowerSelect finish set with its aesthetic appeal and user friendliness was awarded the "Design Plus Award" by the Design Council. The ShowerSelect finish set for 2 functions received the "Bathroom comfort for generations" product award of the ZVSHK, the German Central Association Plumbing, Heating and Air Conditioning, for excellent design for users with restricted mobility.

# iBox<sup>®</sup> universal and ShowerSelect<sup>®</sup>: the new way to control shower pleasure

Form and function go hand in hand with the new ShowerSelect finish sets. From easy-to-use control elements and intuitive handling to easy cleaning: with their many advantages, the ShowerSelect finish sets are perfect for selecting your shower pleasure. Delight your customers with the many advantages of the ShowerSelect finish sets.



#### **Intuitive:**

The Select buttons for intuitive, comfortable control – even for elderly and less able customers.



#### **Clear:**

Easy-to-understand symbols that do not rub off simplify operation even further, and are extremely durable.



#### **Easy to use:**

The protruding button instantly reveals the active functions. Can be controlled using an elbow or fist thanks to the button extension that is included in the box.



#### **User-friendly:**

The desired temperature can be set precisely with the user-friendly handle.



#### **Clean:**

The flush-fit buttons leave a flat surface that is easy to clean.



#### **Attractive:**

The modern rectangular shape blends perfectly with a tiled bathroom.



#### **Economical:**

The easy push-button encourages the user to switch the water off frequently, which helps to save water.



#### **Luxurious:**

The functions can all be set at the same time – for even greater shower pleasure.

# ShowerSelect® – Advantages at the touch of a button

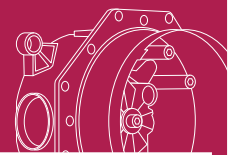

**iBox® universal**  
ShowerSelect advantages

## How you as a retailer benefit from the ShowerSelect® finish sets:

- New, unique products on the market in an attractive and exclusive design
- Additional sales opportunities through the acquisition of new customers
- Complete collection for broad range of applications
- Universal combinations with any Raindance or Raindance Select shower and competitor products
- Easy to install on the well-known concealed iBox universal system, tried and tested since 2001
- High potential in renovations
- Long-lasting thanks to mechanical valves, which means permanently satisfied customers and no complaints
- Direct use possible, as all the required button combinations are included in the box
- Easier installation on 4-function solution

## How you benefit from the ShowerSelect® finish sets in your project business:

- New architectural design in the Hansgrohe concealed range
- Clear, reduced, minimalistic and precise style – for timeless bathroom design
- Attractive price segment
- Safe, easy planning, since all the applications are covered by 1 to 4 functions
- Also suitable for semi-public areas, as thermal disinfection is easily possible

## How consumers benefit from the ShowerSelect® finish sets:

- Geometric-square design, making it suitable for any bathroom and lots of tile types
- Intuitive, easy control at the touch of a button
- Large symbols – for easy handling and clarity
- Safe, visible temperature adjustment thanks to the slender, cylindrical pin handle and eye-catching coloured temperature display
- Fast, inexpensive renovations possible by simply replacing the existing finish sets
- Easy to clean thanks to flush-fit buttons
- Easy to push button helps to save water by encouraging the user to push it
- High level of comfort by simultaneously setting several functions

# The ShowerSelect® finish set range



**ShowerSelect®**  
Thermostat  
for 1 function  
# 15762, -000

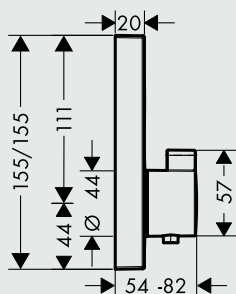

All flow rates without functions.

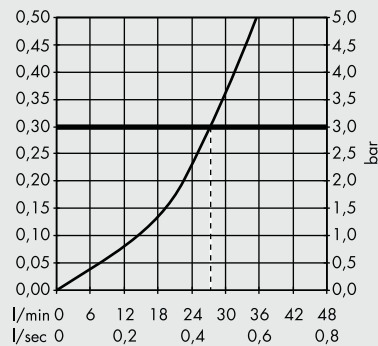

**ShowerSelect®**  
Thermostat  
for 2 functions  
# 15763, -000

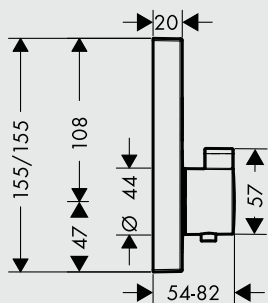

All flow rates without functions.

**Legend**

- ① bottom
- ② top

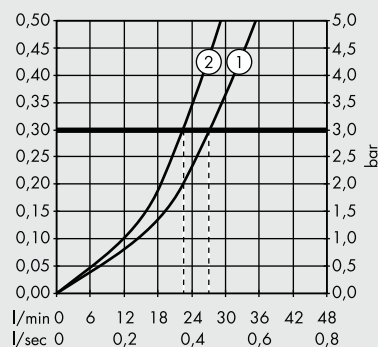

**ShowerSelect®**  
Thermostat  
for 2 functions  
with FixFit and Porter  
# 15765, -000

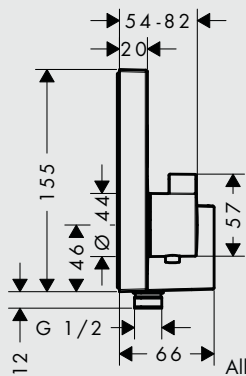

All flow rates without functions.

**Legend**

- ① bottom
- ② top

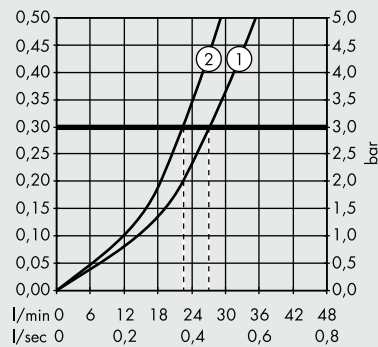

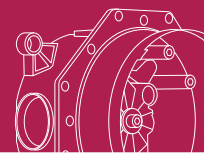

**iBox® universal**  
The ShowerSelect  
finish set range



**ShowerSelect®**  
Valve  
for 3 functions  
# 15764, -000

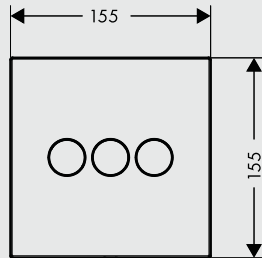

**Legend**

- ① left
- ② top
- ③ right

All flow rates without functions.

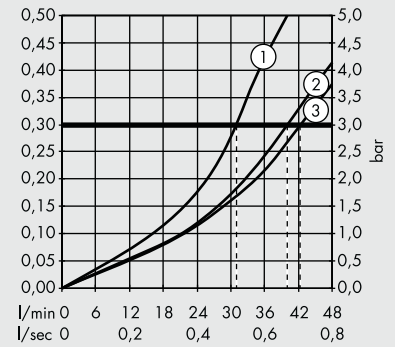

**ShowerSelect®**  
Highflow thermostat  
# 15760, -000

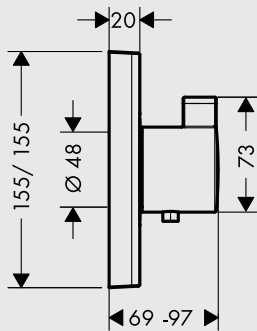

All flow rates without functions.

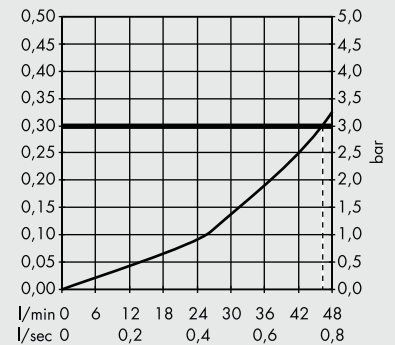

**ShowerSelect®**  
Highflow thermostat  
for 1 function (bottom) and one  
additional function (top)  
# 15761, -000

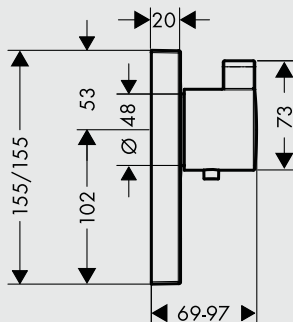

**Legend**

- ① bottom
- ② top

All flow rates without functions.

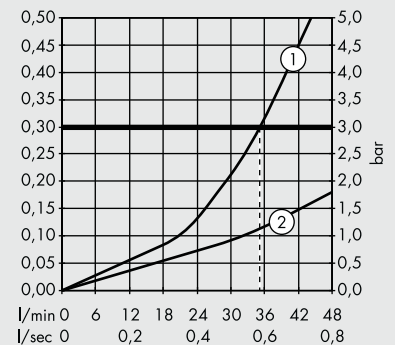

# Possible uses for 1 to 4 functions

## Shower system with 1 function

For instance, overhead **or** hand shower



## Shower system with 2 functions

For instance, overhead **and** hand shower



ShowerSelect thermostat for 1 function



ShowerSelect thermostat for 2 functions

## Other possible installations



Thermostat with shut-off valve



Thermostat with shut-off/diverter valve



Single lever shower mixer



Single lever mixer with diverter



**iBox® universal**

Examples of uses for  
1 to 4 functions

**Shower system with 3 functions**

For instance, overhead shower (2 spray types) **and** hand shower



ShowerSelect valve  
for 3 functions



ShowerSelect Highflow thermostat

**Shower system with 4 functions**

For instance, overhead shower (3 spray types) **and** hand shower



ShowerSelect valve  
for 3 functions



ShowerSelect Highflow thermostat  
for 1 function (bottom) and one  
additional function (top)

**Other possible installations**



iControl shut-off/diverter valve



Highflow thermostat

**Other possible installations**



Trio/Quattro  
shut-off/diverter  
valve



Shut-off valve



Highflow  
thermostat



Shut-off valve



iControl  
shut-off/diverter  
valve



Highflow  
thermostat



Shut-off valve



# Installation 1 function

Ceiling 

## Flow diagram

Hand shower Raindance S 120 3jet  
# 26530000

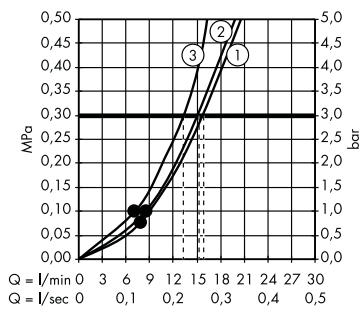

Minimum operating pressure •

## Components

Mixers

- ⓑ iBox universal  
# 01800180  
ShowerSelect thermostat  
# 15762000



Alternative:  
Metris thermostat  
# 31572000

Other alternatives possible.

Showers

- Ⓐ Raindance Select S 120  
# 26530000  
Shower holder Porter S  
# 28331000  
Shower hose Isiflex  
# 28276000
- Ⓒ Hose connection FixFit  
# 27453000
- Ⓓ Waste system Staro 90  
# 60056000

- Legend**
- ⓐ RainAir
  - ⓑ Rain
  - ⓒ Whirl

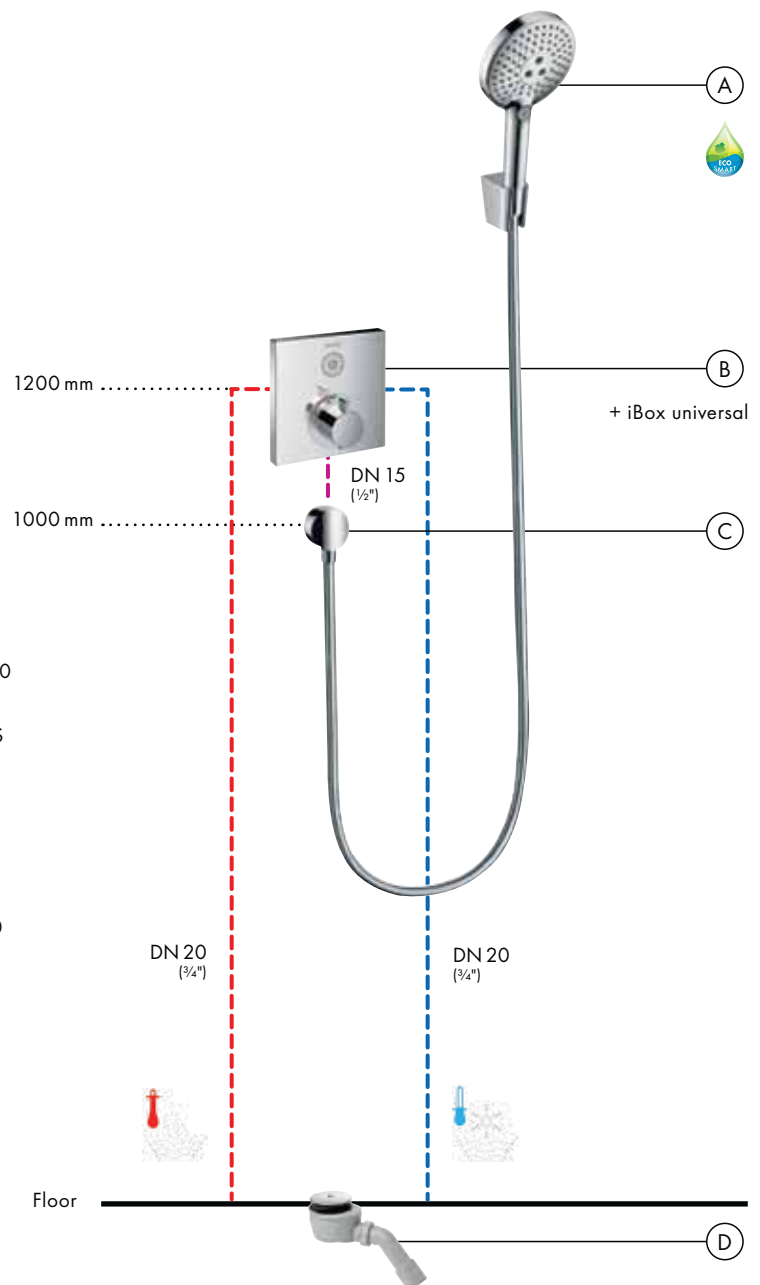

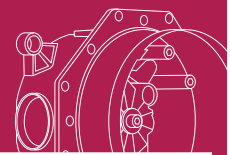

**iBox® universal**  
Installation variant  
1 and 2 functions

# Installation 2 functions

## Flow diagram

Overhead shower Raindance Select S 300 2jet  
# 27378000

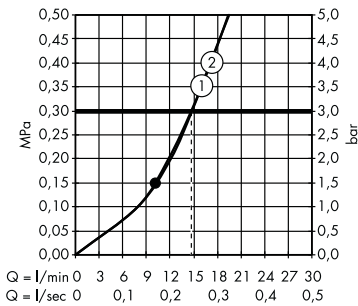

### Legend

- ① Rain
- ② RainAir

## Flow diagram

Hand shower Raindance S 120 3jet  
# 26530000

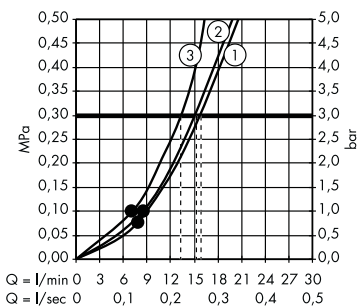

### Legend

- ① RainAir
- ② Rain
- ③ Whirl

Minimum operating pressure •

## Components

### Mixers

- Ⓑ iBox universal  
# 01800180  
ShowerSelect thermostat  
# 15763000



Alternative:  
Metris thermostat  
with shut-off/diverter valve  
# 31573000

Other alternatives possible.

### Showers

- Ⓐ Raindance Select S 300  
2jet Overhead shower  
# 27378000
- Ⓒ Raindance Select S 120  
# 26530000  
Shower holder Porter S  
# 28331000  
Shower hose Isiflex  
# 28276000
- Ⓓ Hose connection FixFit  
# 27453000
- Ⓔ Waste system Staro 90  
# 60056000

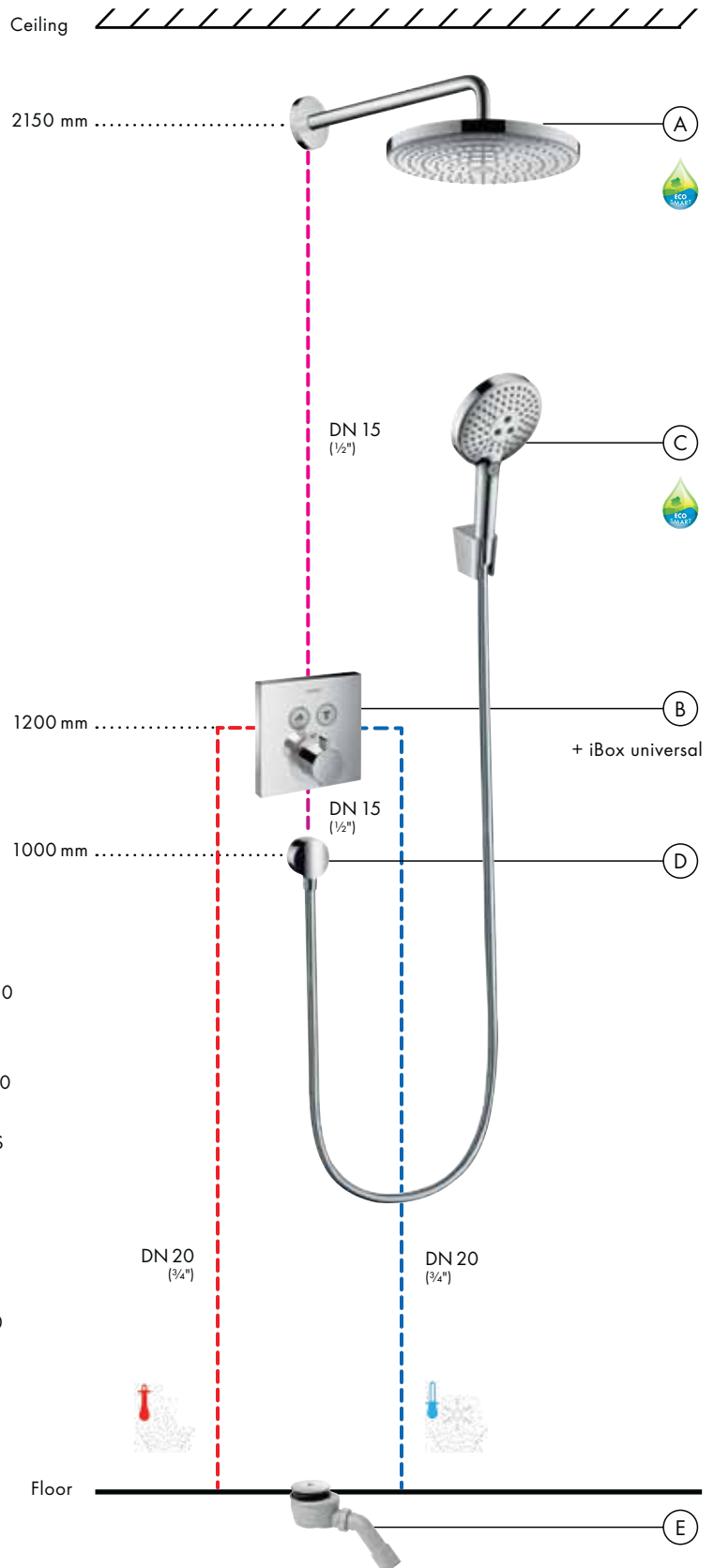

# Installation 3 functions: Select

## Flow diagram

Overhead shower Raindance Rainfall 2jet  
#28433000

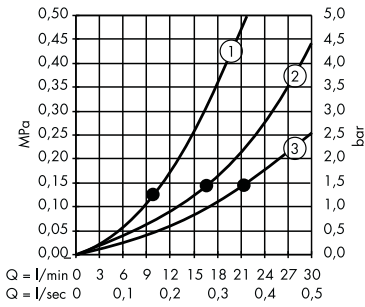

### Legend

- ① RainAir
- ② Rainflow
- ③ RainAir + Rainflow

## Flow diagram

Hand shower Raindance S 120 3jet  
#26530000

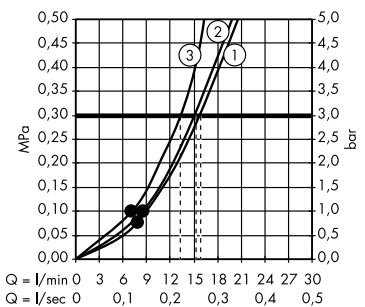

### Legend

- ① RainAir
- ② Rain
- ③ Whirl

Minimum operating pressure •

## Components

### Mixer installation

- Ⓒ iBox universal  
#01800180  
ShowerSelect valve for  
3 functions  
#15764000
- Ⓓ iBox universal  
#01800180  
ShowerSelect thermostat  
#15760000

### Shower installation

- Ⓐ Raindance Rainfall 2jet  
#28433000  
iBox universal  
#01800180
- Ⓑ Raindance Select S 120  
Hand shower  
#26530000  
Shower holder Porter S  
#28331000  
Shower hose Isiflex  
#28276000
- Ⓔ Hose connection FixFit  
#27453000
- Ⓕ Waste system Raindrain XXL  
#60067000

- Alternative:
- Metris iControl  
#31958000
- Metris Highflow thermostat  
#31571000

Other alternatives possible.

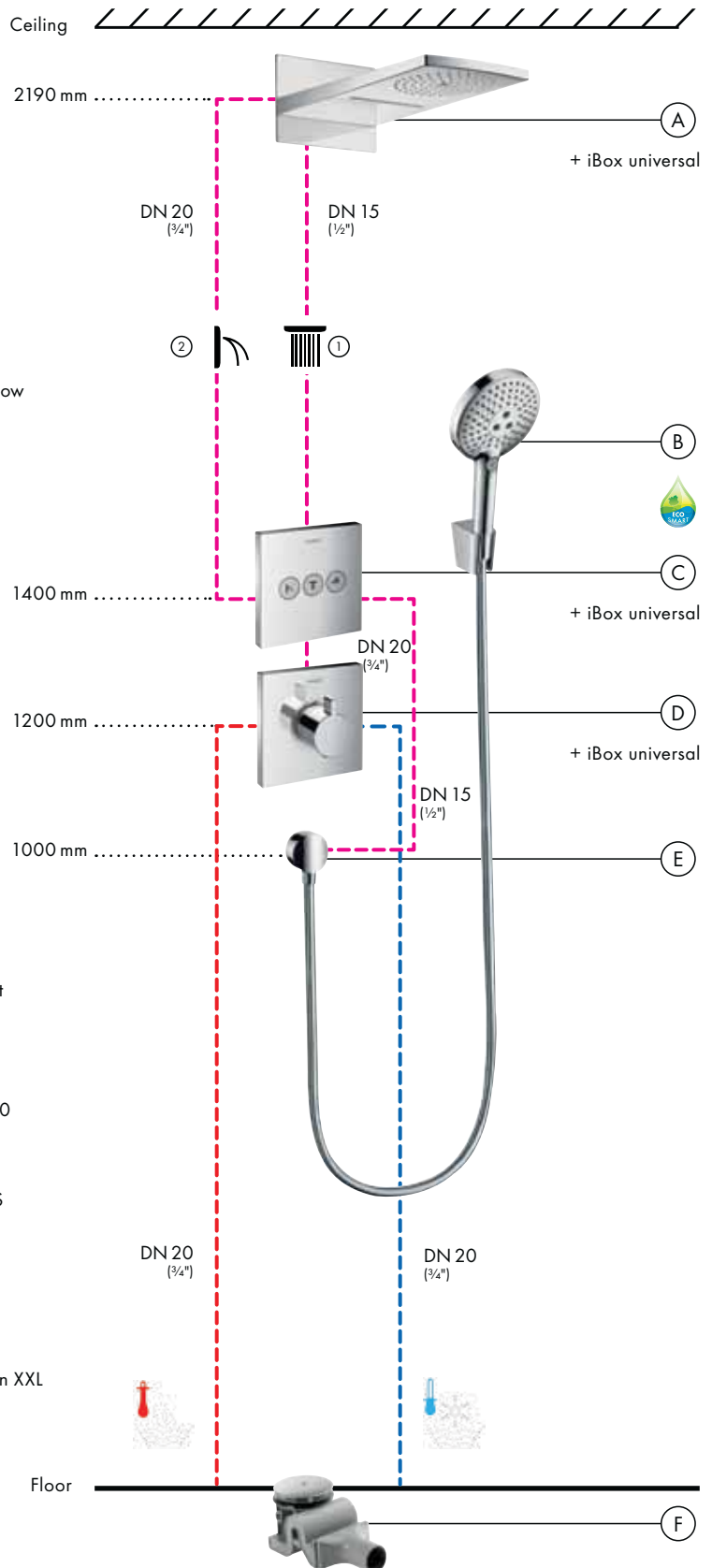

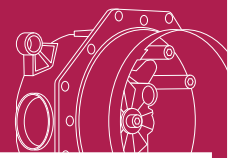

**iBox® universal**  
Installation variant  
3 functions

# Installation 3 functions: Standard

## Flow diagram

Overhead shower Raindance Rainfall 2jet  
# 28433000

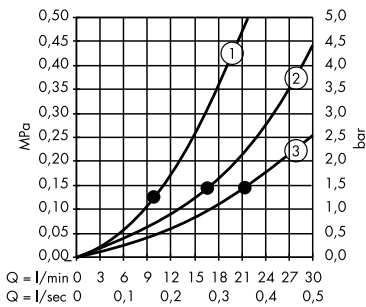

### Legend

- ① RainAir
- ② Rainflow
- ③ RainAir + Rainflow

## Flow diagram

Hand shower Raindance S 120 3jet  
# 26530000

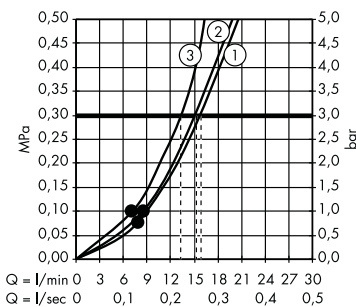

### Legend

- ① RainAir
- ② Rain
- ③ Whirl

Minimum operating pressure •

## Components

### Mixer installation

- Ⓒ Basic set Trio/Quattro  
# 15981180  
Shut-off valve Trio/Quattro S  
# 15932000
- Ⓓ iBox universal  
# 01800180  
Ecostat S Highflow thermostat  
# 15715000
- Ⓔ Basic set shut-off valve  
# 15974180  
Shut-off valve S DN15/DN20  
# 15972000

### Shower installation

- Ⓐ Raindance Rainfall 2jet  
# 28433000  
iBox universal  
# 01800180
- Ⓑ Raindance Select S 120  
3jet Hand shower  
# 26530000  
Shower holder Porter S  
# 28331000  
Shower hose Isiflex  
# 28276000
- Ⓕ Hose connection FixFit  
# 27453000
- Ⓖ Waste system Raindrain XXL  
# 60067000

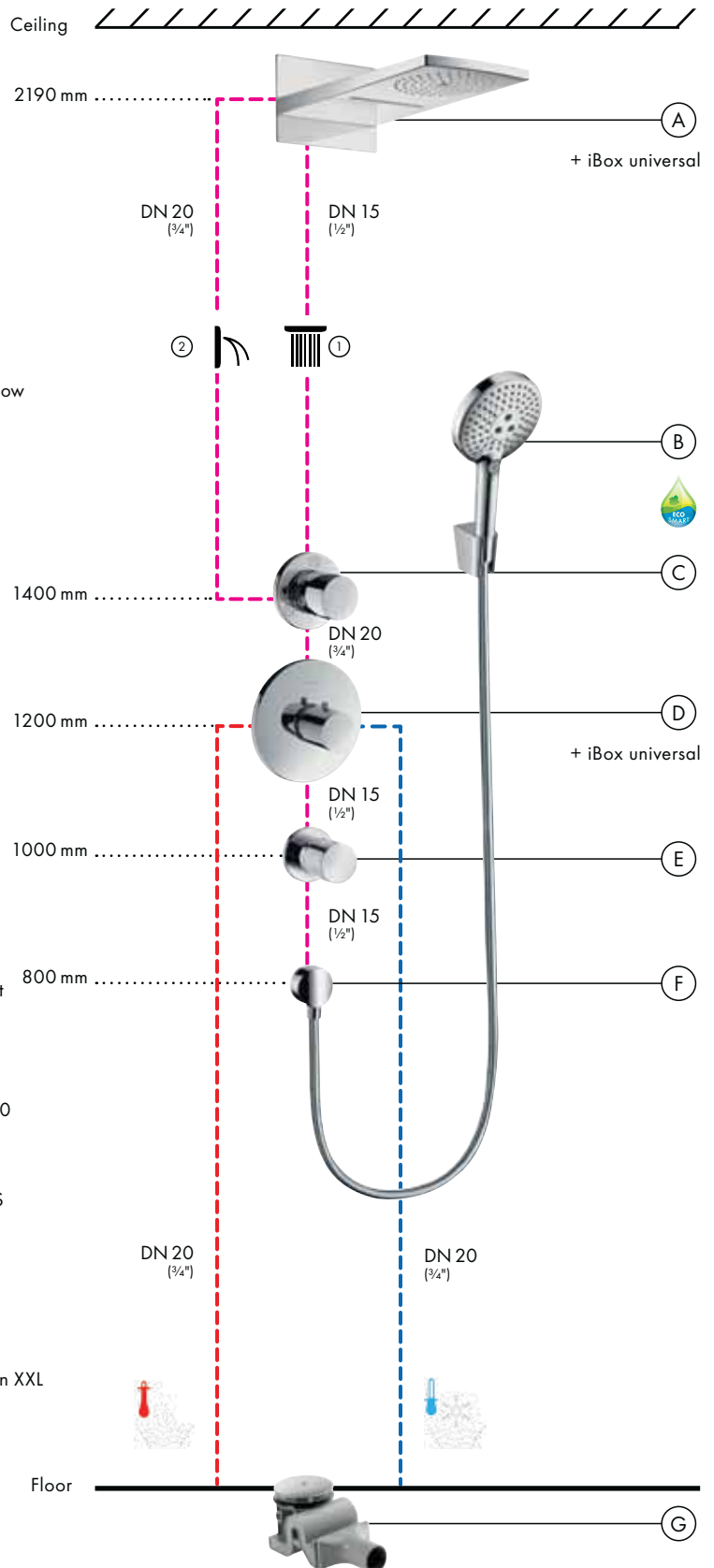

# Installation 4 functions: Select

## Flow diagram

Overhead shower Raindance Rainfall 3jet  
# 28411000

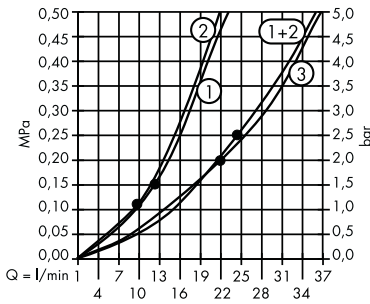

### Legend

- ① Rain
- ② Whirl
- ③ RainAir

## Flow diagram

Hand shower Raindance S 120 3jet  
# 26530000

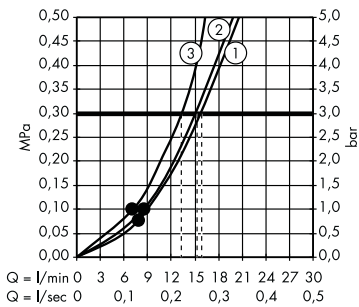

### Legend

- ① RainAir
- ② Rain
- ③ Whirl

Minimum operating pressure •

## Components

### Mixer installation

- Ⓒ iBox universal  
# 01800180  
ShowerSelect valve for  
3 functions  
# 15764000
- Ⓓ iBox universal  
# 01800180  
ShowerSelect thermostat  
# 15761000

### Shower installation

- Ⓐ Raindance Rainfall 3jet  
# 28411000  
iBox universal  
# 01800180
- Ⓑ Raindance Select S 120  
Hand shower  
# 26530000  
Shower holder Porter S  
# 28331000  
Shower hose Isiflex  
# 28276000
- Ⓔ Hose connection FixFit  
# 27453000
- Ⓕ Waste system Raindrain XXL  
# 60067000

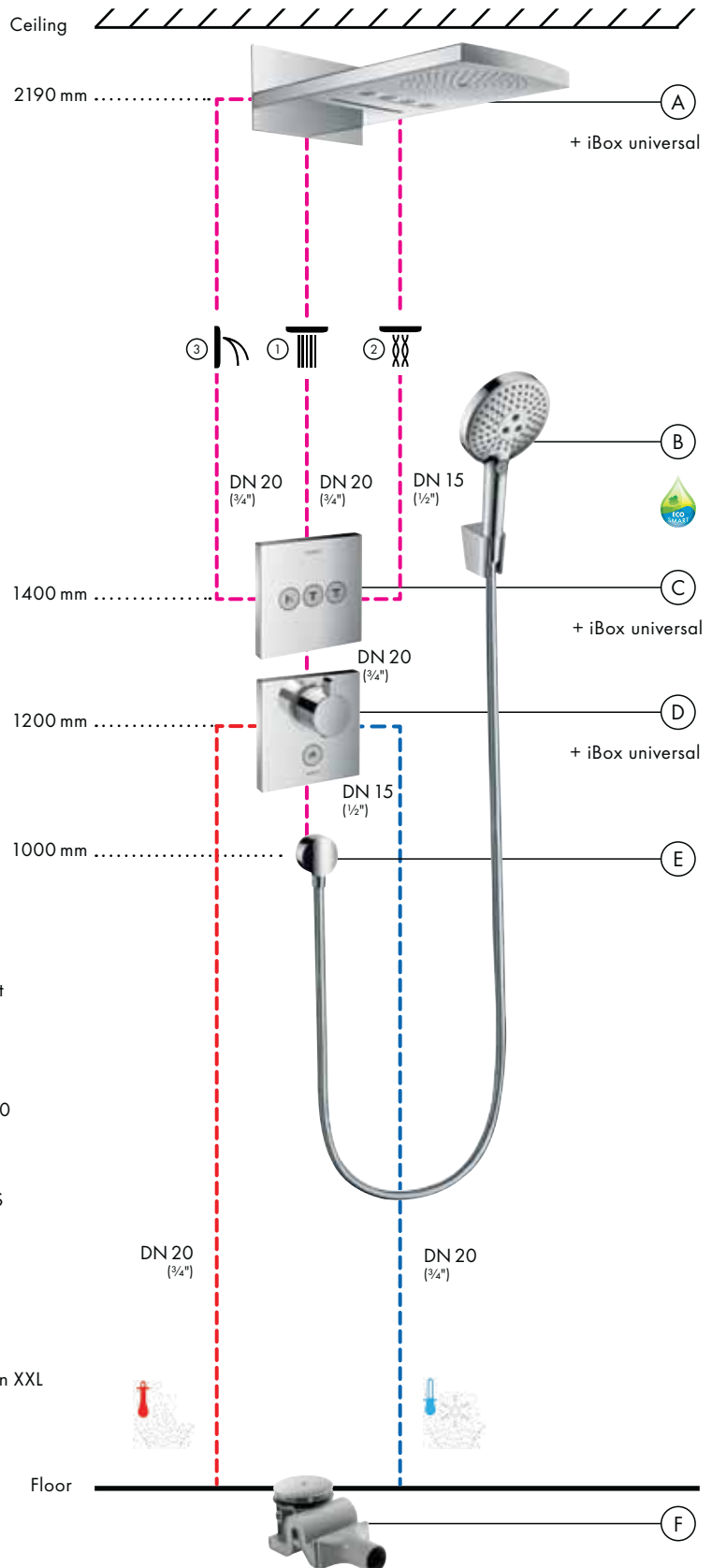

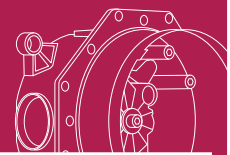

**iBox® universal**  
Installation variant  
4 functions

# Installation 4 functions: Standard

## Flow diagram

Overhead shower Raindance Rainfall 3jet  
#28411000

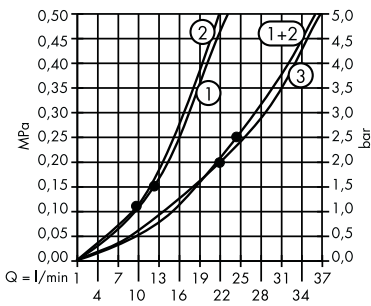

### Legend

- ① RainAir
- ② Whirl
- ③ Rainflow

## Flow diagram

Hand shower Raindance S 120 3jet  
#26530000

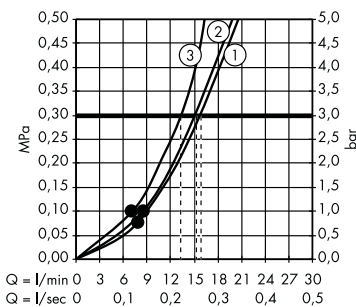

### Legend

- ① RainAir
- ② Rain
- ③ Whirl

Minimum operating pressure •

## Components

### Mixer installation

- Ⓒ Basic set Quattro  
# 15930180  
Shut-off valve Trio/Quattro S  
# 15932000
- Ⓓ Basic set shut-off valve  
# 15970180  
Shut-off valve S DN15/DN20  
# 15972000
- Ⓔ iBox universal  
# 01800180  
Ecostat S thermostat  
# 15715000
- Ⓕ Basic set shut-off valve  
# 15974180  
Shut-off valve S DN15/DN20  
# 15972000

### Shower installation

- Ⓐ Raindance Rainfall 3jet  
# 28411000  
iBox universal  
# 01800180
- Ⓑ Raindance Select S 120  
3jet Hand shower  
# 26530000  
Shower holder Porter S  
# 28331000  
Shower hose Isiflex  
# 28276000
- Ⓖ Hose connection FixFit  
# 27453000
- Ⓖ Waste system Raindrain XXL  
# 60067000

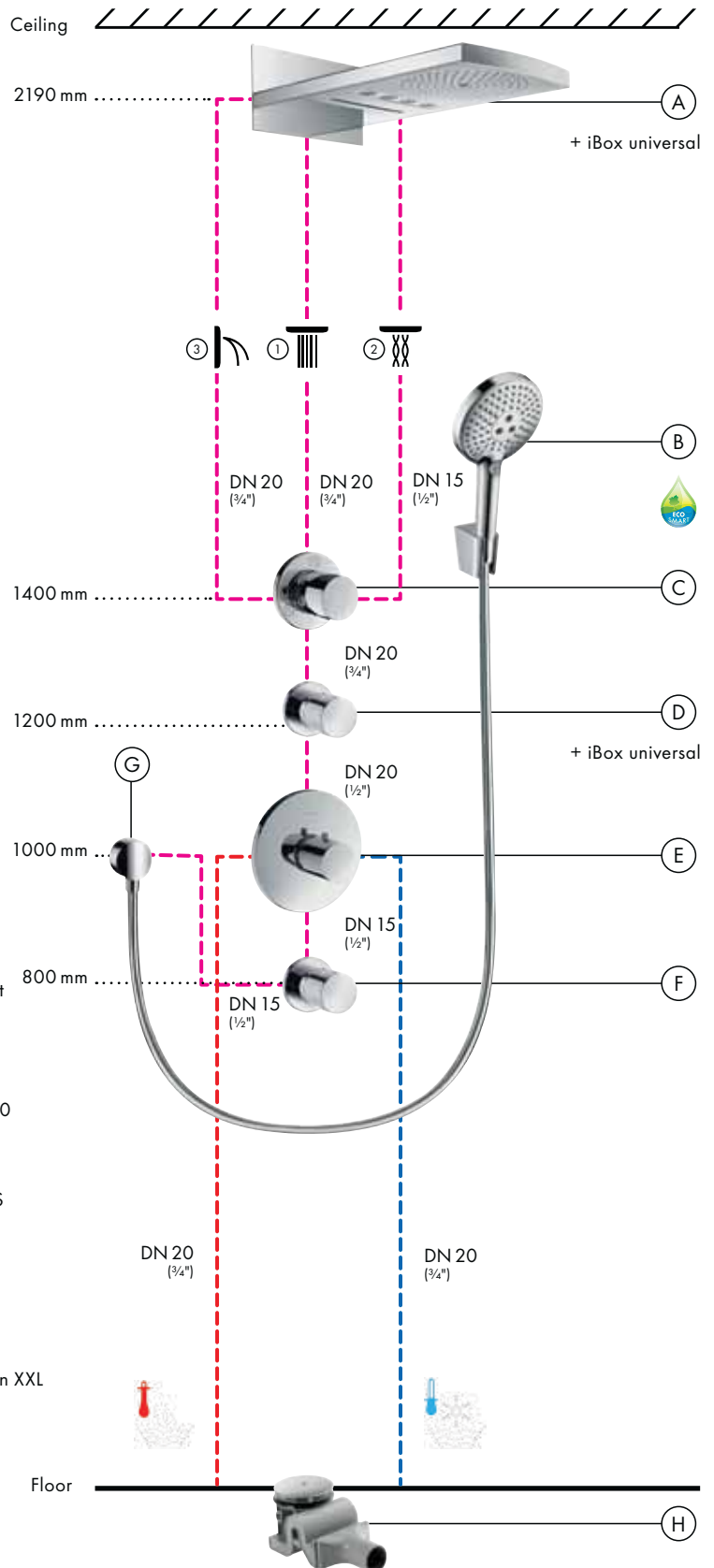

Other alternatives possible.

# iBox® universal installation

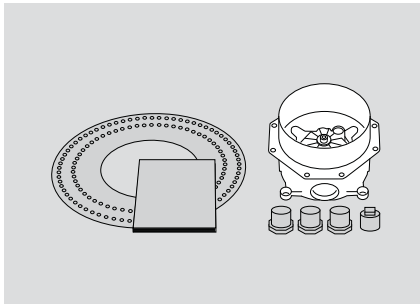

**All you need** – iBox universal plus sealing cuff, 3 reduction nipples from DN20 to DN15, 1 plug DN 20, flush block, building protection cap, 1 plug for raw installation Exafill bath fill (with waste system), installation instructions. No need to order additional accessories.

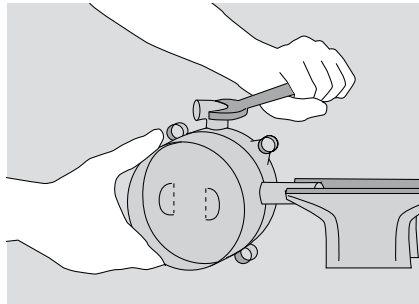

**Installation tip** – to turn in connection, secure the iBox universal in the vice using a piece of pipe with a G $\frac{3}{4}$  thread.

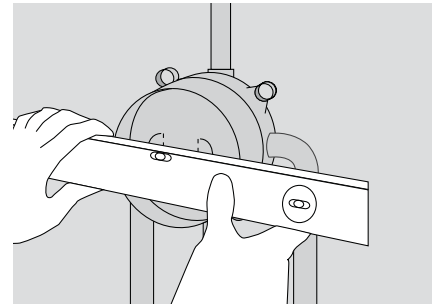

**In the right position** – it's easy to level out the iBox universal using the attached positioning tools.

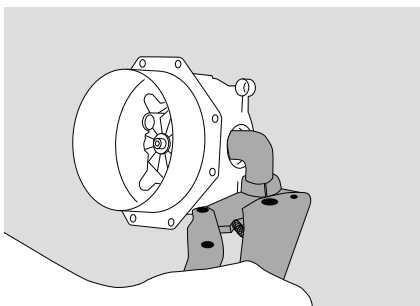

**Right connections** – designed to match any standard pipe system, the fittings can be pressed directly against the iBox universal.

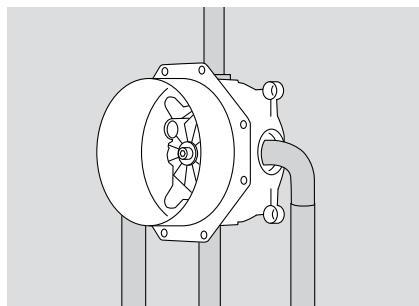

**Matching any standard installation systems** – thanks to the 2 fixing levels and the many different fixing options, the iBox universal will fit on any standard installation system.

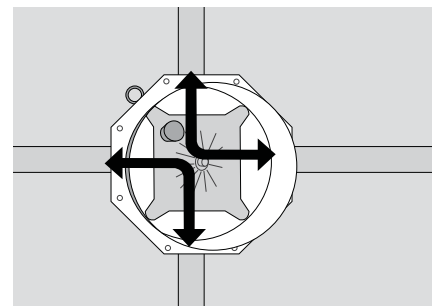

**Standard flushing to DIN 1988** – thanks to the flush block that is included, it is possible to flush the pipes in any targeted direction.

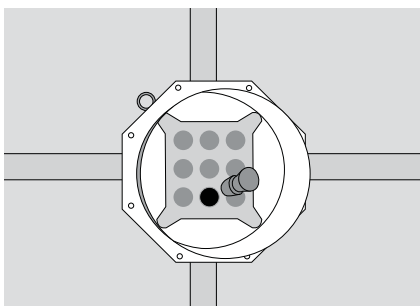

**Plug for Exafill outlet** – this plug ensures that, after testing the pipe system and filling the bath, the pressure in the whole pipe system is maintained even after the water to the intake is switched off.



**127 mm drill** – the circular shape of the iBox universal was deliberately chosen so a drill can be used. This makes it easy to make cut-outs in the wall-covering or tiles.

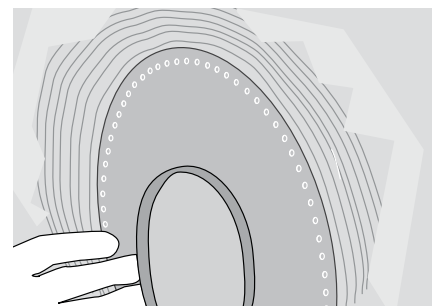

**Sealing cuff for wall front installation** – to ensure there are no leaks with wall front installation, the sealing cuff is pushed onto waterproof adhesive on the wall (or similar sealant that complies with the manufacturer's information).

# ShowerSelect® finish set installation

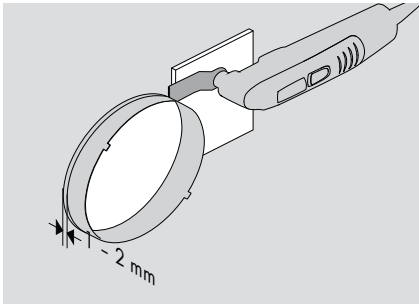

**Leave 1-2 mm free** – the protruding rim of the iBox universal is trimmed away with a sharp cutter or similar tool approx. 2 mm from the tiles. Protect the tiles. Seal with silicon.

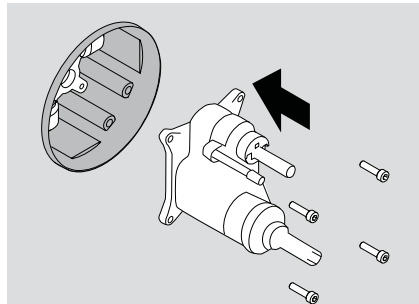

**Installation functions block** – first remove the flush block. Then insert the ShowerSelect functions block and secure using the enclosed fixing materials at a tightening torque of 5 Nm.

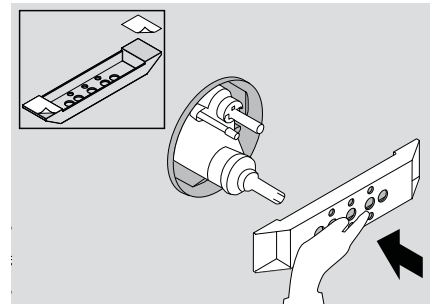

**Enclosed template** – the template with corresponding holes is used as an aid to shortening the button extension.

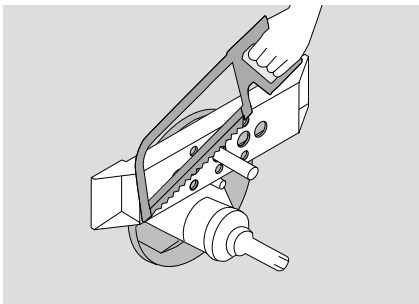

**Shorten extensions** – the button extensions are sawn flush at template height. Smooth any irregularities with sandpaper to leave a level surface.

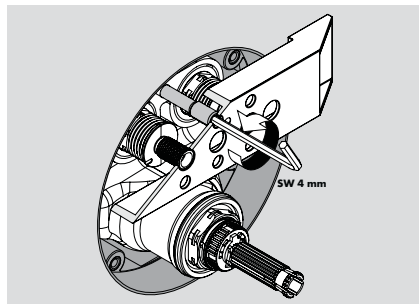

**Adjust the centring screw** – use a 4 mm Allen key (SW 4 mm) to undo the screw as far as the inner edge of the template.

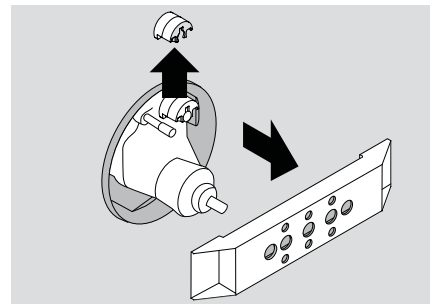

**Remove spring attachment** – remove the template and pull the spring attachment upwards.

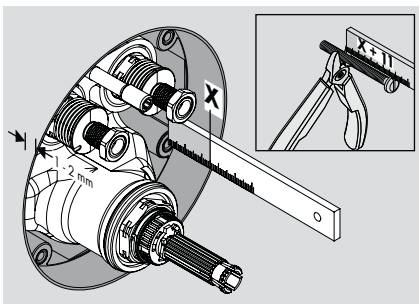

**Measure precisely** – use a folding rule or tape measure to measure the length for the fixing screws of the carrier escutcheon. Use pliers to shorten the plastic screws to the calculated length.

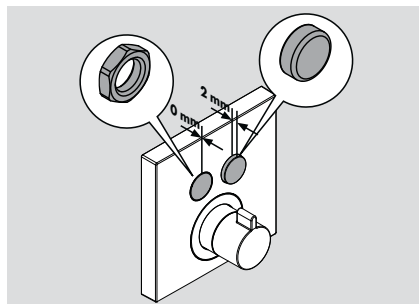

**Define key position** – Flush-fit installation (0 mm), raised (2 mm) with the extension cap using the enclosed nut.

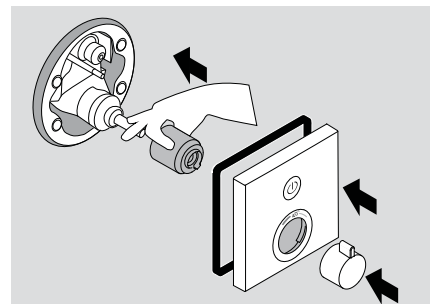

**Install finish set** – tighten the carrier escutcheon and slide the cartridge sleeve into place. Then put the foam rubber seal in the escutcheon. Attach escutcheon and seal to the carrier escutcheon together. Clip thermostat handle into place.



## Select button installation extension

---

Extension caps are used to extend the button position by 2 mm. This will make it even easier to use the control elements. Users with limited mobility can use an elbow or fist to operate.

### Without extension cap



Select button, without extension cap, closed and flush-fit



Select button, without extension cap, open, 4 mm

### With extension cap



Select button, with extension cap, closed, 2 mm



Select button, with extension cap, open, 6 mm

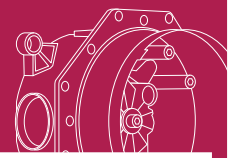

## Standard finish set installation

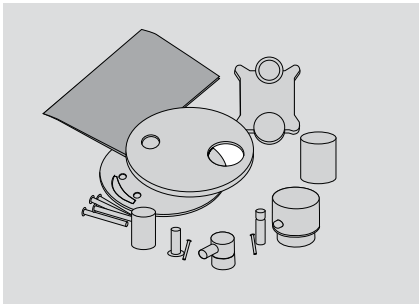

**iBox® universal** – all ready for bathing fun: functions block, fixing screws, escutcheon, handle sleeves, handle adapter, handles and installation instructions.

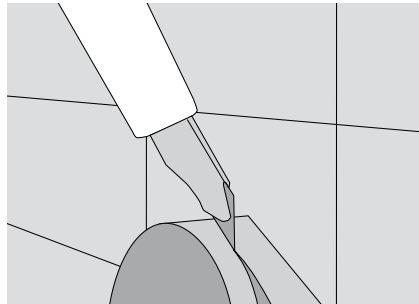

**28 mm tile leveller** – after tiling, the protruding rim of the iBox universal is trimmed with a knife to 2 mm in front of the tiles. This ensures an absolutely leakproof fit.

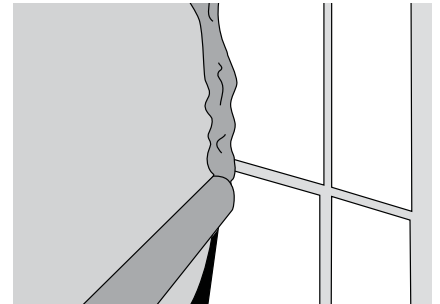

**Seal with silicon** – to ensure that the unit is sealed against splashes, silicone is injected into the seam between the iBox universal and the tiles.

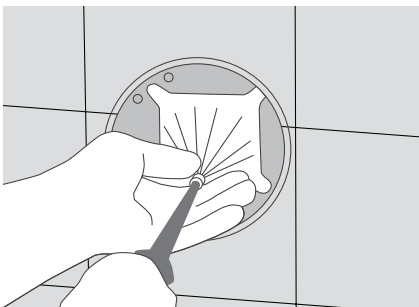

**Remove flush block**– unscrew the Allen screw and remove the flush block before installing the functions block. Don't forget to turn off the water!

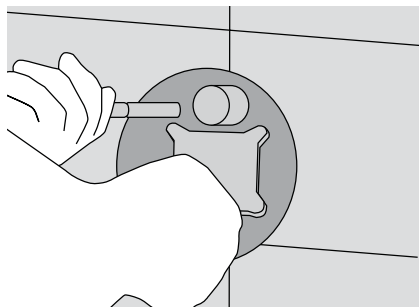

**Functions block installation** – use the enclosed fixing screws to attach the functions block directly to the connecting block.

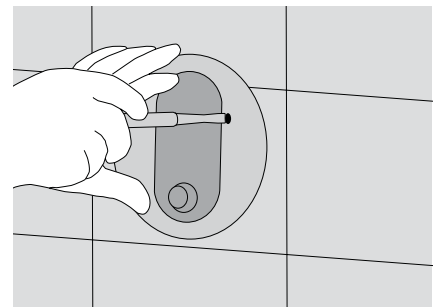

**Attach carrier escutcheon** – use easy-to-shorten plastic screws to attach the carrier escutcheon to the housing of the iBox universal\*. This provides sound-proofing to in front of the tiles. The foam rubber seal will protect against splashes in the area of the join.

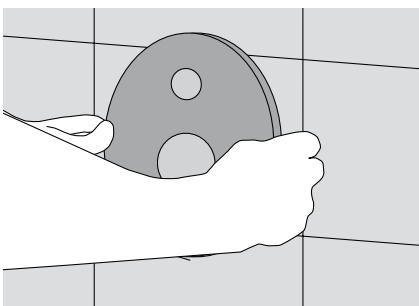

**Attach decorative rosette** – the screw-free decorative rosette simply slides over the carrier rosette. The protecting foam rubber and O-rings on the openings for the handle sleeves guarantee a safe fit.

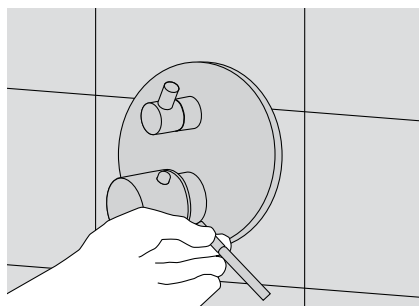

**Fixing the handles** – finally, snap the handles into place.

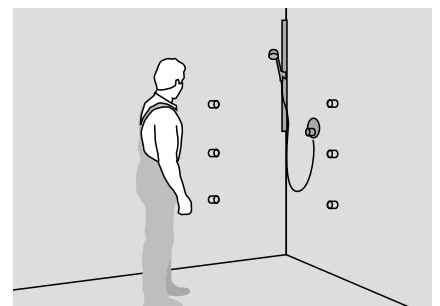

**Finish** – the iBox universal and desired finish set can be installed in a very short period of time and without having to order any accessories such as stoppers or attachment aids for the various installation methods.

\* Do not affix screws using a mechanical or powered screwdriver.

# Technical details and dimension drawings

## iBox® universal, technical information

Operating pressure:	max. 1 MPa
Recommended operating pressure:	0.1-0.5
Test pressure:	1.6
(1 MPa = 10 bar = 147 PSI)	
Hot water temperature:	max. 80 °C
Recommended hot water temperature:	65 °C
Connection dimensions:	G 3/4
Connections:	cold right, warm left
Free flow at:	0.3
Bath mixer outlet bath:	31 l/min
Bath mixer outlet shower:	24 l/min
Single lever shower mixer:	32 l/min
Thermostat:	43 l/min
Thermostat with shut-off valve:	26 l/min
Thermostat with shut-off/diverter valve:	26 l/min
Highflow thermostat:	48 l/min
Test mark:	DVGW, SVGW

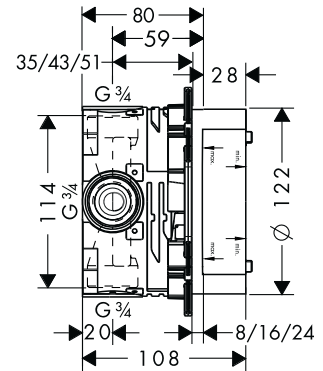
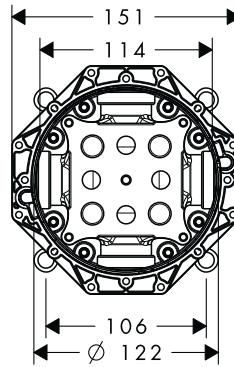

iBox® universal front and side view

## iBox® universal

Outlet 2, e.g. shower (top)

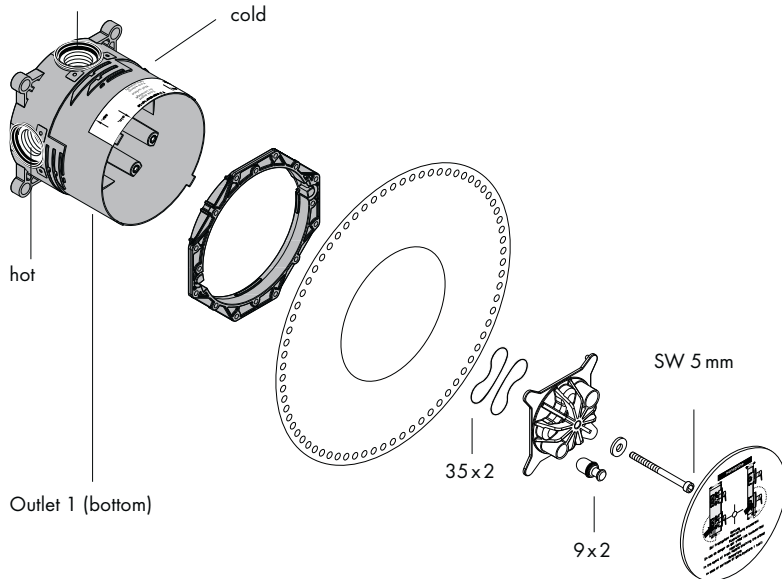

Outlet 1 (bottom)

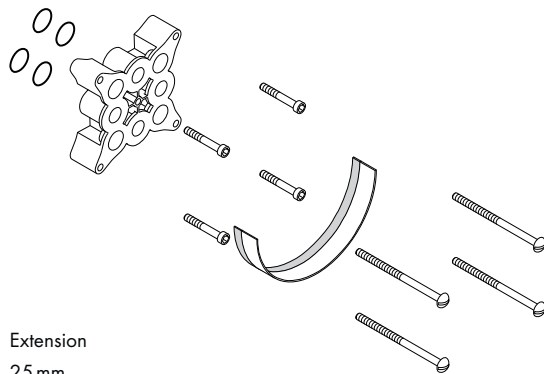

Extension  
25 mm

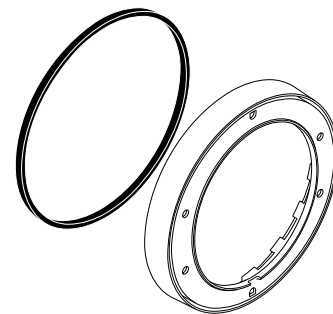

Extension 22 mm (for low installation depth)

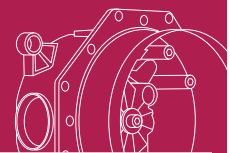

## iBox® universal

Technical data

Installation tips

# Installation tips and information

## Tips for basic installation

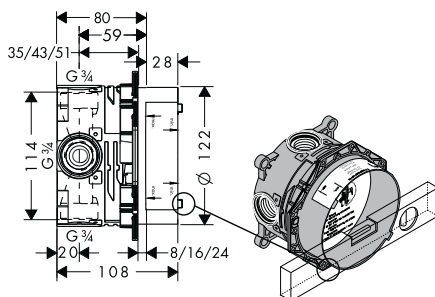
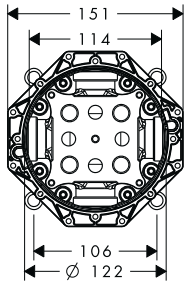

Fit the base unit with the **hot water connection on the left** and the **cold water connection on the right**.

Installation depth 80 to 108 mm.

### Extension set 25 mm for too deep installation:

# 13595000

### Extension set 22 mm for too deep installation depths:

# 13596000 for escutcheons Ø 170 mm

# 13597000 for escutcheons Ø 150 mm

# 97407000 for escutcheons Ø 172 mm

# 15597000 for PuraVida

# 13593000 for ShowerSelect

The base unit can be fitted in accordance with the structural conditions. The iBox universal is suitable for both bath and shower installation.

With single-lever bath mixers, the lower outlet (outlet 1) has priority. With shower installations, the outlet that is not required needs to be stopped with a plug.

The symmetrical-rotation base unit of the iBox universal can be used horizontally or vertically.

**Exception:** installation of bath mixers with safety combinations, where only vertical installation is possible.

## Sinks

Complete installation as per DIN 1988/EN 1717, part 2 sinks. The arrows on the flush block indicate which inlet is connected to which outlet line, e.g. cold water with outlet 1 and hot water with outlet 2. If only one outlet is required, then the flush block needs to be rotated by 90° after the first flush.

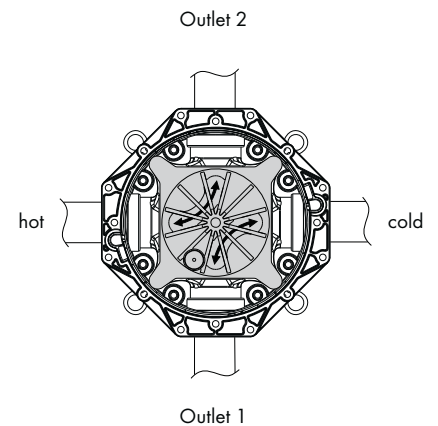

## Tips for the bath

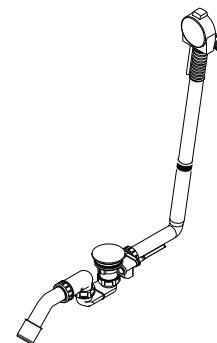
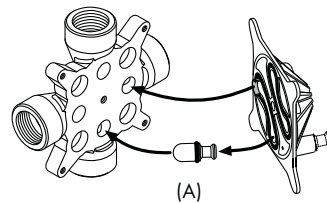

### iBox® universal in combination with Exafill bath filler with waste system:

switch off water to the Exafill during the construction stage!

#### Basic installation:

1. Install iBox universal
2. Lay pipes to Exafill and block (metal plug)
3. Flush and press pipe system

#### Place bath:





1. Switch off water
2. Install bath with Exafill and connect to mains water
3. Flush pipe to Exafill with sample filler necks and check for leaks
4. Switch off water at floor level
5. Remove flush block
6. Insert plug (A) in outlet for Exafill
7. Fit flush block
8. Switch on water





Go to [www.hansgrohe.co.uk](http://www.hansgrohe.co.uk) for the installation instructions.





# Product overview Hansgrohe® finish sets

## Thermostat/mixer finish sets

ShowerSelect®	ShowerSelect®	ShowerSelect®	ShowerSelect®	ShowerSelect®	ShowerSelect®	
						
Highflow Thermostat # 15760, -000	Highflow thermostat for 1 function (bottom) and one additional function (top) # 15761, -000	Valve for 3 functions # 15764, -000	Thermostat for 1 function # 15762, -000	Thermostat for 2 functions # 15763, -000	Thermostat for 2 functions with FixFit and Porter # 15765, -000	

PuraVida®	PuraVida®	PuraVida®	PuraVida®	PuraVida®
				
Thermostat # 15770, -000, -400	Thermostat with shut-off valve # 15775, -000, -400	Shut-off/diverter valve # 15777, -000, -400	Bath # 15445, -000, -400 # 15447, -000, -400	Shower # 15665, -000, -400
Highflow thermostat # 15772, -000, -400 Not shown	Thermostat with shut-off/diverter valve # 15771, -000, -400 Not shown			

Metris®	Metris®	Metris®	Metris®	Metris®
				
Thermostat # 31570, -000	Thermostat with shut-off valve # 31572, -000	Shut-off/diverter valve # 31958, -000	Bath # 31493, -000 # 31487, -000*	Shower # 31685, -000
Highflow thermostat # 31571, -000 Not shown	Thermostat with shut-off/diverter valve # 31573, -000 Not shown			

Metris® S	Metris® S	Metris® Classic	Metris® Classic	Metris® Classic
				
Bath # 31465, -000 # 31466, -000*	Shower # 31665, -000	Bath # 31485, -000 # 31486, -000*	Shower # 31676, -000	Thermostat with shut-off/diverter valve # 15753, -000

Please refer to the Hansgrohe price list or catalogue for details of the various finishes.

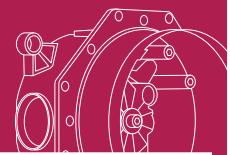

**Talis® E²**



Bath  
# 31645,-000  
# 31646,-000\*

**Talis® E²**



Shower  
# 31666,-000

**Talis®/Talis® S**



Bath  
# 32475,-000  
# 32477,-000

**Talis®/Talis® S**



Shower  
# 32675,-000

**Talis® Classic**



Bath  
# 14145,-000  
# 14146,-000\*

**Talis® Classic**



Shower  
# 14165,-000

**Focus®**



Bath  
# 31945,-000  
# 31946,-000\*

**Focus®**



Shower  
# 31965,-000

**Focus® E**



Bath  
# 31744,-000

**Focus® E**



Shower  
# 31761,-000

**Focus® S**



Bath  
# 31743,-000

**Focus® S**



Shower  
# 31763,-000

**Ecostat® S**



Thermostat  
# 15711,-000

Highflow thermostat  
# 15715,-000  
Not shown

**Ecostat® S**



Thermostat  
with shut-off valve  
# 15701,-000

Thermostat  
with shut-off/diverter  
valve  
# 15721,-000  
Not shown

**iControl® S**



Shut-off/diverter valve  
# 15955,-000

**Overhead showers/Showerpipe – with iBox® universal basic set**

**Raindance® Rainfall® 240 Air 3jet**



Without light # 28411,-000,-400  
With light # 28410,-000,-400

**Raindance® Rainfall® 180 Air 2jet**



# 28433,-000,-400

**Raindance® Select E 300 3jet**



Overhead shower  
# 26468,-000, 400

**Raindance® E 420 Air 2jet**



Overhead shower  
# 27372,-000

**Raindance® 240**























Showerpipe  
# 27145,-000

\* with integrated safety combination according to EN 1717, part 2.

# Product overview Axor® finish sets

## Thermostat/mixer finish sets

Axor® Massaud	Axor® Massaud	Axor® Massaud	Axor® Massaud	Axor® Starck Organic	Axor® Starck Organic	Axor® Starck Organic	Axor® Starck Organic
							
Thermostat # 18740,-000	Thermostat with shut-off valve # 18745,-000	Bath # 18455,-000 # 18457,-000*	Shower # 18655,-000	Thermostat # 12710,-000	Thermostat with shut-off valve # 12715,-000	Bath # 12415,-000 # 12416,-000*	Shower # 12605,-000
Highflow thermostat # 18741,-000 Not shown	Thermostat with shut-off/diverter valve # 18750,-000 Not shown			Highflow thermostat # 12711,-000 Not shown	Thermostat with shut-off/diverter valve # 12716,-000 Not shown		
Axor® Starck	Axor® Starck	Axor® Starck	Axor® Starck	Axor® Starck X	Axor® Starck X	Axor® Starck X	Axor® Starck X
							
Thermostat # 10710,-000	Thermostat with shut-off valve # 10700,-000	Bath # 10416,-000 # 10418,-000	Shower # 10616,-000	Thermostat # 10716,-000	Thermostat with shut-off valve # 10706,-000	Bath # 10445,-000 # 10447,-000*	Shower # 10645,-000
Highflow thermostat # 10715,-000 Not shown	Thermostat with shut-off/diverter valve # 10720,-000 Not shown			Highflow thermostat # 10717,-000 Not shown	Thermostat with shut-off/diverter valve # 10726,-000 Not shown		
Axor® Urquiola	Axor® Urquiola	Axor® Urquiola	Axor® Urquiola	Axor® Urquiola			
							
Thermostat # 11730,-000	Thermostat with shut-off valve # 11732,-000	Bath # 11425,-000 # 11426,-000*	Combined bath filler/Porter Unit # 11435,-000	Shower # 11625,-000			
Highflow thermostat # 11731,-000 Not shown	Thermostat with shut-off/diverter valve # 11733,-000 Not shown						





















Please refer to the Hansgrohe price list or catalogue for details of the various finishes.



**iBox® universal**

Select your

Shower Pleasure

<b>Axor® Bouroullec</b>	<b>Axor® Bouroullec</b>	<b>Axor® Bouroullec</b>	<b>Axor® Bouroullec</b>	<b>Axor® Uno²</b>	<b>Axor® Uno²</b>	<b>Axor® Uno²</b>	<b>Axor® Uno²</b>
							
Thermostat # 19700,-000	Thermostat with shut-off valve # 19704,-000	Bath # 19421,-000 # 19422,-000*	Shower # 19621,-000	Thermostat # 38375,-000	Thermostat with shut-off valve # 38700,-000	Bath # 38425,-000 # 38427,-000*	Shower # 38625,-000
Highflow thermostat # 19702,-000 Not shown	Thermostat with shut-off/diverter valve # 19706,-000 Not shown			Highflow thermostat # 38715,-000 Not shown	Thermostat with shut-off/diverter valve # 38720,-000 Not shown		
<b>Axor® Citterio</b>	<b>Axor® Citterio</b>	<b>Axor® Citterio</b>	<b>Axor® Citterio</b>	<b>Axor® Citterio M</b>	<b>Axor® Citterio M</b>	<b>Axor® Citterio M</b>	<b>Axor® Citterio M</b>
							
Thermostat # 39715,-000 # 39710,-000**	Thermostat with shut-off valve # 39705,-000 # 39700,-000*	Bath # 39455,-000 # 39457,-000	Shower # 39655,-000	Thermostat # 34715,-000	Thermostat with shut-off valve # 34705,-000	Bath # 34425,-000 # 34427,-000*	Shower # 34625,-000
Highflow thermostat # 39716,-000 # 39711,-000* Not shown	Thermostat with shut-off/diverter valve # 39725,-000 # 39720,-000** Not shown			Highflow thermostat # 34716,-000 Not shown	Thermostat with shut-off/diverter valve # 39725,-000 Not shown		
<b>Axor® Carlton</b>	<b>Axor® Carlton</b>	<b>Axor® Montreux</b>	<b>Axor® Montreux</b>				
							
Thermostat # 17710,-000 # 17715,-000***	Thermostat with shut-off valve # 17700,-000,-090 # 17705,-000,-090	Thermostat # 16810,-000,-820	Thermostat with shut-off valve # 16800,-000,-820				
Highflow thermostat # 17712,-000,-090 # 17716,-000,-090 Not shown	Thermostat with shut-off/diverter valve # 17720,-000,-090 # 17725,-000,-090 Not shown	Highflow thermostat # 16815,-000,-820 Not shown	Thermostat with shut-off/diverter valve # 16820,-000,-820 Not shown				

\* with integrated safety combination according to EN 1717, part 2.

\*\* with lever handle.

\*\*\* with cross handle.





The Hansgrohe iBox universal is multi talented: it creates more space, freedom of movement and planning freedom in the bathroom – and is really quick and easy to install. Go to **[www.pro.hansgrohe.co.uk/ibox](http://www.pro.hansgrohe.co.uk/ibox)** to find out more about the iBox universal and its benefits



We did our utmost to ensure that the printing of this brochure was friendly to the environment. You too can contribute to the protection of our environment by passing on the brochure to others when you've finished reading it, or by recycling it.



## PartnerPlus services:

### Hansgrohe Customer Service

For technical enquiries, experts in the sanitary trade will be happy to assist you with their extensive knowledge of the entire Hansgrohe product range. Service and replacement parts are delivered in the fastest possible manner.

Service hours:  
Monday – Friday: 9 am – 5 pm  
Phone: 01372 472001  
Fax: 01372 470670  
E-Mail: [technical@hansgrohe.co.uk](mailto:technical@hansgrohe.co.uk)

### Hansgrohe Sales Service

Phone enquiries regarding products and delivery times.

Service hours:  
Monday – Friday: 9 am – 5 pm  
Phone: 01372 472001  
Fax: 01372 470670  
E-Mail: [orders@hansgrohe.co.uk](mailto:orders@hansgrohe.co.uk)

### Hansgrohe replacement part guarantee

We guarantee the availability of replacement parts for up to ten years. This gives you peace of mind, even for projects that were completed some time ago.

### Hansgrohe guarantee of quality

Superior quality is a vital part of the Hansgrohe business philosophy. For this reason, we voluntarily offer consumers a manufacturer's guarantee on our products for a period of five years. Details at [www.hansgrohe-int.com/](http://www.hansgrohe-int.com/) guarantee.

### The Hansgrohe Aquademie, Esher, Surrey

Our Aquademie has the greatest range of Hansgrohe products anywhere in the UK, some displayed in room settings that will inspire you. Based in Esher, Surrey we have over three hundred squared metres of floor space.

Working displays enable you to see the many benefits of the products for yourself.

By appointment only.  
Opening Hours:  
Monday – Friday: 9 am – 4.30 pm  
Phone: 01372 465 655

### The Hansgrohe Aquademie, Schiltach, Germany

The Aquademie is our event centre where you can experience everything to do with water. Visit our museum to learn all about the history of bathing and the bathroom. Discover in our exhibition how international design stars turn a bathroom into a true oasis of well-being. Let us show you how innovative technologies can make saving water a pure pleasure. Or experience great shower and water fun in our Showerworld, Germany's largest bathroom.

Opening hours:  
Monday – Friday: 7.30 am – 7 pm  
Saturday – Sunday: 10.30 am – 4 pm  
Free admission. Booking required.  
Please bring swimwear.

en-UK Technical information iBox® universal · Subject to technical changes and colour variations for technical reasons.  
Form-Nr. 84090373 · 06/13/10,3 · Printed in Germany · Printed on 100 % chlorine-free bleached paper.

Hansgrohe · Units D1 and D2 · Sandown Park Trading Estate · Royal Mills  
Esher · Surrey · KT10 8BL · Tel. +44 1372 472001 · Fax +44 1372 470670  
[enquiries@hansgrohe.co.uk](mailto:enquiries@hansgrohe.co.uk) · [www.hansgrohe.co.uk](http://www.hansgrohe.co.uk) · [www.pro.hansgrohe.co.uk](http://www.pro.hansgrohe.co.uk)

