

GROHE KITCHEN

*Pure Freude
an Wasser*

GROHE
WAVES

YOUR
KITCHEN

**THE
SOURCE
OF
LIVING**



GROHE | MASTERS OF TECHNOLOGY



UNIDOMO®

Web: www.unidomo.de

Telefon: 04621- 30 60 89 0

Mail: info@unidomo.com

Öffnungszeiten: Mo.-Fr. 8:00-17:00 Uhr

VIESSMANN

Buderus

 **Vaillant**

WOLF

 **JUNKERS**  **BOSCH**

 **remeha**

 **DAIKIN**

ROTEX

a member of DAIKIN group



-  Individuelle Beratung
-  Kostenloser Versand
-  Hochwertige Produkte

-  Komplettpakete
-  Über 15 Jahre Erfahrung
-  Markenhersteller



Link to Good Living

ABOUT LIXIL

LIXIL is the most comprehensive and connected global company in the housing and building industry, delivering human-centric innovation that enhances people's living spaces – we call this Living Technology.

Delivering core strengths in water, housing, building and kitchen technologies, our brand portfolio businesses including LIXIL, GROHE, American Standard Brands and Permasteelisa are leaders in the industries and regions in which they operate, bringing better living solutions to the world today and for future generations.

THE SOURCE OF LIVING

Water is used for drinking and cooking all over the world. We use running water in the kitchen around 100 times every day! We take it so much for granted that we often don't think of water when we hear the word kitchen. We forget what has to work hardest in the kitchen: the kitchen tap. An appliance that is used this frequently must naturally be durable and function perfectly every day. In addition, since kitchens are increasingly becoming living spaces, it also has to look great. That is why ergonomics, functionality, aesthetics and finishes are so important in GROHE kitchen taps. In short this is why we refer to GROHE in the kitchen as [The Source of Living.](#)





THE SOURCE OF ENJOYMENT

GROHE delivers top-quality drinking water directly from the tap – from refreshingly cold to boiling hot. For filtered, chilled and carbonated water, choose GROHE Blue® Chilled & Sparkling. If you like it hot, install our GROHE Red® boiling water taps. They look great, offer amazing convenience, and GROHE Blue® cuts out the need to buy bottled water, making a valuable contribution to the environment. GROHE helps you enjoy water any way you want.

THE SOURCE OF TECHNOLOGY

High-quality materials, outstanding design and innovative technologies ensure that your GROHE faucet will last a lifetime. Our tap levers feature GROHE SilkMove® technology, making them extremely easy and precise to operate. Many different designs and spout heights give you huge scope when choosing your kitchen furniture and sink; whilst pre-window models, integrated dishwasher shut-off valves and low-pressure variants ensure there is a model to meet all your installation requirements.

THE SOURCE OF STYLE

Our full range of modern 'cosmopolitan', timeless 'contemporary', and simply 'authentic' style taps offers you exactly the right tap to match your needs and your taste. You will want your kitchen tap to stay looking as good as the day it was installed. GROHE StarLight® chrome resists scratches and ensures a lifelong shiny finish, and if you like the look of stainless steel, you'll love our SuperSteel finish.

THE SOURCE OF CONVENIENCE

Many of our models are available with pull-out mousseurs and sprays, a convenient and time-saving feature, either for rinsing salads, vegetables or for washing greasy pans. You will be amazed at the adaptability and flexibility of our range of professional sprays – to help make your life in the kitchen as easy as possible.





JULIA NEUMANN

Master of Technology, measures the water temperature of GROHE Red[®], which delivers up to 100 °C hot water in an instant. The GROHE CoolTouch[®] technology ensures the spout is never too hot to touch despite the very high temperature of the water.



MASTERS OF TECHNOLOGY

GROHE's people have been regarded by their peers in the industry as Masters of Technology, because of their innovations, outstanding design and award-winning fittings.

By a combination of their advanced craftsmanship and their cutting-edge approach to effective teamwork and processes, our Masters of Technology take the lead in developing, designing and manufacturing our outstanding product range, all the while testing and fine-tuning each piece to ensure continued customer satisfaction.

The result: Timeless design. And quality that lasts a lifetime. Again and again GROHE products surprise users with unique features that provide 'Pure Freude an Wasser'. When you use a GROHE product you can feel the difference. Time after time.

Take, for example, GROHE Red® that delivers instantly 99°C hot water and the spout remains cool – and safe – at all times with GROHE Cooltouch® technology. Another kitchen highlight is the GROHE Blue® water system for freshly filtered and chilled table water straight from the tap and with different degrees of carbonation. Say goodbye to the hassle and inconvenience of bottled water, while the excellent taste of GROHE Blue® water promotes health and increases performance. GROHE kitchen taps feature exciting functions according to your daily needs and the design of the tap fits perfectly into your kitchen. Water is the source of living, fresh free-flowing and essential – sourced from our GROHE kitchen taps, it brings joy and pleasure to the everyday.

HANDS ON FEATURES

Accommodating your every wish and desire, GROHE water systems and kitchen taps include user-centric features and ingenious details that make all the difference. More choice, more comfort and more flexibility; which is why our products are such a pleasure to use.



Lead+Nickel Free

No contact of water with lead and nickel due to isolated inner water ways.



EasyExchange

The aerator is easy to install and de-install using just a coin.



RealSteel

Made of solid stainless steel, a robust material with anti-bacterial properties.



EasyTouch

Just touch the tap at any point with your wrist, elbow or just your fingertip to turn the faucet ON and OFF.



FootControl

Just touch the bottom side of the cabinet with a gentle tap of your foot to turn the tap ON and OFF.



ProfessionalSpray

Features a 360° spring arm and easy switching between the spray and mousseur.



Pull-Out Dual Spray

Increases operating radius of the tap and offers easy switching between mousseur and the spray.



Pull-Out Mousseur Spray

Increases operating radius of the tap and offers different sprays.



Pull-Out Mousseur

Increases the operating radius of your tap.



EasyDock
Guaranteed easy retraction and smooth docking for your pull-out spray head, every time.



SpeedClean
Remove limescale with a single wipe.



PreWindow
To open the window, just lift up the tap and lay it flat on the surface.



ComfortHeight
Height of the spout allows easy filling of large pots.



SwivelStop
Limited turn angle prevents flooding.



Forward Rotating Lever
Forward rotating lever prevents the lever hitting the backsplash.



Enhanced Water
Superior-quality water directly from the kitchen tap – saving time, money and the environment.



ChildLock
Integrated safety mechanism prevents unintentional opening by young children.



Titanium Inside
All boilers in our GROHE Red® collection are made from titanium.

YOUR GROHE KITCHEN LINES AT A GLANCE

GROHE WATER SYSTEMS

Make water a source of enjoyment with our water systems, delivering filtered, chilled, sparkling or boiling water direct from your tap.

GROHE
BLUE®



16

GROHE
RED®



34

GROHE PREMIUM LIFESTYLE COLLECTIONS

Introduce a source of individuality to your kitchen. Passionate home chefs will love these cutting-edge designs, combining innovative features with professional-level performance.

GROHE
K7



54

GROHE
ZEDRA
TOUCH



62

GROHE
MINTA
TOUCH



64

GROHE
K7
FOOTCONTROL



68

GROHE
ESSENCE
FOOTCONTROL



70

GROHE
ZEDRA



72

GROHE
MINTA

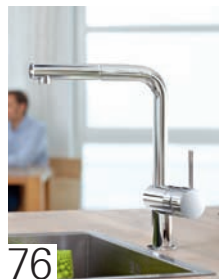

76

GROHE
K4



84

GROHE
ESSENCE



86

GROHE
EUROCUBE



92

GROHE
AMBI



96

GROHE
PARKFIELD



98

GROHE PERFORMANCE LINES

The source of functionality in your kitchen. Our performance lines offer practical features, installation options and unrivalled design choices, perfect for every home.

GROHE
EUROPLUS



104

GROHE
EURODISC
COSMOPOLITAN



106

GROHE
EURODISC



110

GROHE
CONCETTO



112

GROHE
EUROSTYLE
COSMOPOLITAN



116

GROHE
EUROSMART
COSMOPOLITAN



120

GROHE
EUROSMART



124

GROHE
BAU



130

GROHE
COSTA S



132



REST EASY WITH OUR 5 YEAR GUARANTEE.

You can always rely on the performance and quality of our innovative water systems. That is why we provide a full 5 year guarantee – far in excess of the 2 year legal minimum. For more details on our guarantee, please see the service area at grohe.co.uk or speak with your GROHE representative.

GROHE WATER SYSTEMS

THE SOURCE OF ENJOYMENT

Water is the source of life, fresh, free-flowing and essential. Our range of water systems offers a tailored drinking experience of purity and convenience that will turn water into a source of health and enjoyment in your home.

Kettle-hot or filtered, chilled still or sparkling, our water systems deliver ready-to-use water conveniently from your kitchen tap .

GROHE
BLUE®



16

GROHE
RED®



34





GROHE BLUE®

Imagine drinking water fresh from a mountain spring – life-affirming, thirst-quenching, and absolutely pure. Now imagine the same health-giving, untainted water flowing directly from your own kitchen tap. The GROHE Blue® water system makes this a reality in your own home. It transforms ordinary tap water and filters it, leaving a taste as fresh and pure as nature intended.

Whatever your idea of perfect water refreshment – filtered, chilled, sparkling or all three – GROHE Blue® brings it to you straight from the tap.

FIND OUT THE WAYS IN WHICH GROHE BLUE® BRINGS BENEFITS TO YOUR HOME:

TASTE

GROHE's filters remove impurities to give water a pure, fresh taste that even beats bottled water

HEALTH & WELLNESS

removing even small particles but leaving behind precious minerals, GROHE Blue® makes it easy to embrace the health-giving properties of water

CONVENIENCE

no more carrying heavy bottled water home

SUSTAINABILITY

kinder to the environment, with less waste on packaging and processing compared to bottled water

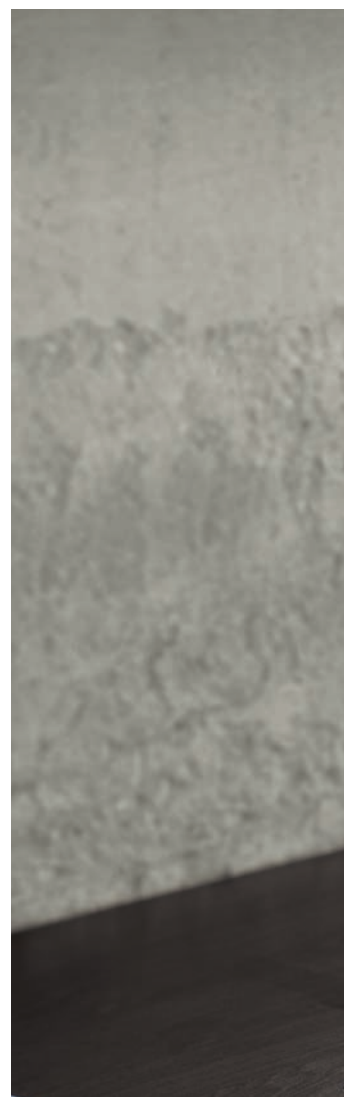



GROHE BLUE®

PURITY YOU CAN TASTE

It all comes down to taste. A representative survey which asked consumers to taste GROHE Blue® water alongside three leading still mineral waters found that GROHE Blue® water tastes better! 73% of consumers assessed the taste of GROHE Blue® water as “fresh”, while only 63 % of those surveyed found the mineral waters to have a “fresh” taste.

GROHE Blue® water doesn't just taste great by itself: it also gives coffee and tea a much more refined and intensive taste.



Clear taste test winner over
3 leading mineral waters
GROHE Blue® tastes fresher!

HOSE 1
GROHE BLUE®
FILTERED
WATER



HOSE 2
UNFILTERED
WATER

SEPARATED INNER WATER WAYS FOR 100 % PURITY AND TASTE

To ensure that GROHE Blue® water does not come into contact with unfiltered water or with metal parts after filtering, the high-quality fitting features two separate waterways – one for the ordinary mains water and one for the purified GROHE Blue® drinking water. This prevents from becoming tainted, preserving the great filtered taste.



HEALTHIER LIVING FROM THE SOURCE

Water is the most precious and fascinating element on earth, the source of life itself, with proven benefits for our health, wellbeing and even appearance. The Deutsche Gesellschaft für Ernährung* recommends that we drink at least two litres of water each day.

Many of us opt to buy bottled water, either because it tastes better than tap or because we believe it is healthier than tap water. However scientific analysis has proved that, due to strict regulations and controls on our drinking water supplies, tap water is at least as good as bottled.

Another reason people spend a small fortune on bottled water is the preference for sparkling water. Now GROHE Blue® delivers all the benefits of bottled water, straight from the tap. It provides a great taste, plus the option of sparkling water too. This makes GROHE Blue® the ultimate solution, not just for good health but for great taste as well.

* German Nutrition Society

GROHE BLUE®

CONVENIENCE ON TAP

Think for a moment about the energy and hassle it takes to keep a supply of bottled water on hand at home. You have to buy it from the supermarket, then lug it from the car to your house. Once there you have to find space to store it out of sight. Then when you've finished it you have to return or recycle the plastic bottles, before starting the whole process again. By installing a GROHE Blue® system in your kitchen you can say goodbye to the hassle and inconvenience of bottled water with no compromises on taste or health. Just turn the tap and enjoy an unrivalled refreshment experience. What could be easier than that?





REDUCING WASTE, RESPECTING NATURE

Water needn't cost the earth

It takes an astonishing 7 litres of water to produce a single litre of bottled mineral water. Not to mention the energy used, CO2 emissions created and the 1.5 million tons of plastic packaging used by the industry each year.

At GROHE we are always working to secure the future of water, our most precious natural resource. This is the driving force behind the development of such products as GROHE Blue®, which help people manage their water and energy consumption with ease.

Sustainable solutions

GROHE Blue® offers a smart alternative which cuts the waste involved in processing bottled water and reduces CO2 emissions by an impressive 83%, according to a study by the University of Goettingen. GROHE Blue® also just needs the 1 litre you drink instead of 7 litres for bottled water, reducing waste by 85%. This makes the GROHE Blue® water system a sustainable alternative to bottled water.

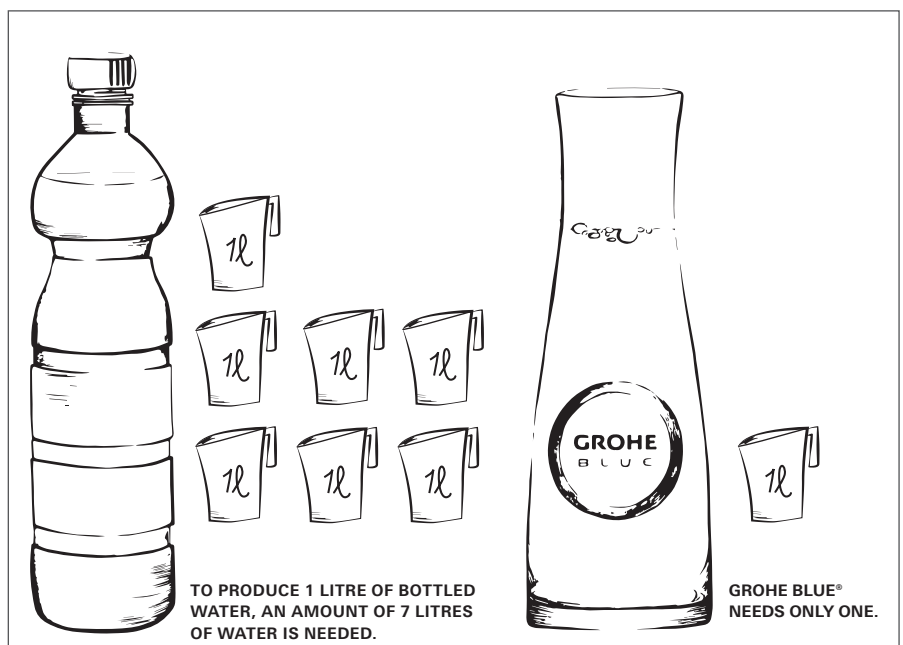

GROHE BLUE®

BWT FILTER TECHNOLOGY

Technology that lets you taste the difference

For our GROHE Blue® system we have worked with BWT, Europe's leading filtered water professionals, to ensure that our system produces an unparalleled refreshing drinking experience.

GROHE Blue® filters use a five-step filtration process to remove even the smallest particles from tap water, while leaving behind all the important minerals that benefit your health.

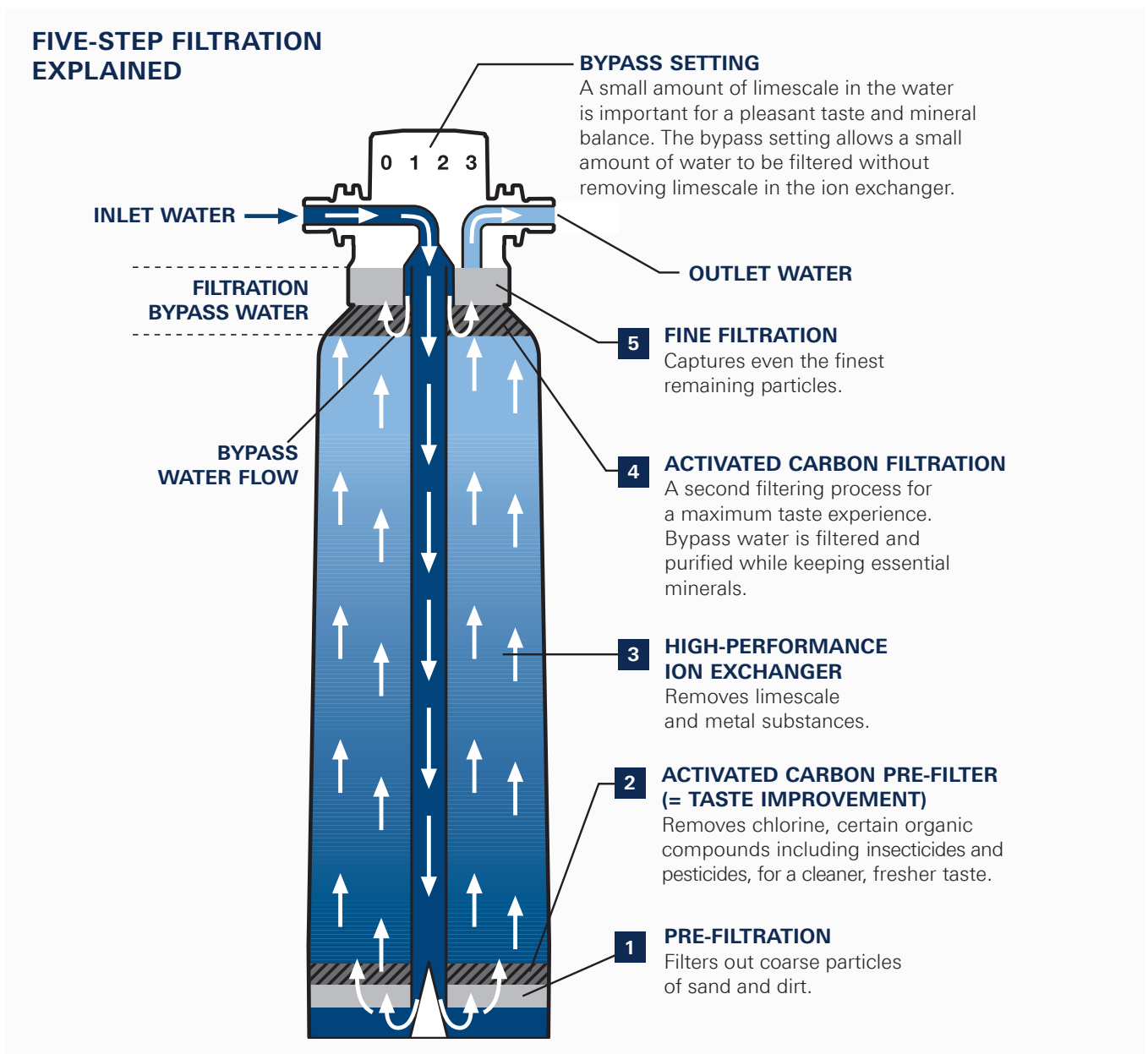



GROHE Blue® systems also offer you a choice of filter size as well as three filter type options, meaning you can get perfect drinking water whether you live in a hard or soft water area.

GROHE BLUE® FILTER – DRINKING WATER, REFINED



Our standard high performance S-Size filter comes with every GROHE Blue® starter set, and replacement filters are available in three sizes – S, M and L. Every GROHE Blue® filter cartridge uses a five-step technology to remove all substances from tap water that impair its taste. Carbon filtration removes chlorine while a high-performance ion exchanger reduces limescale and heavy metals, leaving you with untainted, odour-free drinking water with a pure, fresh taste.

GROHE BLUE® ACTIVATED CARBON FILTER – YOUR SOLUTION FOR SOFT WATER AREAS

Ideal for soft water areas, the activated carbon filter improves the taste by removing chlorine and pesticides but does not filter out carbonate hardness.

GROHE BLUE® MAGNESIUM⁺ FILTER – FOR GREAT TASTE AND HEALTH BENEFITS



Enjoy additional health benefits by choosing the Magnesium⁺ filter model. It uses our five-step filtration process and it also adds magnesium to the water. Something of a tea and coffee connoisseur? Then this is the option for you, with the added magnesium delivering the best-tasting tea and coffee possible.

GROHE BLUE® CHILLED & SPARKLING

Do you like your chilled drinking water still or sparkling? Somewhere in between? With GROHE Blue® the choice is all yours. First the water is filtered to remove impurities. Then it is chilled to create that mountain-fresh taste. When you turn on the tap a simple twist of the handle lets you choose whether still, medium sparkling or sparkling water flows into your glass.

Fresh water tailored to your exact taste, flowing straight from the tap – it's as easy as 1, 2, 3. While the right-hand lever on a GROHE Blue® tap mixes hot and cold water as normal, a handle on the left serves the chilled and filtered water and controls how sparkling your drinking water is, from perfectly still to bursting with bubbles.

An LED indicator in the lever changes colour to let you see your chosen carbonation level at a glance – still, medium sparkling or sparkling – as well as telling you when the filter capacity has fallen below 10% and will soon need to be changed. The water temperature can also be set to your personal taste, individually regulated to between 6 °C and 10 °C.



Initiative LifeCare

**KitchenInnovation
of the Year® 2015**



Best of the Best

Category kitchen furniture and equipment

- ✓ product benefit
- ✓ design
- ✓ innovation
- ✓ ecology
- ✓ functionality

Consumers' Choice



STILL WATER



MEDIUM SPARKLING WATER



SPARKLING WATER

GROHE BLUE[®] CHILLED & SPARKLING

As well as letting you select your ideal taste in drinking water, GROHE Blue[®] technology comes in a variety of design styles and options, making it a perfect fit, whatever your style of kitchen. Select one of four desirable tap styles – the classic GROHE Blue[®] with C- or U-shaped spout, the GROHE Blue[®] K7 or the GROHE Blue[®] Minta.



For those who don't wish to replace their current tap there's GROHE Blue® Mono. With a single pillar tap which sits alongside your existing tap, you can add chilled and sparkling water. It's pure and simple.



31 323 001 / 31 323 DC1

GROHE Blue® Chilled & Sparkling
 Starter Kit comprises: Single-lever mixer with filter function, water filter complete with filter head, cooler and carbonator box



31 324 001 / 31 324 DC1

GROHE Blue® Chilled & Sparkling
 Starter Kit comprises: Single-lever mixer with filter function, water filter complete with filter head, cooler and carbonator box



31 346 001 / 31 346 DC1

GROHE Blue® K7 Chilled & Sparkling
 Starter Kit comprises: Single-lever mixer with filter function, water filter complete with filter head, cooler and carbonator box



31 355 001 / 31 355 DC1

GROHE Blue® K7 Chilled & Sparkling
 Starter Kit comprises: Single-lever mixer with side spray and filter function, water filter complete with filter head, cooler and carbonator box



31 347 002 / 31 347 DC2

GROHE Blue® Minta new Chilled & Sparkling
 Starter Kit comprises: Single-lever mixer with filter function, water filter complete with filter head, cooler and carbonator box



31 302 001 / 31 302 DC1

GROHE Blue® Mono Chilled & Sparkling
 Starter Kit comprises: Single-lever mixer with filter function, water filter complete with filter head, cooler and carbonator box

Colour options:

● 001/002 | StarLight Chrome | ● DC1/DC2 | SuperSteel



GROHE BLUE[®] PURE

Pure water enjoyment. For people who prefer still water only, GROHE Blue[®] Pure is the ultimate solution. Better tasting than tap water, better for the environment than bottled water, and much more convenient for you, GROHE Blue[®] Pure offers drinking water of ultimate purity.





GROHE BLUE® PURE

If pure, filtered, unchilled water is your preference then GROHE Blue® Pure is your solution. While the right-hand lever on GROHE Blue® Pure tap mixes hot and cold water as normal, a handle on the left serves the filtered water. Simply select your tap style from four options - a C- or U-shaped spout, the GROHE Blue® K7 with optional pull-out spray or the GROHE Blue® Minta, or add an elegant GROHE Blue® Mono pillar tap to sit alongside your existing tap - the choice is all yours.





31 087 001 / 31 087 DC1

GROHE Blue® Pure

Starter Kit comprises: Single-lever mixer with filter function, and water filter complete with filter head



31 338 001 / 31 338 DC1

GROHE Blue® Pure

Starter Kit comprises: Single-lever mixer with filter function, and water filter complete with filter head



31 344 001 / 31 344 DC1

GROHE Blue® K7 Pure

Starter Kit comprises: Single-lever mixer with filter function, and water filter complete with filter head



31 354 001 / 31 354 DC1

GROHE Blue® K7 Pure

Starter Kit comprises: Single-lever mixer with side spray and filter function, glass carafe and water filter, complete with filter head



31 345 002 / 31 345 DC2

GROHE Blue® Minta new Pure

Starter Kit comprises: Single-lever mixer with filter function, and water filter complete with filter head



31 301 001 / 31 301 DC1

GROHE Blue® Mono Pure

Starter Kit comprises: Single-lever mixer with filter function, and water filter complete with filter head

Colour options:

● 001/002 | StarLight Chrome | ● DC1/DC2 | SuperSteel



GROHE
SilkMove®



GROHE
StarLight®



Enhanced
Water



Comfort
Height



Swivel
Stop



GROHE BLUE® ACCESSORIES

Make the most of having delicious chilled, filtered water on tap with our range of GROHE Blue® Accessories. From replacement filters for all GROHE Blue® taps, to CO2 cartridges for GROHE Blue® chilled and sparkling, plus our own range of branded GROHE water glasses and carafe, you'll find all you need to enjoy your seamless supply of cool, fresh drinking water in your home.





40 404 001
GROHE Blue® S-Size Filter
40 430 001
GROHE Blue® M-Size Filter
40 412 001
GROHE Blue® L-Size Filter

40 547 001
GROHE Blue®
Activated Carbon filter

40 691 001
GROHE Blue® Magnesium+ filter
replacement filter for GROHE Blue®
for mineralization of the water
with magnesium and premium taste



40 434 001
GROHE Blue® cleaning cartridge
40 694 000
adapter for GROHE Blue® BWT Filterhead
only to be used in combination
with 40 434 001

40 437 000
GROHE Blue® Glass
6 pieces

40 405 000
GROHE Blue® Glass carafe



www.tuv.com
ID: 0000038717

GROHE RED®

STREAMLINE YOUR KITCHEN

Never wait for the kettle to boil again. The innovative GROHE Red® system means you can fill anything, from a mug to a large pot, with kettle-hot water in an instant – and all direct from your kitchen tap. GROHE Red® enables you to still have your standard kitchen mixer, but a second lever provides kettle-hot water on tap.

THE BENEFITS ARE CRYSTAL CLEAR

CLEAN, FRESH TASTE

filtered water heated to 99° C degrees for an exceptional taste experience

CLEAR YOUR WORKTOP

no need for the clutter of a kettle. GROHE Red® fulfils all your water needs from a single tap

NO MORE WAITING

kettle-hot water is always available at the turn of the lever, so waiting for the kettle or pot to boil is a thing of the past

LESS WASTE

you only take the exact amount of hot water you need, so you save on water and energy consumption*



* GROHE Red Duo 8i:
Energy efficiency class water heater: B



GROHE RED®

A SINGLE, SIMPLE SOLUTION

TASTE THE DIFFERENCE

Use GROHE Red® in combination with a GROHE Blue® filter and get fresh just-filtered water served kettle-hot. Enjoy your tea and coffee with a great clean taste. The boiler where the water is heated is made of titanium, which does not impart any metallic taste to the water. It is also highly resistant to corrosion and limescale build-up, meaning a consistently great taste over the lifetime of the tap.

DECLUTTER YOUR KITCHEN

What busy kitchen doesn't need more worktop space? GROHE Red® means you can clear the clutter of your kettle from the worktop and get both hot and cold mixed water plus kettle-hot water, all from the same tap. The system's compact boiler is designed to fit discreetly below the sink, leaving you more counter space and a cleaner, clearer-looking kitchen.





SAVE PRECIOUS TIME

Never wait for a pot of boiling water or a much-needed cup of tea again. We all lead busy lives, and time spent waiting for water to boil all adds to the time spent on chores rather than relaxing. Whether it's cooking pasta, blanching vegetables or preparing a baby's bottle, GROHE Red® cuts out the waiting time with kettle-hot water ready for you, the instant that you want it.

SAVE WATER, SAVE ENERGY

Think for a moment about how often you boil and reboil the kettle. How often do you actually use all the water? When using GROHE Red® you only take the hot water you need, saving precious water and time. In combination with the large GROHE Red® boiler*, which can replace a warm water outlet in the kitchen, the system saves even more water. The large GROHE Red® boiler delivers the heated water for both kettle-hot water and also warm water for the sink mixer, instantly. No more wasted water while you wait for it to reach optimum temperature.

* GROHE Red Duo 8l:
Energy efficiency class water heater: B

GROHE RED®

KETTLE-HOT WATER ON TAP

How many times a day do you fill and boil the kettle?
From the first cup of tea in the morning to a late night
pasta dinner, we boil up water countless times, often
heating far more than we need. With GROHE Red® you
have water heated to 99°C ready when you want it.
It's convenient and saves water and time.





GROHE RED®



CHILDLCK

Safety is paramount in a family kitchen. That's why GROHE Red® taps are designed with a child lock that makes scalding practically impossible: for the boiling water to flow, you must first pull and then turn the left handle. This child-safe feature has been independently tested and certified.



ZERTIFIKAT

Das **ivm** Institut Verpackungsmarktforschung
akkreditiert als Zertifizierungsstelle nach DIN EN 45011 vom



bestätigt hiermit, dass das Testobjekt

GROHE RED®

Heißwasser-Armatur mit Öffnungssicherung

der

Grohe AG
Düsseldorf, Deutschland

als

kindergesichert
bezeichnet werden kann.

Das Testobjekt hat die Prüfung auf Konformität nach einem
angepassten Prüfverfahren entsprechend ISO 8317 (2003) bestanden.

Die Heißwasser-Armatur ist kindergesichert.

Zertifizierungsnummer: **ivm ZERT 22966032008 - 8317**
Datum der Erstzertifizierung: 18.03.2008

Braunschweig, 23.09.2009

Dr. Horst Antonischki
Institutsleiter

ivm Institut Verpackungsmarktforschung GmbH
Friedrich-Seele-Straße 20, 38122 Braunschweig
fon +49(0)531-28509245; fax +49(0)531-28509246
www.ivm-childsafe.de



ZE-22966032008-8317



TECHNOLOGY YOU CAN TRUST



GROHE COOLTOUCH®

GROHE CoolTouch® technology offers you total peace of mind. It insulates the tap so well that you can touch the spout without any risk of scalding, making it far preferable to a kettle in homes with young children.

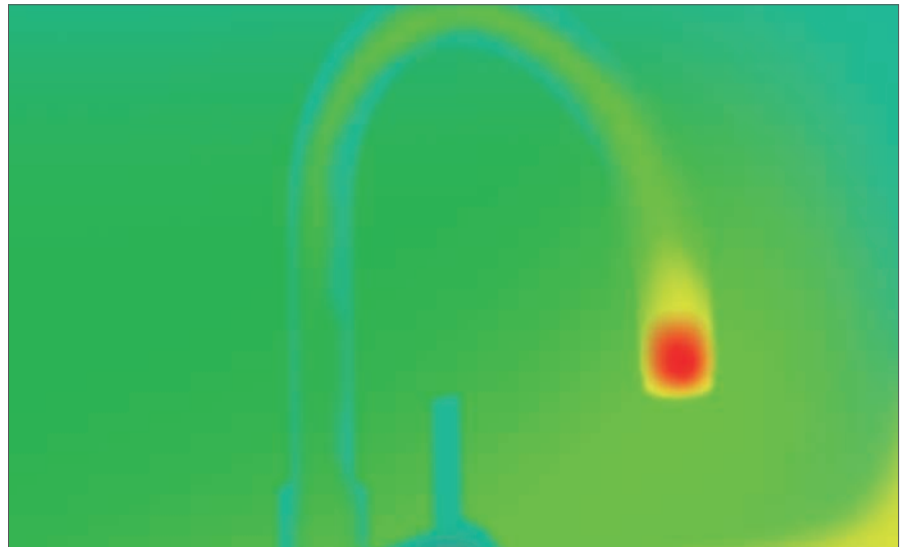

GROHE RED® TITANIUM BOILER

All boilers in our GROHE Red® collection are made from titanium. Unlike stainless steel and copper, two metals traditionally used for boilers, titanium is highly resistant to corrosion and limescale build-up – ensuring perfect performance over a lifetime. It also guarantees that your water is free of any metallic taste.

GROHE RED® DUO

Kettle-hot water – optionally filtered – plus mixed hot and cold water: GROHE Red® Duo means you can have it all covered in just one tap, replacing your standard kitchen tap. When combined with the larger Red® boiler, it is even ideal for kitchens without a hot water supply. It instantly delivers warm water for the kitchen mixer without waiting for water to heat up. Available in two spout shapes, it is also the perfect match with a GROHE Blue® Mono water system.





30 058 000 / 30 058 DC0
 GROHE Red® Duo
 tap and boiler 4 litres



30 153 000 / 30 153 DC0
 GROHE Red® Duo
 tap and boiler 4 litres



40 404 001
 GROHE Blue® S-Size Filter
40 430 001
 GROHE Blue® M-Size Filter
40 412 001
 GROHE Blue® L-Size Filter

Colour options:

● 000 | StarLight Chrome | ● DC0 | SuperSteel



**GROHE
 SilkMove®**



**GROHE
 StarLight®**



**GROHE
 CoolTouch®**



**Enhanced
 Water**



**Child
 Lock**



**Titanium
 Inside**



**Comfort
 Height**



**Swivel
 Stop**



* GROHE Red Duo 8l:
 Energy efficiency class water heater: B

GROHE RED[®] MONO

Add a GROHE Red[®] Mono to your existing kitchen tap and say goodbye to your kettle for good. The smaller Mono tap supplies kettle hot water only and is the perfect combination with a GROHE Blue[®] Duo water system. Choose from two elegant spout shapes to find the perfect fit for your kitchen.





30 060 000
GROHE Red® Mono
tap and boiler 8 litres

RRP £1,318.19*

30 155 000
30 155 DC0
GROHE Red® Mono
tap and boiler 4 litres

RRP £1,344.56*
RRP £1,451.06*



40 404 001
GROHE Blue® S-Size Filter
40 430 001
GROHE Blue® M-Size Filter
40 412 001
GROHE Blue® L-Size Filter

Colour options:

● 000 | StarLight Chrome | ● DC0 | SuperSteel



**GROHE
SilkMove®**



**GROHE
StarLight®**



**GROHE
CoolTouch®**



**Enhanced
Water**



**Child
Lock**



**Titanium
Inside**



**Comfort
Height**



* GROHE Red 8l:
Energy efficiency class water heater: B

GROHE BLUE®

A SMART SOLUTION FOR YOUR OFFICE KITCHEN

A busy office runs on... tea, coffee and lots of fresh water. From water-cooler moments to brainstorming sessions powered by a pot of hot coffee, drinking water is at the heart of the day-to-day life of any company. Now you can find a smarter solution that saves your company time, energy and money, while offering great taste and unbelievable convenience, with GROHE's water systems.



**GROHE
BLUE®**

17.96 gr.* CO₂/l

*Total consumption of 33.000 litres water (in a company with 30 employees; 1 litre/person/day; over a period of 5 years).
Source: CO₂ Carbon footprint study from Goettingen university, Germany 2013/2014



ENJOY FRESH THINKING WITH GROHE BLUE®

With a GROHE Blue® water system your company can enjoy the benefits of filtered chilled and sparkling water on tap:

BEST VALUE FOR MONEY

GROHE Blue® filters, chills and even carbonates tap water, so no more expensive and disruptive deliveries of expensive bottled water.

MOST ENVIRONMENTALLY SUSTAINABLE

With no plastic bottles and lower CO2 emissions* than for normal bottled water GROHE Blue® will reduce your office's carbon footprint.

The University of Goettingen made a detailed analysis of the influence of drinking water production on our environment. With only 17.96 gr per litre, GROHE Blue® saves up to 62.4% CO2 emissions compared to gallon water and 83.4% compared to bottled water.

FREE UP PRECIOUS SPACE

GROHE Blue® means there is no more need to set aside vast amounts of valuable office space for storing bottled water.

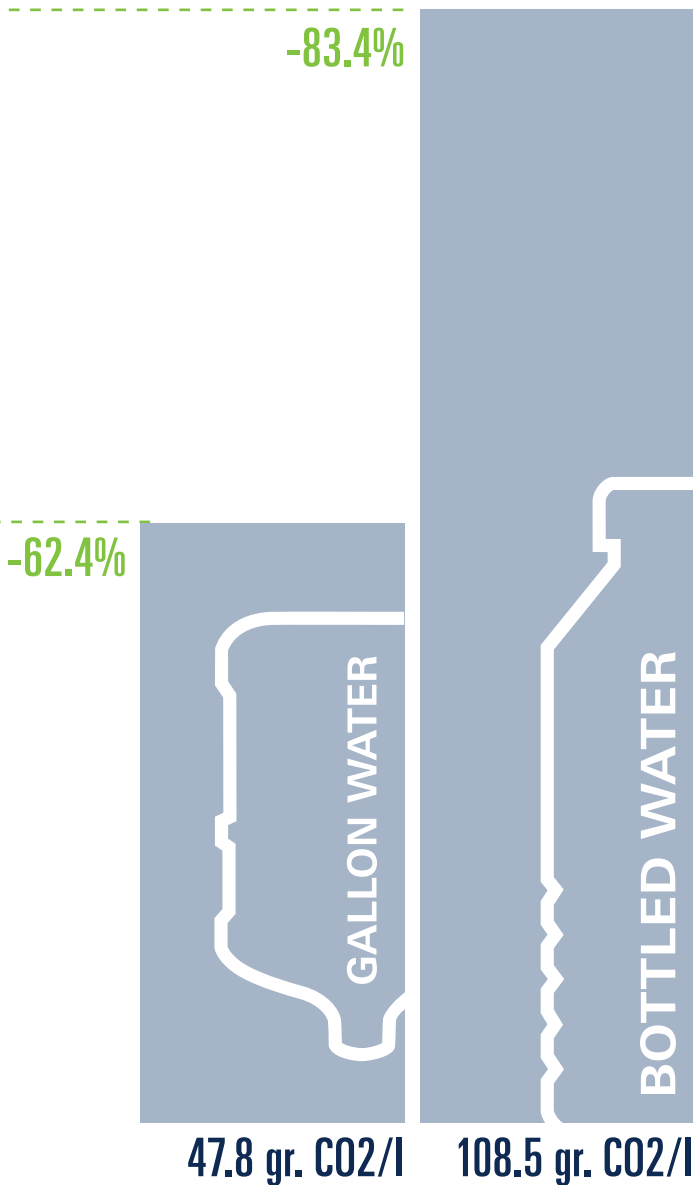

GROHE RED®

SAVE TIME AND MONEY IN YOUR OFFICE KITCHEN

GROHE Red® everyone in the company can enjoy kettle-hot filtered water direct from the tap.

NO MORE WAITING

Don't fear the tea round! When using GROHE Red® you can say goodbye to waiting for the kettle to boil. Instead enjoy pure water heated to 99°C, always available at the moment you want it.

A CLEANER, CLEARER KITCHEN

There is no need for a kettle your kitchen will be less cluttered and easier to keep clean and tidy.

THE MONEY-SAVING OPTION

As you only heat the exact amount of water that you need, running a GROHE Red® tap is cheaper than running a wasteful kettle.



Build a powerful team with GROHE Blue® and GROHE Red® combined

Combine both the GROHE Blue® and Red® systems for double the benefits. You can opt either for a GROHE Blue® Duo tap in combination with a GROHE Red® Mono, or choose the GROHE Red® Duo and add a GROHE Blue® Mono. The choice is yours, the benefits will be felt throughout the company.

ALREADY @ HOME IN WELL-KNOWN COMPANIES



1 MIELE Headquarter, Guetersloh, Germany | 2 Vodafone Headquarter, Duesseldorf, Germany | 3 Vodafone Office, Munich, Germany



GROHE PREMIUM LIFESTYLE COLLECTIONS

THE SOURCE OF INDIVIDUALITY

At GROHE we understand that your kitchen is a reflection of you. It's more than just a space to cook and clean – it's where you express yourself, enjoy yourself and even stretch yourself. That's why we have created a range of products that allow your inner home chef to shine, with professional-grade functionality that won't let you down, tailored features to help you perform better and intelligent design that reflects your personal taste. GROHE Premium Lifestyle Collections your kitchen can be as individual as you are.

A tantalising fusion of perfect design, innovative features and professional-level functionality, designed to enamour home chefs.





GROHE PREMIUM LIFESTYLE COLLECTIONS

GROHE
K7



54

GROHE
ZEDRA
TOUCH



62

GROHE
MINTA
TOUCH



64

GROHE
K7
FOOTCONTROL



68

GROHE
ESSENCE
FOOTCONTROL



70

GROHE
ZEDRA



72

GROHE
MINTA



76

GROHE
K4

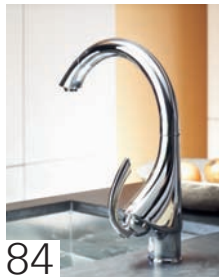

84

GROHE
ESSENCE



86

GROHE
EUROCUBE



92

GROHE
AMBI



96

GROHE
PARKFIELD

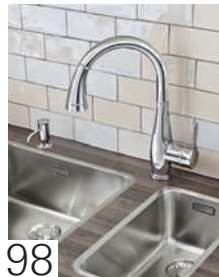

98





GROHE K7

Bring the appealing style of a professional tap into your home and discover a new world of power and performance. The K7 collection has been designed with the passionate cook in mind, and created with the help of professional chefs, offering you complete flexibility with a stunning centrepiece tap. A number of products in the range we know you'll love their combination of aesthetic excellence with unrivalled functionality.





GROHE K7

Sleek and striking, the K7 range offers a professional-style kitchen tap in two spout heights, featuring a 360° turnable spring arm for maximum flexibility and a solid metal spray which allows for easy switching between mousseur and spray function. The K7 range also offers a swivel spout and variants with extractable dual spray and side sprays which guarantee the highest performance levels as well as stunning design. The K7 collection offers the ultimate flexibility for kitchens where performance really matters.





32 175 000 / 32 175 DC0
Sink mixer



32 176 000 / 32 176 DC0
Sink mixer
with pull-out spray



32 179 000 / 32 179 DC0
Sink mixer
with side spray



32 950 000 / 32 950 DC0
Professional sink mixer



31 379 000 / 31 379 DC0
Professional sink mixer

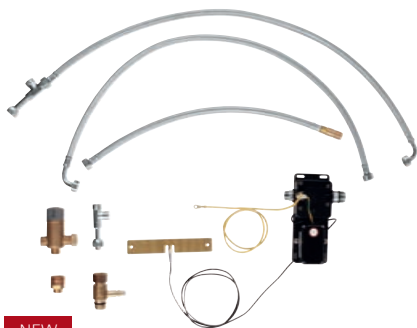

NEW

30 309 000
Retro-Fit set
for upgrading any GROHE pull-out kitchen
tap with FootControl technology



40 535 000 / 40 535 DC0
Cosmopolitan soap dispenser
for liquid soaps
storage bin 0.4 l

Colour options:

● 000 | StarLight Chrome | ● DC0 | SuperSteel



GROHE
SilkMove®



GROHE
StarLight®



Professional
Spray



Pull-Out
Dual Spray



Speed
Clean



Comfort
Height



Swivel
Stop



Easy
Dock



GROHE EASY TOUCH / FOOT CONTROL



LIBERATE YOUR HANDS

Kitchens are hands-on places, where multi-tasking is a must. Why not make life easier for yourself with a GROHE touch-activated tap? We've developed a choice of two innovative solutions that let you control the flow of water without using your hands, making your kitchen more hygienic, convenient and instinctive to use. GROHE Touch taps can be activated with a simple touch of the wrist or elbow, while GROHE Foot Control taps turn the flow of water on and off with just a tap of your foot on the base unit. Leave your hands free and keep your tap sparkling clean. Change the way you control your kitchen with just a single touch.



Ideal for busy kitchens where there's always something going on, GROHE EasyTouch and FootControl are hygienic and convenient, and both come without any compromise on style. GROHE'S innovative touch technologies you can spend less time cleaning and more time cooking, baking, kneading, finger-painting...living.

GROHE EASYTOUCH





LOVE AT FIRST TOUCH

The kitchen is the heart of your life at home – and let's face it, sometimes life gets messy. With GROHE's innovative Touch taps sticky fingers won't slow you down and cross-contamination is a thing of the past. Hidden GROHE technology lets you start and stop the flow of water with a single tap of your arm, wrist or the back of your hand, anywhere on the spout. No more greasy fingerprints or struggling to turn a lever with your elbow.



GROHE ZEDRA TOUCH

Put the sweeping, sensual power of water at the centre of your kitchen with the Zedra Touch. Zedra's distinctive fluted swivel spout and beautifully tactile lever combine ergonomic design with visual flair. The addition of GROHE's EasyTouch technology enables you to also control the water flow with just one touch. Choose your Touch function in the standard-version with an integrated mixing unit or upgrade with an under-sink Grohtherm Micro thermostat for perfectly controlled warm water and no danger of scalding.





30 219 001 / 30 219 DC1
Electronic Sink Mixer
with pull-out dual spray



32 294 001 / 32 294 DC1
Electronic Sink Mixer
with pull-out dual spray



34 487 000
Grotherm Micro



40 553 000 / 40 553 DC0
Zedra soap dispenser
for liquid soaps
storage bin 0.4 l

Colour options:

● 000/001 | StarLight Chrome | ● DC0/DC1 | SuperSteel



GROHE
SilkMove®



GROHE
StarLight®



Easy
Touch



Pull-Out
Dual Spray



Speed
Clean



Comfort
Height



Forward
Rotating Lever



GROHE MINTA TOUCH

Modern and minimal, the sensual curves and arcs of GROHE's Minta range will never go out of fashion, and sit perfectly in any contemporary kitchen. Now you can add the ultimate in cleanliness and convenience with the EasyTouch model. Letting you turn the water flow on and off with a touch of your arm, Minta Touch puts you in control. Choose your Touch function in the standard-version with an integrated mixing unit or upgrade with an under-sink Grohtherm Micro thermostat for perfectly controlled warm water and no danger of scalding.





Minta Touch has been approved and recommended for use by disabled people and the elderly. It has been tested and rated "good" by the Institute for Gerontechnik for Barrier Free Building, due to its one-touch operating technology and ergonomic design.



31 358 001 / 31 358 DC1
Electronic Sink Mixer
C-spout
with pull-out mousseur spray



31 360 001 / 31 360 DC1
Electronic Sink Mixer
L-spout
with pull-out mousseur



34 487 000
Grotherm Micro



40 535 000 / 40 535 DC0
Cosmopolitan soap dispenser
for liquid soaps
storage bin 0.4 l

Colour options:

● 000/001 | StarLight Chrome | ● DC0/DC1 | SuperSteel



GROHE SilkMove®



GROHE StarLight®



Easy Touch



Pull-Out MousseurSpray



Pull-Out Mousseur



Speed Clean



Comfort Height



Forward Rotating Lever



GROHE FOOTCONTROL

For kitchens where time is of the essence and convenience is a must, why not go hands-free? GROHE's new FootControl taps can be turned on and off with a gentle tap of your foot on the base unit, leaving your hands free and your tap spotless at all times. Three of our most popular taps now come with this innovative FootControl technology, or you can retro-fit the feature to any GROHE pull-out kitchen tap. To say goodbye to germs, mess and hassle, simply tap your feet!





**LIBERATE
YOUR HANDS
TAP YOUR FEET**



GROHE K7 FOOTCONTROL

Unlock the professional potential of your kitchen with the K7 FootControl tap. Enjoy the high-performance of the K7's professional spray feature and extractable hose combined with the convenience of foot activation technology. The tap's crisp architectural styling makes it a design feature in itself, but the exceptional pro-level features mean it's more than a match for any task. For busy kitchens where efficiency is a must, the K7 FootControl tap puts you in total control – and leaves your hands free for other tasks.





30 312 000 / 30 312 DC0
Electronic Sink Mixer
with professional spray

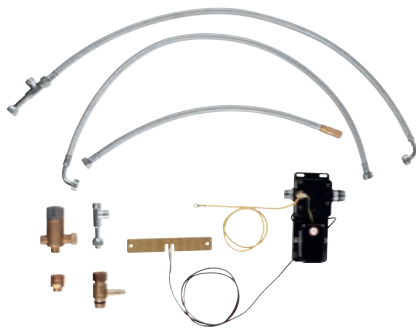

30 309 000
Retro-Fit set
for upgrading any GROHE pull-out kitchen
tap with FootControl technology



40 535 000 / 40 535 DC0
Cosmopolitan soap dispenser
for liquid soaps
storage bin 0.4 l

Colour options:

● 000 | StarLight Chrome | ● DC0 | SuperSteel



GROHE
SilkMove®



GROHE
StarLight®



Foot
Control



Professional
Spray



Speed
Clean



Comfort
Height



Forward
Rotating Lever



GROHE ESSENCE FOOTCONTROL

Introduce the purity of minimalism to your kitchen while enjoying the effortless functionality of hands-free operation with GROHE's Essence FootControl tap. The sleek, simple lines of our Essence tap are the perfect complement to a contemporary kitchen, while the one-touch FootControl lets you keep your hands free and your tap germ-free. Pull-out dual spray feature and the dazzling, durable GROHE StarLight® finish and the Essence FootControl is the perfect choice for a fuss-free kitchen design.



30 311 000 / 30 311 DC0
Electronic Sink Mixer
L-spout
with professional spray

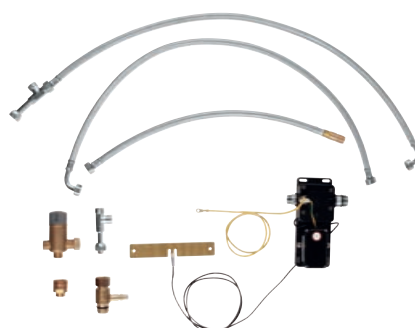

30 309 000
Retro-Fit set
for upgrading any GROHE pull-out kitchen
tap with FootControl technology



40 535 000 / 40 535 DC0
Cosmopolitan soap dispenser
for liquid soaps
storage bin 0.4 l

Colour options:

● 000 | StarLight Chrome | ● DC0 | SuperSteel



GROHE
SilkMove®



GROHE
StarLight®



Foot
Control



Pull-Out
Dual Spray



Speed
Clean



Comfort
Height



Forward
Rotating Lever



NEW



GROHE ZEDRA

Contemporary elegance meets total convenience with Zedra. The flared spout echos the natural flow of water, and also contains a pull-down spray to make cleaning easier. The ergonomically-designed lever handle invites you to control your water flow with precision, while GROHE engineering guarantees smooth functionality that will last a lifetime.





GROHE ZEDRA

GROHE's Zedra features a dual-control button with locking feature, which lets you switch effortlessly between spray modes and a SpeedClean nozzle makes removing limescale a breeze. Choose between a high-gloss GROHE StarLight® chrome finish or the anti-bacterial properties of RealSteel for a tap that is as durable as it is beautiful.





32 294 001 / 32 294 SD1
Sink mixer
with pull-out dual spray



32 553 000 / 32 553 SD0
Sink mixer
with pull-out dual spray



32 296 000 / 32 296 SD0
Sink mixer
with pull-out mousseur spray

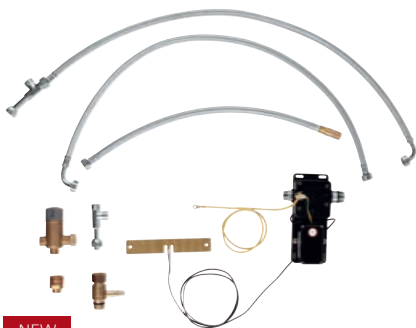

NEW

30 309 000
Retro-Fit set
for upgrading any GROHE pull-out kitchen
tap with FootControl technology



40 553 000 / 40 553 DC0
Zedra soap dispenser
for liquid soaps
storage bin 0.4 l

Colour options:

● 000/001 | StarLight Chrome | ● SD0/SD1 | Stainless Steel | ● DC0 | SuperSteel



GROHE
SilkMove®



GROHE
StarLight®



Pull-Out
Dual Spray



Pull-Out
Mousseur Spray



OpenWater
Heater



Stop
Valve



Comfort
Height



Forward
Rotating Lever



Easy
Dock



GROHE MINTA

Every family likes variety from the kitchen and that is exactly what Minta delivers. All Minta taps share one unmistakable feature, which is the minimalist cylindrical shape. GROHE's most popular kitchen collection is now filled with additional innovative features like the new extractable dual-spray. The collection is available in GROHE StarLight® chrome and in highly resistant SuperSteel finish.





GROHE MINTA

A stylish, minimal kitchen doesn't mean compromising on performance. The first thing you'll notice about GROHE's Minta tap is its sleek, clean silhouette, perfect for a contemporary kitchen. What you'll enjoy day after day is its fantastic flexibility, with a pull-out spray head with dual spray control it makes cleaning, rinsing and prepping easy, letting you get the most out of your kitchen.

**DESIGN AND
FEATURES
IN PERFECT
HARMONY**





GROHE MINTA

Our most popular tap combines a distinctively minimal silhouette with huge flexibility and innovative features. From a model with a swivel spout to one with a pull-out mousseur or the new retractable dual-spray head, plus two choices of durable finish, GROHE Minta puts the choice in your hands.





31 375 000 / 31 375 DC0
Sink mixer L-spout



32 168 000 / 32 168 DC0
Sink mixer L-spout
with pull-out mousseur
31 397 000
for open water heater



30 274 000 / 30 274 DC0
Sink mixer L-spout
with pull-out dual spray

NEW



32 488 000 / 32 488 DC0
Sink mixer U-spout



32 067 000 / 32 067 DC0
Sink mixer U-spout
with pull-out mousseur



32 322 000 / 32 322 DC0
Sink mixer U-spout
with pull-out mousseur spray

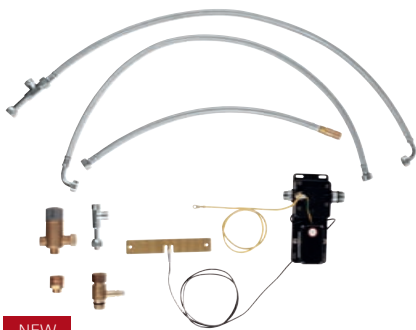

NEW

30 309 000
Retro-Fit set
for upgrading any GROHE pull-out kitchen
tap with FootControl technology



40 535 000 / 40 535 DC0
Cosmopolitan soap dispenser
for liquid soaps
storage bin 0.4 l

Colour options:

● 000 | StarLight Chrome | ● DC0 | SuperSteel



GROHE
SilkMove®



GROHE
StarLight®



Pull-Out
Dual Spray



Pull-Out
MousseurSpray



Pull-Out
Mousseur



OpenWater
Heater



Comfort
Height



Easy
Dock



GROHE MINTA

The classic Minta C-spout also offers the choice of three functions: swivel spout, pull-out mousseur or pull-out mousseur spray, as well as two choices of durable steel or chrome finish.





● ● ● ● ●
32 917 000 / 32 917 DC0
 Sink mixer C-spout
32 511 000
 for open water heater



● ● ● ● ●
32 918 000 / 32 918 DC0
 Sink mixer C-spout
 with pull-out mousseur
32 918 00E
 with GROHE EcoJoy



● ● ● ● ●
32 321 000 / 32 321 DC0
 Sink mixer C-spout
 with pull-out mousseur spray

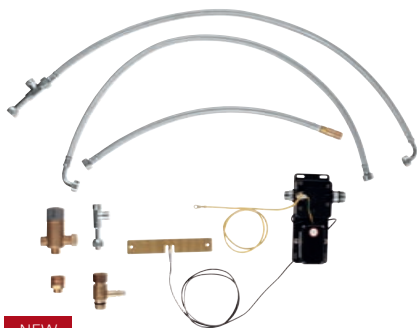

NEW
30 309 000
 Retro-Fit set
 for upgrading any GROHE pull-out kitchen
 tap with FootControl technology



● ● ● ● ●
40 535 000 / 40 535 DC0
 Cosmopolitan soap dispenser
 for liquid soaps
 storage bin 0.4 l

Colour options:

● 000 | StarLight Chrome | ● DC0 | SuperSteel | ○ LS0 | MoonWhite | ● KS0 | Velvet Black



GROHE
SilkMove®



GROHE
StarLight®



Pull-Out
MousseurSpray



Pull-Out
Mousseur



OpenWater
Heater



Comfort
Height



Easy
Dock



GROHE K4

Enjoy a kitchen experience that is dramatically different. The K4 not only looks unlike any other tap, it also offers specialist performance in the heart of your home. The dramatic arcing exterior conceals a 360° swivel spout and pull-out spray that gives you total freedom and convenience.





● ●
33 782 000 / 33 782 SD0
 Sink mixer
 with pull-out dual spray



● ●
33 786 000 / 33 786 SD0
 Sink mixer
 with pull-out mousseur

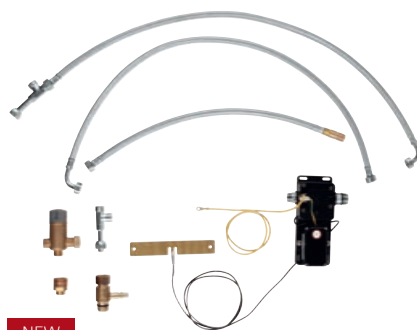

NEW
30 309 000
 Retro-Fit set
 for upgrading any GROHE pull-out kitchen
 tap with FootControl technology



● ●
40 553 000 / 40 553 DC0
 Zedra soap dispenser
 for liquid soaps
 storage bin 0.4 l

Colour options:

● 000 | StarLight Chrome | ● SD0 | Stainless Steel | ● DC0 | SuperSteel



**GROHE
SilkMove®**



**GROHE
StarLight®**



**Pull-Out
Dual Spray**



**Pull-Out
Mousseur**



**Comfort
Height**



**Easy
Dock**



GROHE ESSENCE

Discover a minimal style that's full of warmth with GROHE's new Essence tap. The slim architectural shape is enhanced with organic design elements ideal for a contemporary kitchen, inviting touch and interaction for the sensual chef.





GROHE ESSENCE

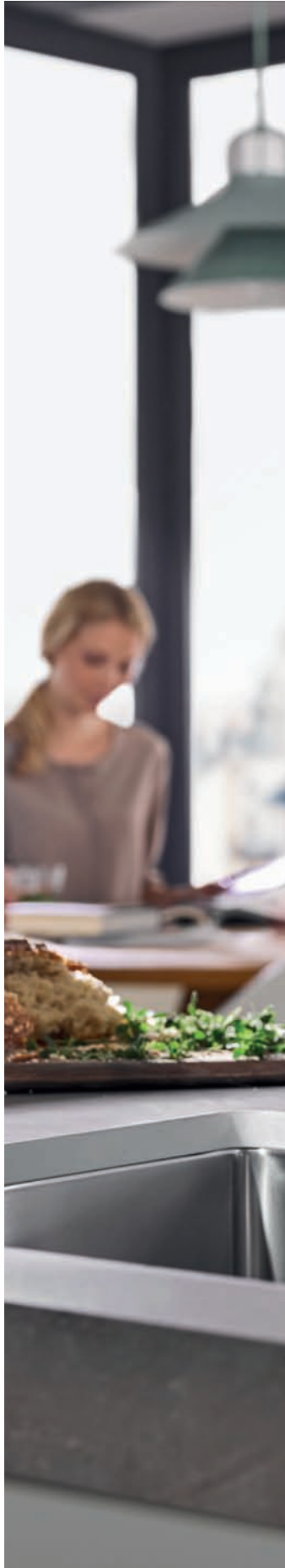



DELICATE DESIGN, POWERFUL FEATURES

A distinctive, delicate body conceals advanced technology in the new Essence tap. The cylindrical body is super-slim, thanks to a new small cartridge, offering pure elegance without compromise. A solid metal spray head guarantees life-long performance, and you can switch easily between two spray patterns with a toggle function that puts flexibility to the fore.



GROHE ESSENCE

Choose between two models, one with swivel spout and one with a solid metal pull-out spray, which offers easy switching between mousseur and spray. Available in a choice of two great-looking and durable finishes and you'll see that great design doesn't have to mean compromise on functionality.



30 269 000 / 30 269 DC0
Sink mixer
high spout



30 270 000 / 30 270 DC0
Sink mixer high spout
with pull-out dual spray

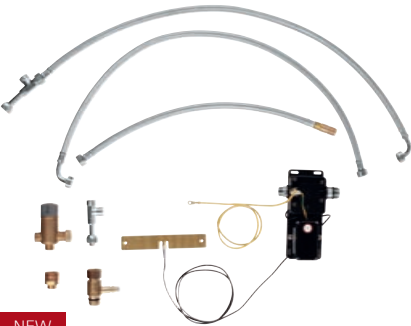

30 309 000
Retro-Fit set
for upgrading any GROHE pull-out kitchen
tap with FootControl technology



40 535 000 / 40 535 DC0
Cosmopolitan soap dispenser
for liquid soaps
storage bin 0.4 l

Colour options:
● 000 | StarLight Chrome | ● DC0 | SuperSteel



GROHE
SilkMove®



GROHE
StarLight®



Pull-Out
Dual Spray



Comfort
Height



Swivel
Stop



Forward
Rotating Lever



Easy
Dock





GROHE EUROCUBE

Make a statement with GROHE's Cubist masterpiece. The Eurocube's strong lines and solid, architectural shape is perfect for modern kitchens where design is at the forefront. From the lever's cut-out detailing to the new professional-grade features, this is a tap for those who are both style conscious and serious about their cooking.

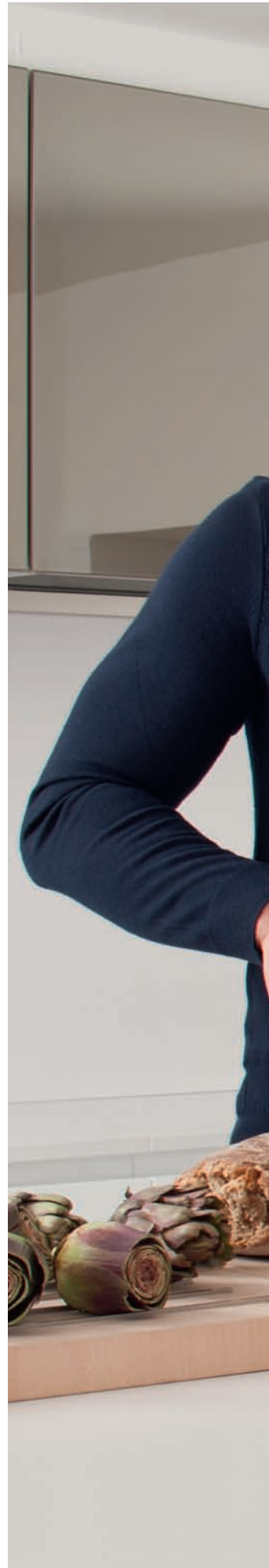

NEW



GROHE EUROCUBE

Eurocube is available in two versions. Choose between a swivel spout model and the new semi-professional mixer with pull-out dual spray. Mounted on a spring hose with 360° movement, the head switches easily between two spray options, giving ultimate flexibility and great high-spec performance.





31 255 000
Sink mixer



NEW

31 395 000 / 31 395 DC0
Professional sink mixer

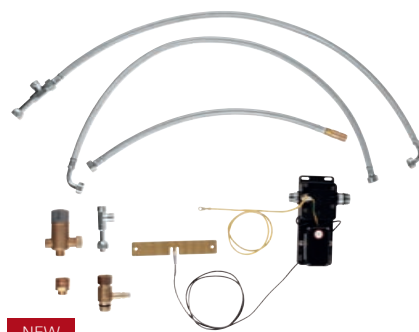

NEW

30 309 000
Retro-Fit set
for upgrading any GROHE pull-out kitchen
tap with FootControl technology

Colour options:

● 000 | StarLight Chrome | ● DC0 | SuperSteel



**GROHE
SilkMove®**



**GROHE
StarLight®**



**Professional
Spray**



**Comfort
Height**



**Forward
Rotating Lever**



GROHE AMBI

Opt for a contemporary classic with the Ambi tap range. Advanced engineering meets subtle design options in Ambi's two models, both with the comfortable functionality of twin forward-rotating levers.





30 189 000
Contemporary
2 handle sink mixer



30 190 000
Cosmopolitan
2 handle sink mixer



40 536 000
Contemporary soap dispenser
for liquid soaps storage bin 0.4 l



40 535 000
Cosmopolitan soap dispenser
for liquid soaps storage bin 0.4 l



GROHE
SilkMove®



GROHE
StarLight®



Comfort
Height



Forward
Rotating Lever



GROHE PARKFIELD

Solid and organic, the Parkfield mixer is perfect for hands-on chefs. It features a single tactile lever controlling the flow and a solid pull-out head that lets you switch quickly between two spray patterns. A Speed Clean nozzle feature and taller spout for more comfort, Parkfield offers a practical, powerful solution for all kitchens.





30 215 000 / 30 215 DC0
Sink mixer
with pull-out dual spray

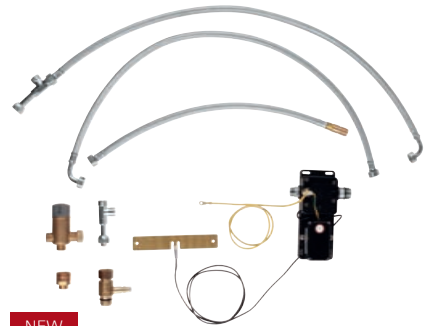

NEW

30 309 000
Retro-Fit set
for upgrading any GROHE pull-out kitchen
tap with FootControl technology



40 537 000 / 40 537 DC0
Authentic soap dispenser
for liquid soaps
storage bin 0.4 l

Colour options:

● 000 | StarLight Chrome | ● DC0 | SuperSteel



GROHE
SilkMove®



GROHE
StarLight®



Pull-Out
Dual Spray



Speed
Clean



Comfort
Height



Forward
Rotating Lever



Easy
Dock



GROHE PERFORMANCE LINES

THE SOURCE OF FUNCTIONALITY

Get the most out of your busy kitchen with GROHE's Performance Lines. Created to offer a huge range of practical features to make any kitchen easier, safer and more enjoyable to use, you'll bound to find the perfect solution. With a variety of modern designs, plus versatile height and installation options, GROHE Performance Lines offer great value and functionality that will enhance your life every day.





GROHE PERFORMANCE LINES

GROHE
EUROPLUS



GROHE
EURODISC
COSMOPOLITAN



GROHE
EURODISC



GROHE
CONCETTO



GROHE
EUROSTYLE
COSMOPOLITAN



GROHE
EUROSMART
COSMOPOLITAN

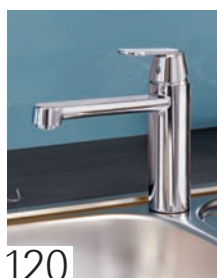

GROHE
EUROSMART



GROHE
BAU



GROHE
COSTA S

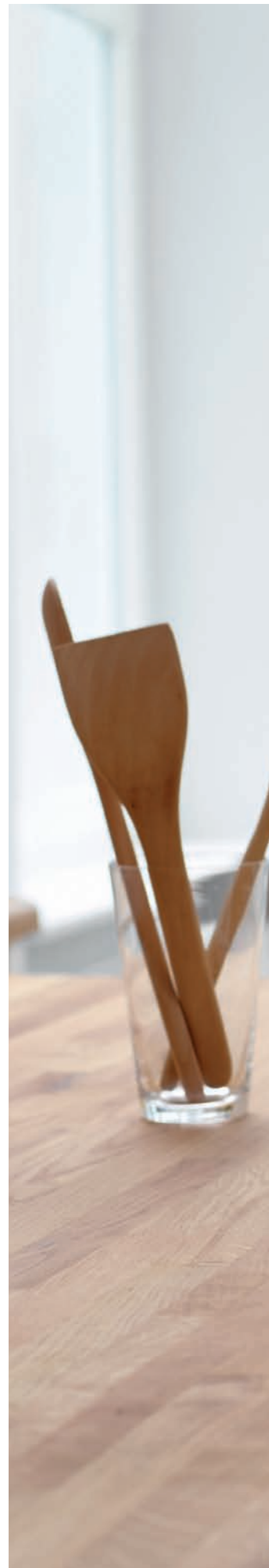



GROHE EUROPLUS

Simple, streamlined and modern – GROHE's Europlus has a universal appeal. A sculpted body flows seamlessly into a smooth lever handle, tilted at a 7 degree angle for easy handling and optimal ergonomics. Choose from a low or medium-height spout model, and add a pull-out dual spray for even greater flexibility.





33 930 002
Sink mixer medium spout



33 933 002
Sink mixer medium spout
with pull-out dual spray



32 941 002
Sink mixer low spout



32 942 002
Sink mixer low spout
with pull-out dual spray

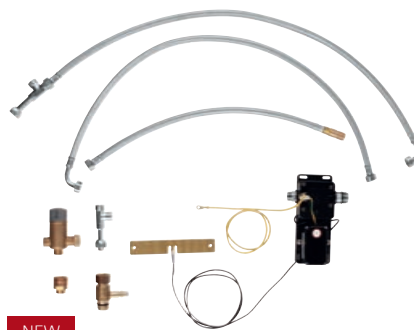

30 309 000
Retro-Fit set
for upgrading any GROHE pull-out kitchen
tap with FootControl technology



40 536 000
Contemporary soap dispenser
for liquid soaps
storage bin 0.4 l



GROHE
SilkMove®



GROHE
StarLight®



Pull-Out
Dual Spray



OpenWater
Heater



Speed
Clean



Comfort
Height



Easy
Dock

GROHE EURODISC COSMOPOLITAN

Proving that intensely practical design can work in balance with attractive, modern styling, Eurodisc Cosmopolitan has been created to be the perfect solution for any kitchen setting. You'll love the variety on offer, making for easy installation and even easier use, while a tapering spout and slightly angled lever add to the sleek effect.

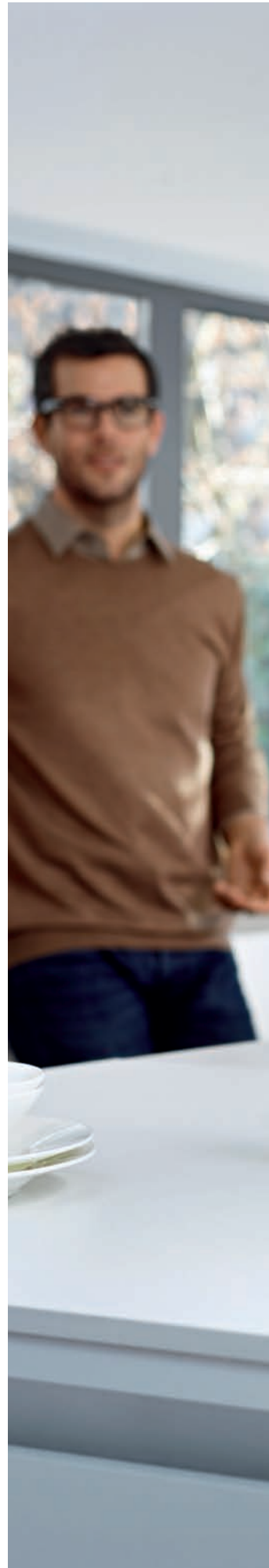



GROHE EURODISC COSMOPOLITAN

Get the balance just right in your kitchen with our Eurodisc Cosmopolitan range. From low to high spouts, pull-out dual spray and extractable mousseur options, Eurodisc Cosmopolitan will let you find harmony between elegant good-looks and practical features.





33 770 002
Sink mixer medium spout
31 206 002
for open water heater



32 257 002
Sink mixer medium spout
with pull-out dual spray



33 312 002
Sink mixer medium spout
pre-window



31 237 002
Sink mixer medium spout
with shut-off valve



32 259 002
Sink mixer high spout



31 122 002
Sink mixer high spout
with pull-out mousseur

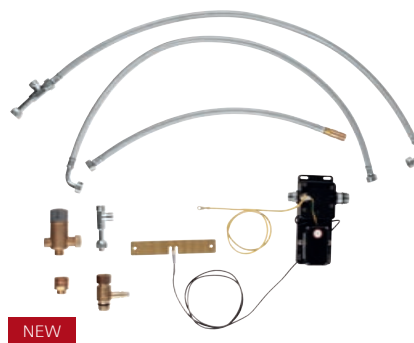

30 309 000
Retro-Fit set
for upgrading any GROHE pull-out kitchen
tap with FootControl technology



40 535 000
Cosmopolitan soap dispenser
for liquid soaps storage bin 0.4 l



GROHE
SilkMove®



GROHE
StarLight®



Pull-Out
Dual Spray



Pull-Out
Mousseur



OpenWater
Heater



Stop
Valve



Pre
Window



Comfort
Height



Swivel
Stop



Easy
Dock

GROHE EURODISC

Smart design paired with practical features – the Eurodisc delivers on all fronts. A swivel spout makes daily tasks easier, and the fin-shaped lever can be operated using just two fingers, giving you great control with minimal effort. Add an optional pull-out dual spray and you've got a great all-round solution for any busy kitchen.





33 770 001
Sink mixer low spout

32 257 001
Sink mixer low spout
with pull-out dual spray

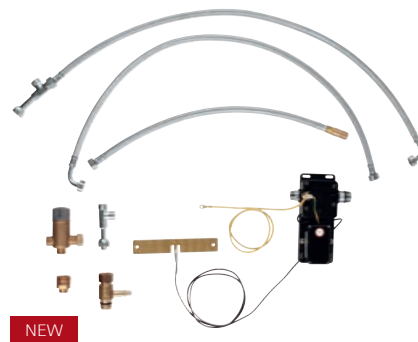

NEW

30 309 000
Retro-Fit set
for upgrading any GROHE pull-out kitchen
tap with FootControl technology



40 536 000
Contemporary soap dispenser
for liquid soaps
storage bin 0.4 l



GROHE
SilkMove®



GROHE
StarLight®



Pull-Out
Dual Spray



Swivel
Stop



Easy
Dock

GROHE CONCETTO

Making distinctive design accessible for all, Concetto is ideal for kitchens where style and practicality have to go hand-in-hand. Design-lovers will adore the distinctive silhouette based on a series of cylinders, while the hard-working cook will appreciate the finger-tip control and great performance.





● ● **31 483 001 / 31 483 DC1**
Sink mixer high spout
with pull-out mousseur spray



● ● **32 661 001 / 32 661 DC1**
Sink mixer high spout



● ● **32 663 001 / 32 663 DC1**
Sink mixer high spout
with pull-out mousseur



● **32 666 001**
Sink mixer high spout
with shut-off valve

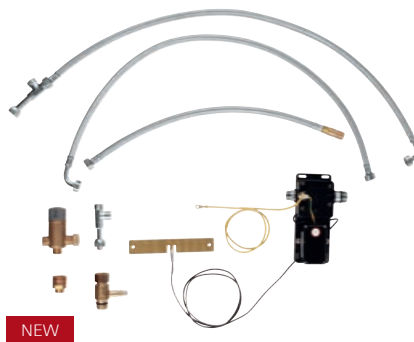

● **30 309 000**
Retro-Fit set
for upgrading any GROHE pull-out kitchen
tap with FootControl technology



● ● **40 535 000 / 40 535 DC0**
Cosmopolitan soap dispenser
for liquid soaps
storage bin 0.4 l

Colour options:

● 000/001 | StarLight Chrome | ● DC0/DC1 | SuperSteel



GROHE
SilkMove®



GROHE
StarLight®



Pull-Out
MousseurSpray



Pull-Out
Mousseur



OpenWater
Heater



Stop
Valve



Comfort
Height



Swivel
Stop



Forward
Rotating Lever



Easy
Dock



GROHE CONCETTO

Choose from a low, medium or high spout, with swivel spout extractable mousseur or extractable mousseur spray. Add to this the new pull-out dual spray function on the medium spout tap, and you can see that GROHE's Concetto range really has got all the options covered in a stylish, minimalist design.





● ● ●
31 128 001 / 31 128 DC1
 Sink mixer medium spout
 with pull-out mousseur



● ● ●
31 129 001 / 31 129 DC1
 Sink mixer medium spout
 with pull-out mousseur



● ● ● **NEW**
30 273 001 / 30 273 DC1
 Sink mixer medium spout
 with pull-out dual spray



● ● ●
32 659 001 / 32 659 DC1
 Sink mixer low spout

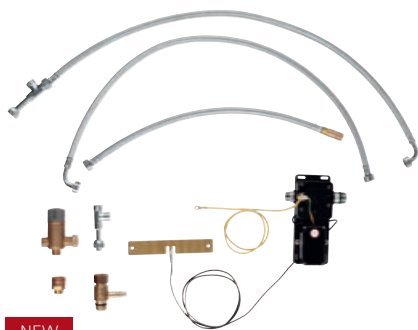

NEW
30 309 000
 Retro-Fit set
 for upgrading any GROHE pull-out kitchen
 tap with FootControl technology



● ● ●
40 535 000 / 40 535 DC0
 Cosmopolitan soap dispenser
 for liquid soaps
 storage bin 0.4 l

Colour options:

● 000/001 | StarLight Chrome | ● DC0/DC1 | SuperSteel



GROHE
SilkMove®



GROHE
StarLight®



Pull-Out
Dual Spray



Pull-Out
Mousseur



OpenWater
Heater



Stop
Valve



Pre
Window



Comfort
Height



Swivel
Stop



Easy
Dock



GROHE EUROSTYLE COSMOPOLITAN

Great design and great performance are at your fingertips with the Eurostyle Cosmopolitan range. From the appealing lozenge-shape of the lever to a choice of dynamic spout shapes, Eurostyle Cosmopolitan has a solution for every type of kitchen environment.





GROHE EUROSTYLE COSMOPOLITAN

Low, medium or high spout, a pull-out mousser or an extractable mousseur spray option, even a model perfect for installation below a kitchen window – the Eurostyle Cosmopolitan offers design options that you'll love with the great GROHE performance you'd expect.



33 975 002
Sink mixer high spout



33 977 002
Sink mixer low spout



31 126 002
Sink mixer high spout
with pull-out mousseur



NEW

31 482 002
Sink mixer high spout
with pull-out mousseur spray



30 221 002
Sink mixer high spout



31 124 002
Sink mixer medium spout



31 159 002
Sink mixer
pre-window



31 153 002
Sink mixer medium spout
with shut-off valve



33 982 002 + 18 383 002
Sink mixer
wall-mounted
with tray

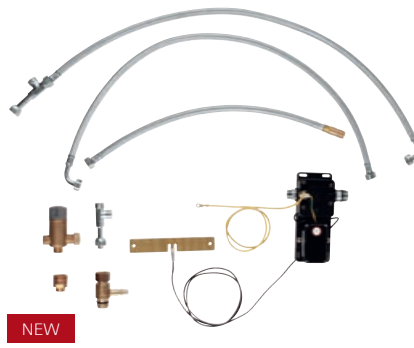

NEW

30 309 000
Retro-Fit set
for upgrading any GROHE pull-out kitchen
tap with FootControl technology



40 535 000
Cosmopolitan soap dispenser
for liquid soaps
storage bin 0.4 l



GROHE
SilkMove®



GROHE
StarLight®



Pull-Out
MousseurSpray



Pull-Out
Mousseur



OpenWater
Heater



Stop
Valve



Pre
Window



Comfort
Height



Swivel
Stop



Forward
Rotating Lever



Easy
Dock

GROHE EUROSMART COSMOPOLITAN

Simplicity is at the heart of good design and functionality. That's why GROHE's Eurosmart Cosmopolitan range focuses on the essentials to create a collection with durable details and architectural edge.





GROHE EUROSMART COSMOPOLITAN

Put ergonomics and architectural lines centre-stage in your kitchen with Eurosmart Cosmopolitan. This range simplicity doesn't mean lack of choice – from the three height options to the user-friendly swivel spout or an extractable mousseur spray you'll find a solution to suit you and your own contemporary kitchen.





32 843 000
Sink mixer high spout



31 481 000
Sink mixer high spout
with pull-out mousseur spray



30 193 000
Sink mixer medium spout



32 842 000
Sink mixer low spout



31 170 000
Sink mixer low spout



31 161 000
Sink mixer low spout

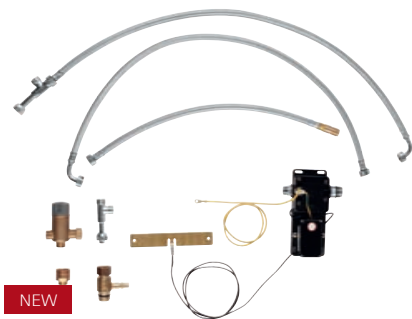

30 309 000
Retro-Fit set
for upgrading any GROHE pull-out kitchen
tap with FootControl technology



40 535 000 / 40 535 DC0
Cosmopolitan soap dispenser
for liquid soaps
storage bin 0.4 l

Colour options:

● 000 | StarLight Chrome | ● DC0 | SuperSteel



GROHE
EcoJoy



GROHE
SilkMove®



GROHE
StarLight®



Pull-Out
MousseurSpray



OpenWater
Heater



Stop
Valve



Pre
Window



Comfort
Height



Swivel
Stop



Easy
Dock



GROHE EUROSMART

Create a kitchen that the whole family can take pleasure in with the new GROHE Eurosmart. Effortless control, unrivalled performance and temperature-safe operation combine in a sleek contemporary design.





GROHE EUROSMART



MAKE THE SMART DESIGN CHOICE

Eurosmart has more features than ever before. The easy exchange mousseur lets you install or remove it to clean limescale with just a coin. Separate inner water ways guarantee that the water inside the tap never comes into contact with lead or nickel. You'll also find that our optional variant with GROHE SilkMove® ES cartridge supplies cold water only when the lever is in the central position, which saves energy because water is not heated unnecessarily. Add to that an integrated temperature limiter that can be individually set to your desired maximum temperature and you'll understand why Eurosmart puts unbeatable functionality in your hands.



Lead and nickel free: separated inner water ways
Isolated inner water ways guarantee water has no contact with lead or nickel



EasyExchange mousseur
The mousseur is easy to install and de-install using just a coin

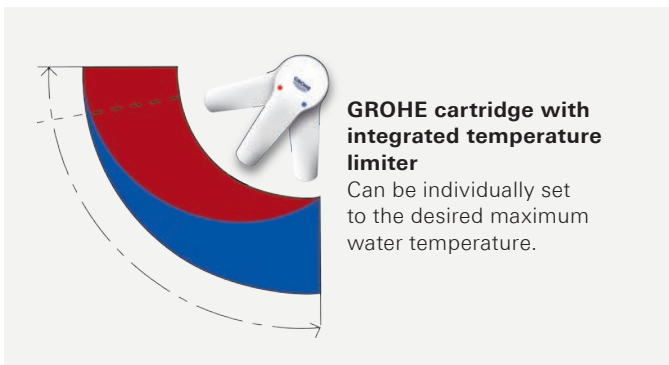

GROHE EUROSMART

The solid cylindrical body, the elegant curve of the spout – the new Eurosmart range looks great while offering huge versatility. In a variety of two heights, with a useful swivel spout and the option of our water-saving GROHE EcoJoy feature or the energy-saving cold-start cartridge GROHE SilkMove® ES, the new Eurosmart is bound to fit in with your busy family kitchen.





33 281 002
Sink mixer low spout
lead & nickel free



30 260 002
Sink mixer low spout
lead & nickel free
with GROHE SilkMove® ES



33 202 002
Sink mixer high spout



40 536 000 / 40 536 DC0
Contemporary soap dispenser
for liquid soaps
storage bin 0.4 l

Colour options:

● 000/002/20E | StarLight Chrome | ● DC0/DC2 | SuperSteel



GROHE EcoJoy



GROHE SilkMove®



GROHE SilkMove® ES



GROHE StarLight®



Lead+ Nicke Free



Easy exchange



Comfort Height



Swivel Stop



Stop Valve



GROHE BAU

Stunning simplicity defines the GROHE Bau. The cylindrical spout creates a lightness of design ideal for architectural schemes without compromising performance. The unique loop-shaped lever of BauLoop and the lozenge-shaped lever of BauEdge simplify handling and are extremely easy to operate.



31 367 000
GROHE BauEdge
Kitchen sink mixer



31 368 000
GROHE BauLoop
Kitchen sink mixer



40 536 000
Contemporary soap dispenser
for liquid soaps
storage bin 0.4 l



GROHE
SilkMove®



Comfort
Height





GROHE COSTA S

Can you improve on a classic? At GROHE that's just what we've done. The Costa collection was first launched in the 1970s, and we've been refining it ever since. It's design that has stood the test of time, improved and updated with the latest GROHE engineering excellence.



31 819 001
Sink mixer



40 536 000
Contemporary soap dispenser
for liquid soaps
storage bin 0.4 l



GROHE
SilkMove®



Comfort
Height





GROHE SOAP DISPENSERS

The perfect way to add the finishing touch to your kitchen is with one of GROHE's range of modern and elegant soap dispensers. Practical and durable, they are built with classic GROHE workmanship and designed to match all of GROHE's kitchen taps.





40 535 000 / 40 535 DC0
Cosmopolitan soap dispenser
for liquid soaps
storage bin 0.4 l



40 536 000 / 40 536 DC0
Contemporary soap dispenser
for liquid soaps
storage bin 0.4 l



40 537 000
Authentic soap dispenser
for liquid soaps
storage bin 0.4 l



40 553 000 / 40 553 DC0
Zedra soap dispenser
for liquid soaps
storage bin 0.4 l

Colour options:























● 000 | StarLight Chrome | ● DC0 | SuperSteel



















GROHE
StarLight®























GROHE FUNCTIONALITY AT A GLANCE

	DESIGN	EASYTOUCH	FOOTCONTROL	CAST SPOUT	TUBE SPOUT	PROFESSIONAL SPRAY	PULL-OUT DUAL SPRAY	PULL-OUT MOUSSEUR SPRAY	PULL-OUT MOUSSEUR	SIDE SPRAY	PRE-WINDOW	SHUT-OFF VALVE	CHROME	SUPERSTEEL	STAINLESS STEEL	SOAP DISPENSER 40 535 000 / 40 535 DC0	SOAP DISPENSER 40 536 000 / 40536 DC0	SOAP DISPENSER 40 553 000 / 40 553 DC0	SOAP DISPENSER 40 537 000 / 40 537 DC0
GROHE K7®				●			●			●			●	●		●			
						●							●	●		●			
GROHE ZEDRA TOUCH		●			●		●						●	●				●	
GROHE MINTA TOUCH		●			●			●					●	●		●			
		●			●				●				●	●		●			
GROHE K7 FOOTCONTROL			●			●							●	●		●			
GROHE ESSENCE FOOTCONTROL			●				●						●	●		●			
GROHE ZEDRA					●		●						●		●			●	
					●		●	●			●		●		●			●	
GROHE MINTA					●		●		●				●	●		●			
					●			●	●				●	●		●			
					●			●	●				●	●		●			
GROHE K4				●		●		●					●		●			●	
GROHE ESSENCE					●		●						●	●		●			
GROHE EUROCUBE				●									●	●					
						●							●	●					
GROHE AMBI					●								●			●	●		
GROHE PARKFIELD					●		●						●	●					●
GROHE EUROPLUS				●			●						●				●		
				●			●						●				●		
GROHE EURODISC COSMOPOLITAN				●			●		●		●	●	●			●			
				●					●				●			●			
					●								●			●			













GROHE FUNCTIONALITY AT A GLANCE

	DESIGN	EASYTOUCH	FOOTCONTROL	CAST SPOUT	TUBE SPOUT	PROFESSIONAL SPRAY	PULL-OUT DUAL SPRAY	PULL-OUT MOUSSEUR SPRAY	PULL-OUT MOUSSEUR	SIDE SPRAY	PRE-WINDOW	SHUT-OFF VALVE	CHROME	SUPERSTEEL	STAINLESS STEEL	SOAP DISPENSER 40 535 000 / 40 535 DC0	SOAP DISPENSER 40 536 000 / 40536 DC0	SOAP DISPENSER 40 553 000 / 40 553 DC0	SOAP DISPENSER 40 537 000 / 40 537 DC0
GROHE EURODISC				●			●						●				●		
					●								●				●		
GROHE CONCETTO				●									●	●		●			
				●			●	●			●	●	●	●		●			
					●								●			●			
GROHE EUROSTYLE COSMOPOLITAN				●									●			●			
				●							●	●	●			●			
					●			●	●				●			●			
GROHE EUROSMART COSMOPOLITAN					●						●	●	●			●			
					●							●	●	●		●			
					●			●					●	●		●			
GROHE EUROSMART				●									●	●			●		
					●							●	●	●			●		
					●								●				●		
GROHE BAU				●								●				●			
GROHE COSTA S					●								●			●			

GROHE BLUE® & GROHE RED® WATER SYSTEMS

	DESIGN	MIXED WATER	FILTERED WATER	SPARKLING WATER	BOILING WATER	CAST SPOUT	TUBE SPOUT	SIDE SPRAY	CO2-BOTTLE 425 G	FILTER 600 LITRE	FILTERHEAD	BOILER	CHROME	SUPERSTEEL	STAINLESS STEEL	SOAP DISPENSER 40 535 000 / 40 535 DC0	SOAP DISPENSER 40 553 000 / 40 553 DC0
GROHE BLUE®		●	●	●			●		●	●	●		●	●		●	
		●	●	●			●		●	●	●		●	●		●	
GROHE BLUE® MINTA		●	●	●			●		●	●	●		●	●		●	
		●	●	●		●		●	●	●	●		●	●		●	
GROHE BLUE® K7		●	●	●		●			●	●	●		●	●		●	
		●	●	●		●		●	●	●	●		●	●		●	
GROHE BLUE® MONO			●	●			●		●	●	●		●	●		●	
		●	●				●			●	●		●	●		●	
GROHE BLUE® PURE		●	●				●			●	●		●	●		●	
		●	●				●			●	●		●	●		●	
GROHE BLUE® MINTA PURE		●	●				●			●	●		●	●		●	
		●	●			●		●		●	●		●	●		●	
GROHE BLUE® K7 PURE		●	●			●				●	●		●	●		●	
		●	●			●		●		●	●		●	●		●	
GROHE BLUE® MONO PURE			●				●			●	●		●	●		●	
		●			●		●					●	●	●		●	
GROHE RED® DUO		●			●		●					●	●	●		●	
		●			●		●					●	●	●		●	
GROHE RED® MONO					●		●					●	●	●		●	
					●		●					●	●	●		●	

GROHE LOW PRESSURE FITTINGS

	DESIGN	EASYTOUCH	FOOTCONTROL	CAST SPOUT	TUBE SPOUT	PROFESSIONAL SPRAY	PULL-OUT DUAL SPRAY	PULL-OUT MOUSSEUR SPRAY	PULL-OUT MOUSSEUR	SIDE SPRAY	PRE-WINDOW	SHUT-OFF VALVE	CHROME	SUPERSTEEL	STAINLESS STEEL	SOAP DISPENSER 40 535 000 / 40 535 DC0	SOAP DISPENSER 40 536 000 / 40536 DC0	SOAP DISPENSER 40 553 000 / 40 553 DC0	SOAP DISPENSER 40 537 000 / 40 537 DC0
GROHE ZEDRA					●		●						●					●	
GROHE MINTA					●				●				●			●			
					●								●			●			
GROHE EUROPLUS				●									●				●		
GROHE EURODISC COSMOPOLITAN				●			●					●	●			●			
					●				●				●			●			
GROHE CONCETTO				●					●		●	●	●			●			
					●				●				●			●			
GROHE EUROSTYLE COSMOPOLITAN				●									●			●			
				●									●			●			
GROHE EUROSMART COSMOPOLITAN				●									●			●			
				●									●	●		●			
					●								●			●			

Grohe Limited
World Business Centre 2
Newall Road | London Heathrow Airport
Hounslow | Middlesex | TW6 2SF
Tel: 0871 200 3414
Fax: 0871 200 3415



© 06/2015 – Copyright by GROHE

FOR FURTHER INFORMATION
PLEASE VISIT OUR WEBSITE
WWW.GROHE.CO.UK



Follow us



PART OF **LIXIL**