



NOT185  
02.21

# Sanifloor+ 4 wedi®



**FR** NOTICE D'INSTALLATION

**UK** INSTALLATION INSTRUCTIONS

**DE** INSTALLATIONSHINWEISE

**IT** STRUZIONI PER L'INSTALLAZIONE

**ES** MANUAL DE INSTALACIÓN

**PT** MANUAL DE INSTALAÇÃO

**NL** INSTALLATIE VOORSCHRIFTEN

**SE** INSTALLATIONSANVISNING

**DK** INSTALLATIONSVEJLEDNING

**NO** INSTALLASJONSANVISNING

**FI** ASENNUSOHJEET

**HU** FELSZERELÉSI ÉS KEZELÉSI ÚTMUTATÓ

**PL** INSTRUKCJA INSTALACJI

**RU** ИНСТРУКЦИЯ ПО МОНТАЖУ И ЭКСПЛУАТАЦИИ

**RO** MANUAL DE INSTALARE

**CZ** NÁVOD K INSTALACI A POUŽÍVÁNÍ

**TR** KURULUM KILAVUZU

**EL** ΟΔΗΓΙΕΣ ΕΓΚΑΤΑΣΤΑΣΗΣ

**CN** 用户应保留安装指南以备用

**KR** 설치내용서

**HR** UPUTA ZA INSTALACIJU

**AR** بيكرتلا قرط





**UNIDOMO®**

**Web:** [www.unidomo.de](http://www.unidomo.de)

**Telefon:** 04621- 30 60 89 0

**Mail:** [info@unidomo.com](mailto:info@unidomo.com)

**Öffnungszeiten:** Mo.-Fr. 8:00-17:00 Uhr

**VIESMANN**

**Buderus**

 **Vaillant**

**WOLF**

 **JUNKERS**  **BOSCH**

 **remeha**

 **DAIKIN**

**ROTEX**

a member of DAIKIN group



-  Individuelle Beratung
-  Kostenloser Versand
-  Hochwertige Produkte

-  Komplettpakete
-  Über 15 Jahre Erfahrung
-  Markenhersteller

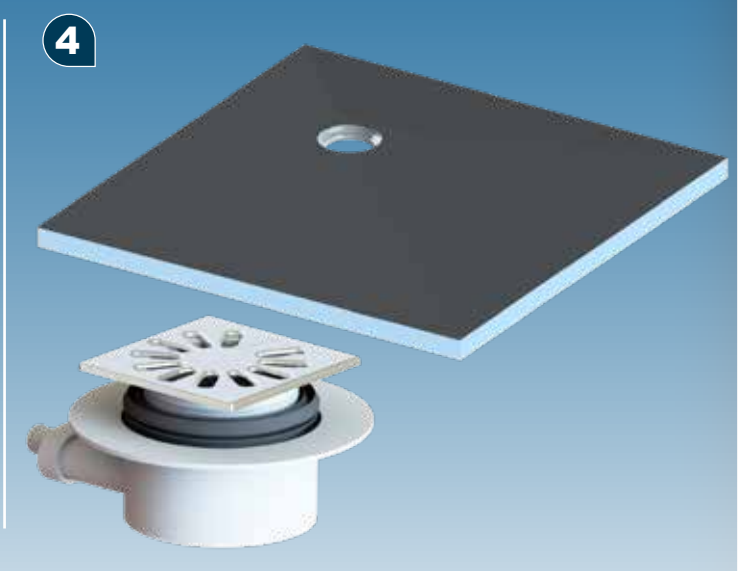
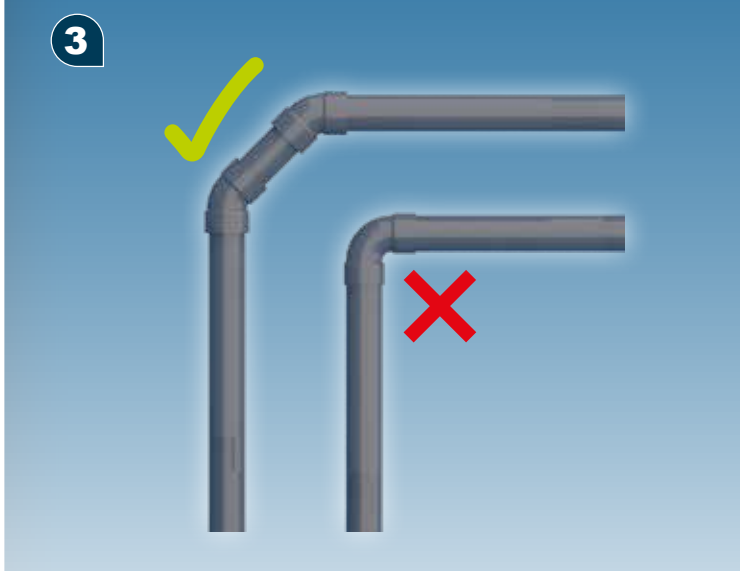
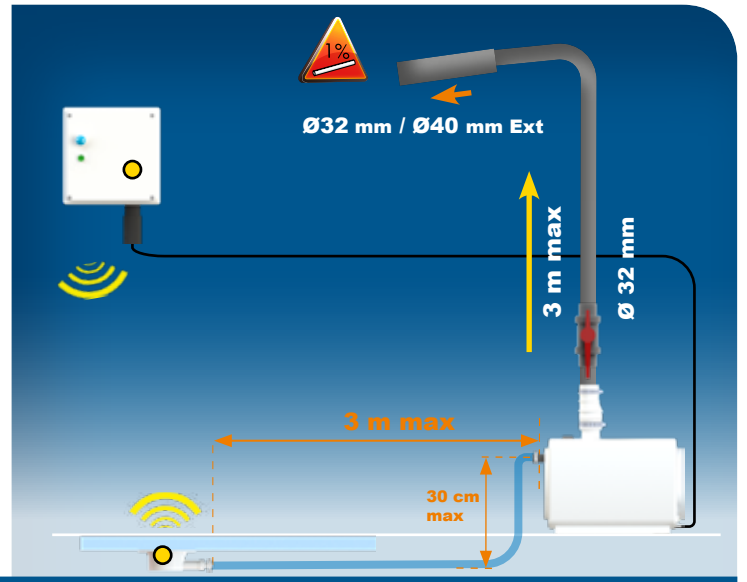
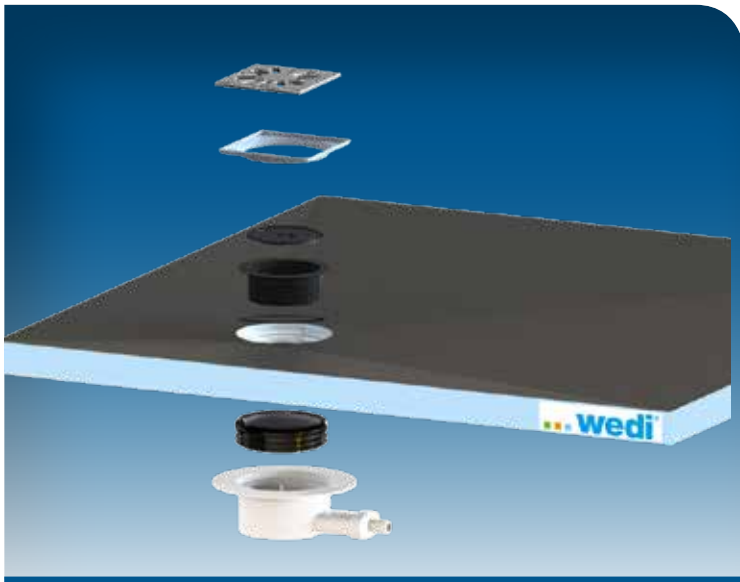

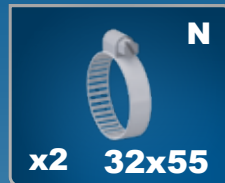
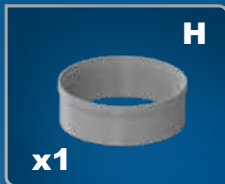
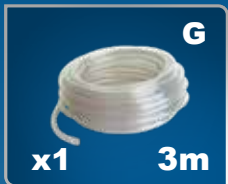
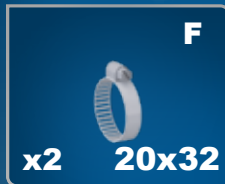
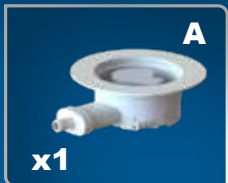

1

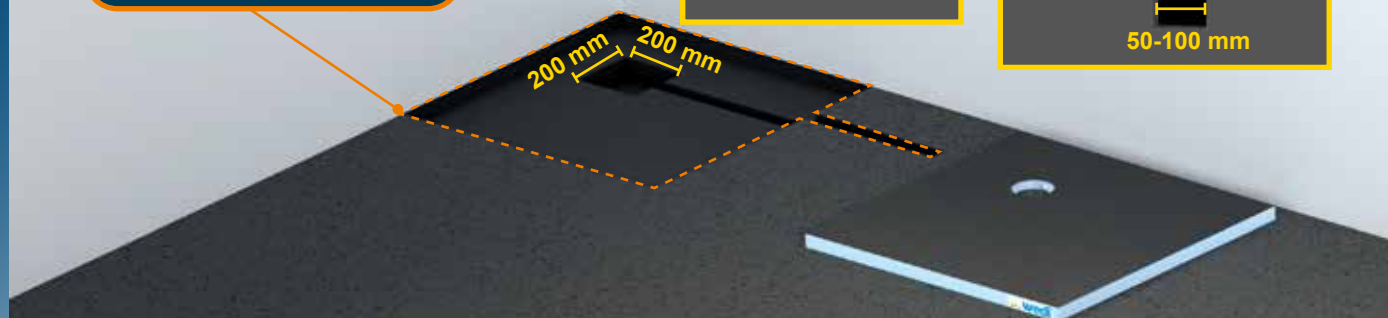
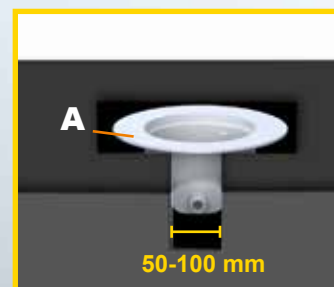

2

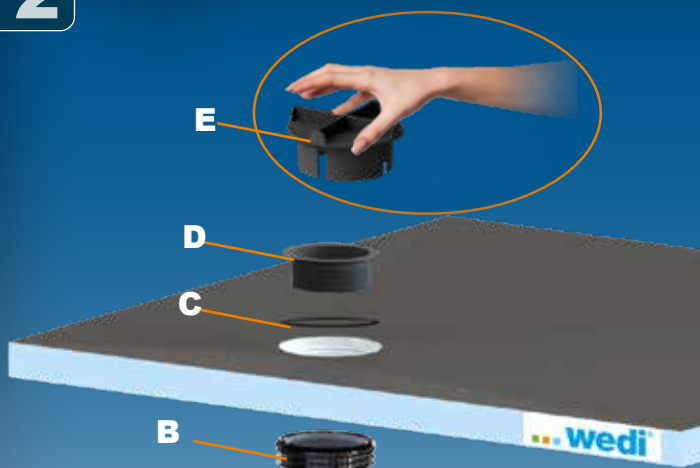

3

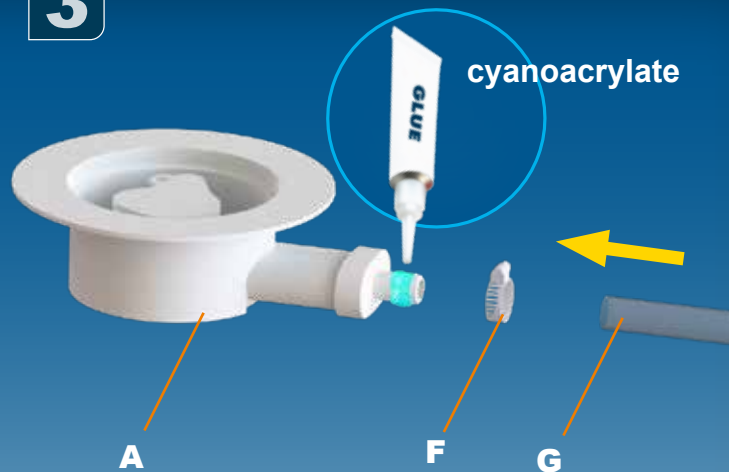

4



5



6

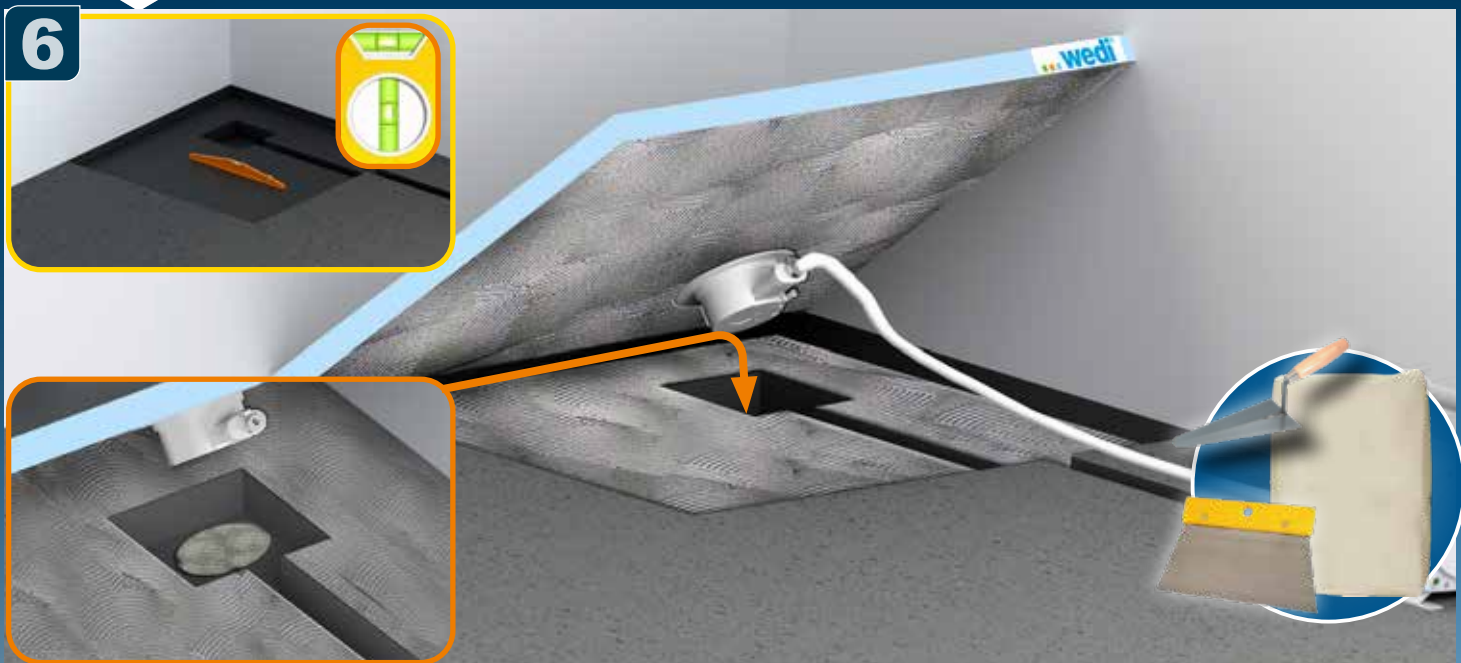

7



8



9



10

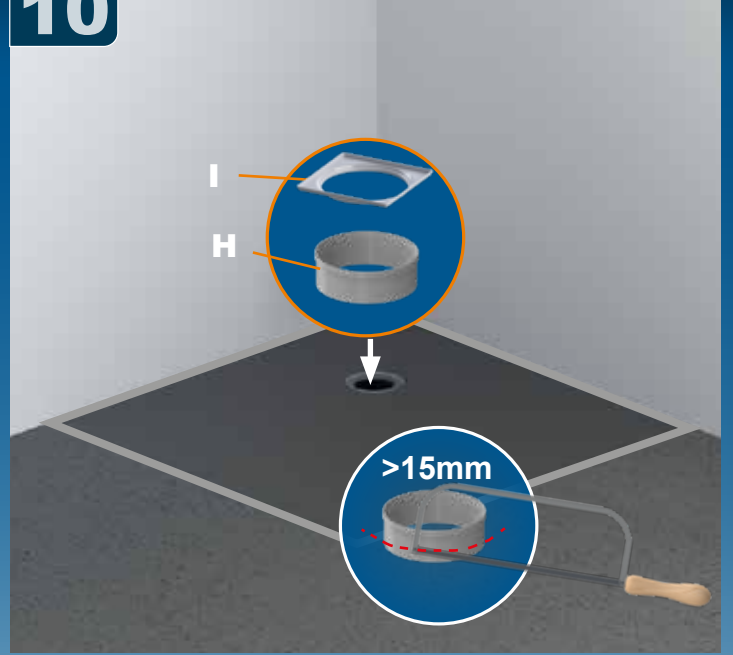

11

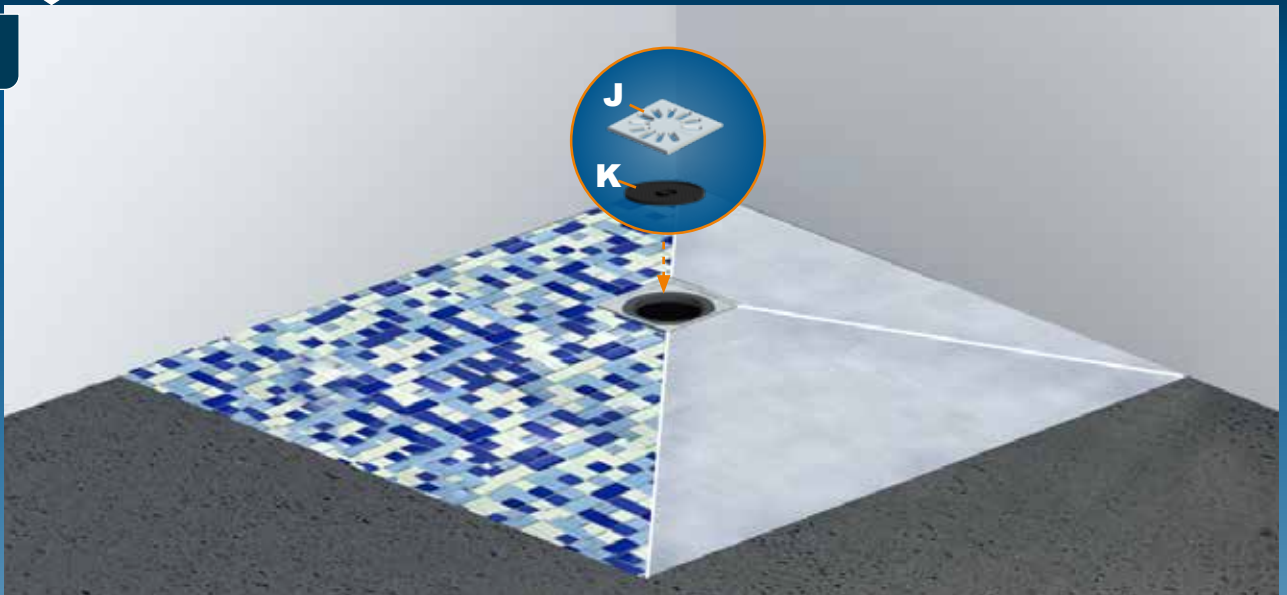

12

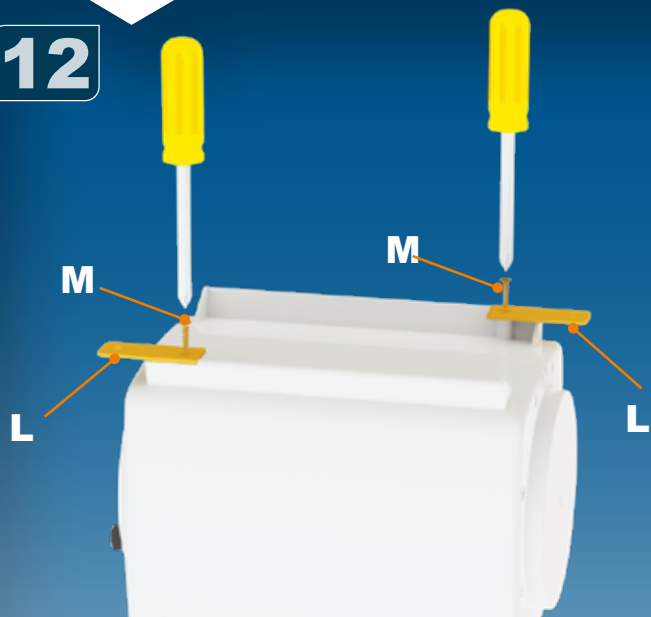

13



14

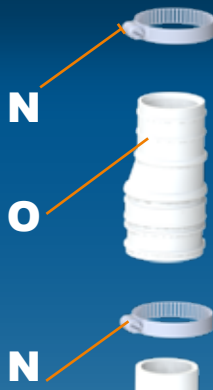

Ø 32 mm Ext

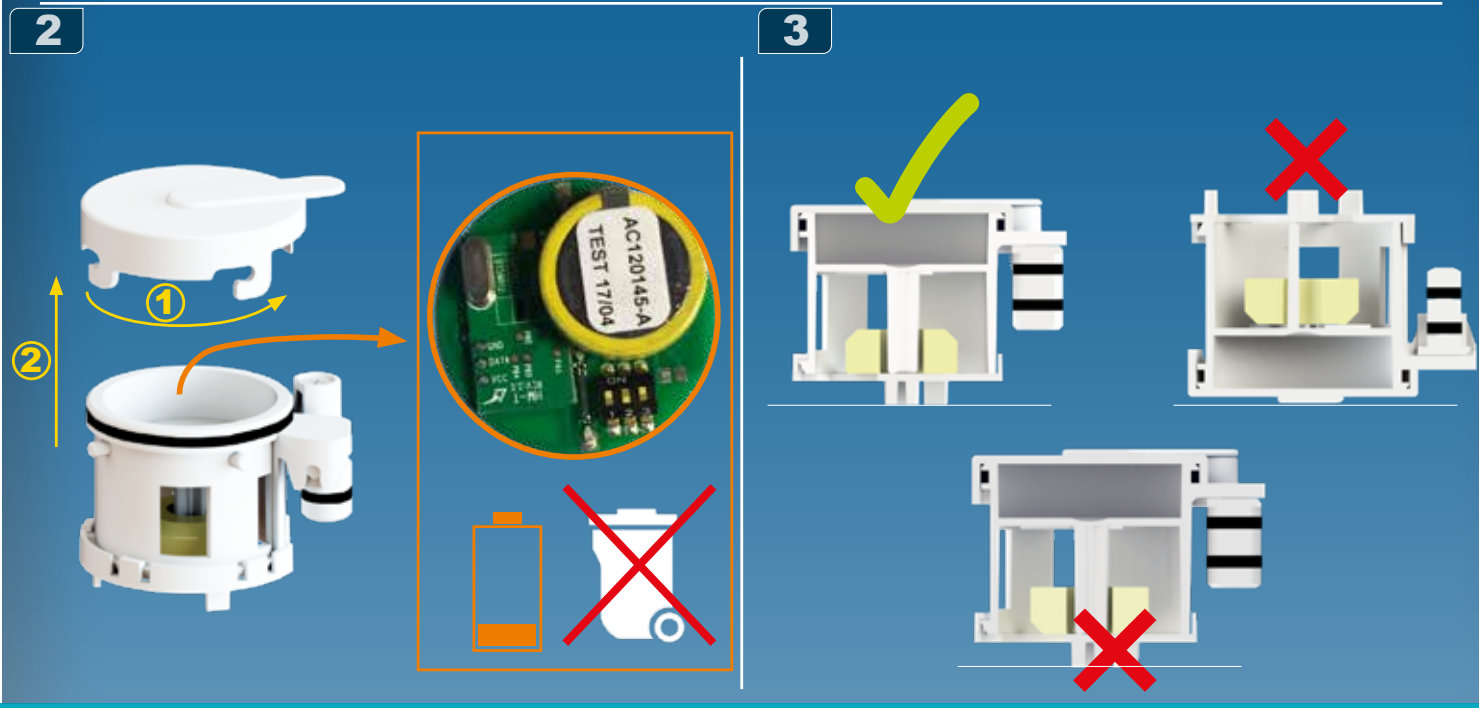
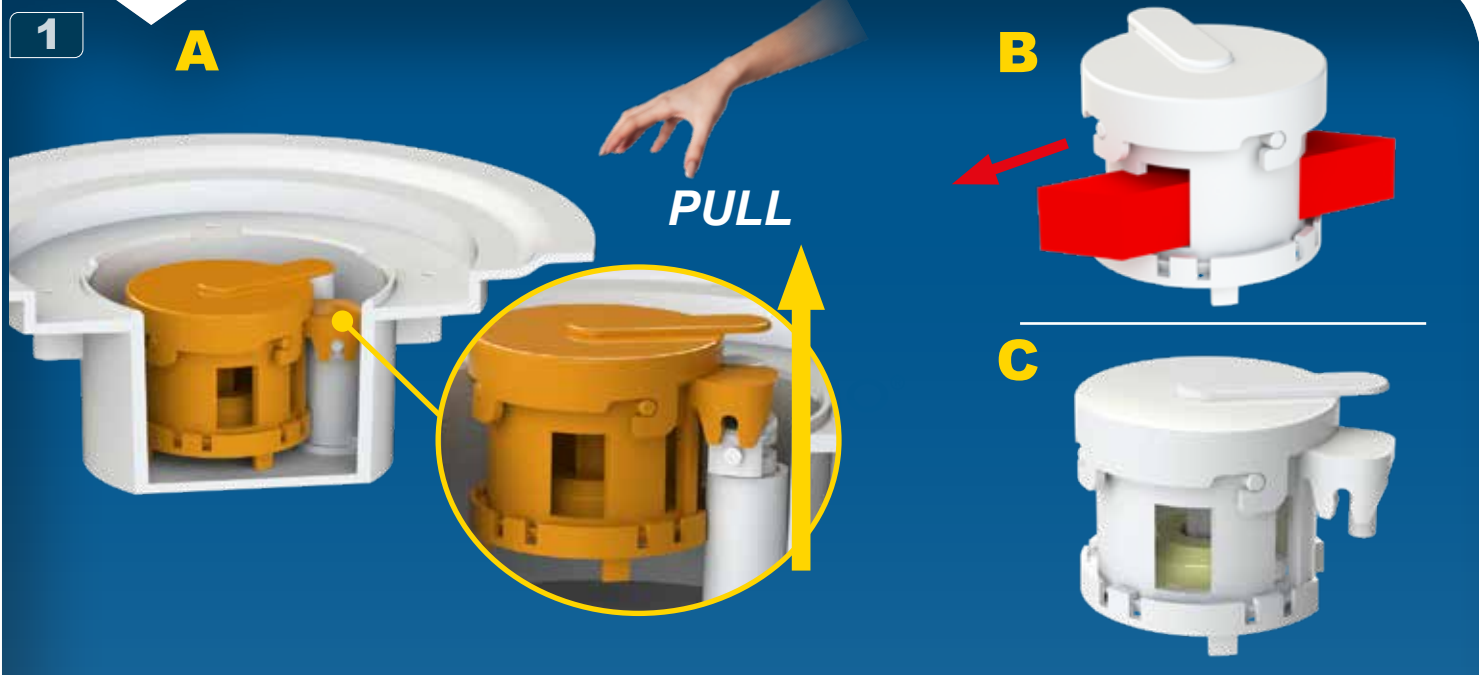





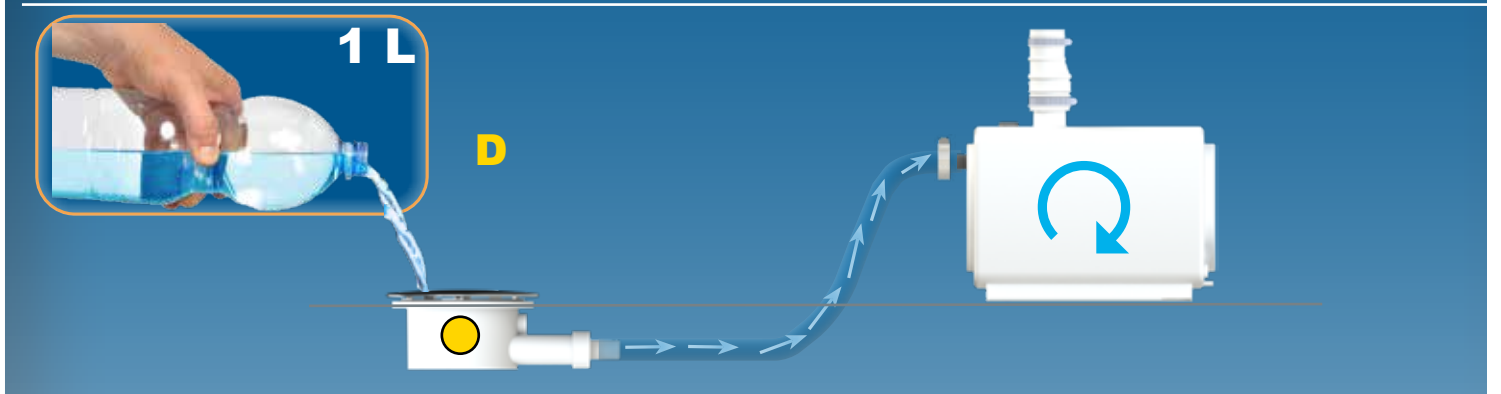
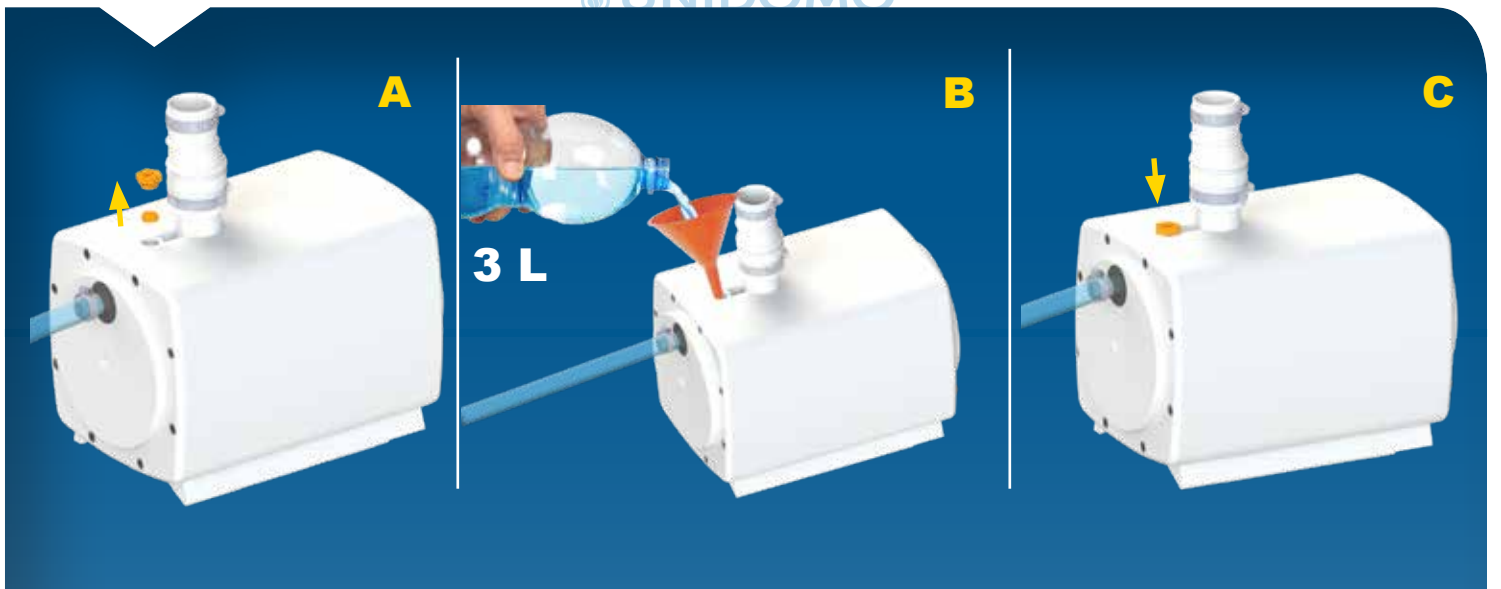
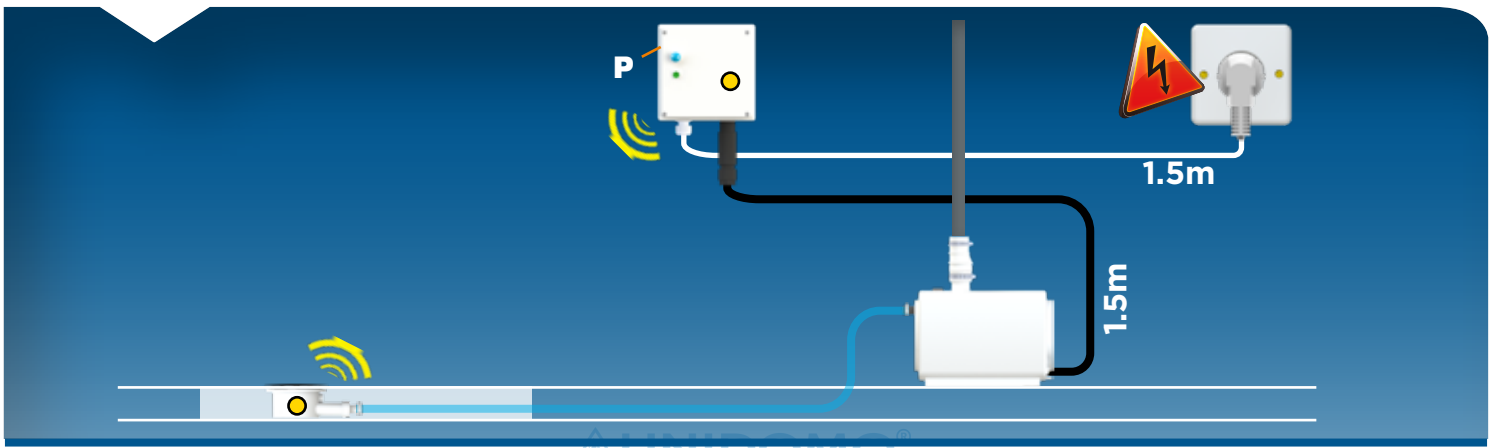
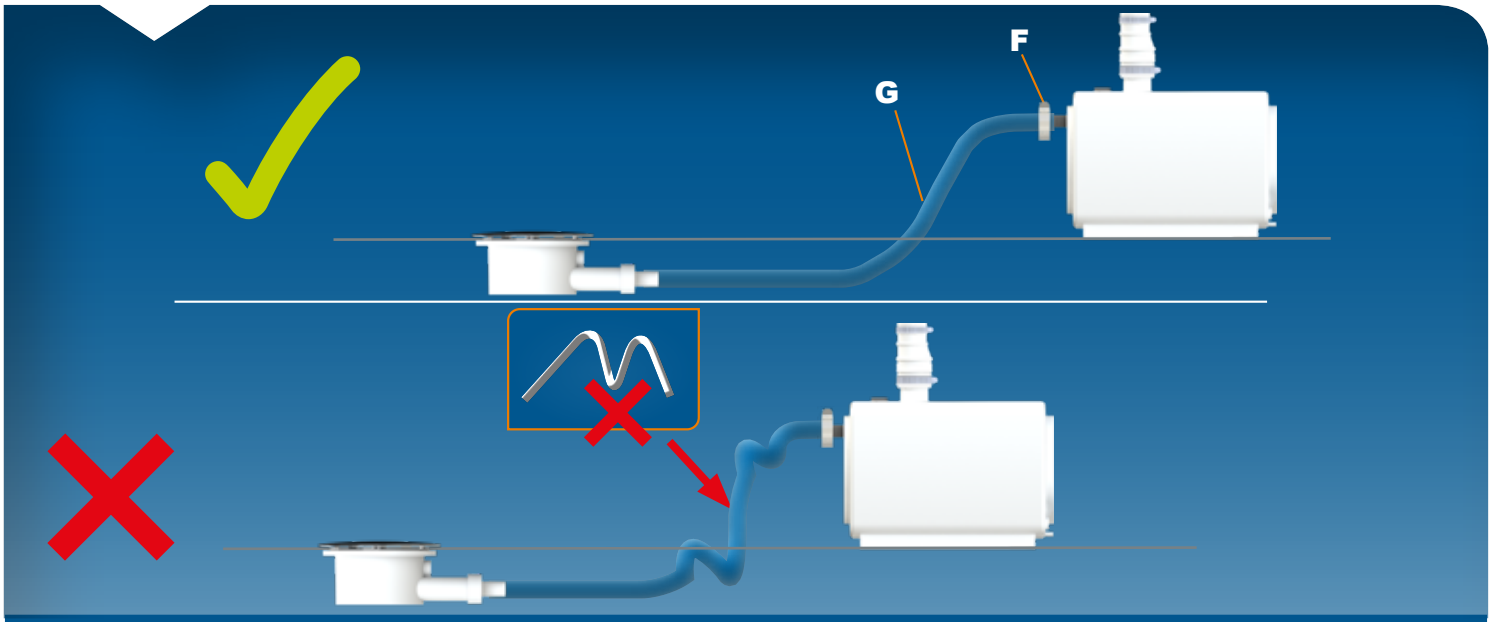

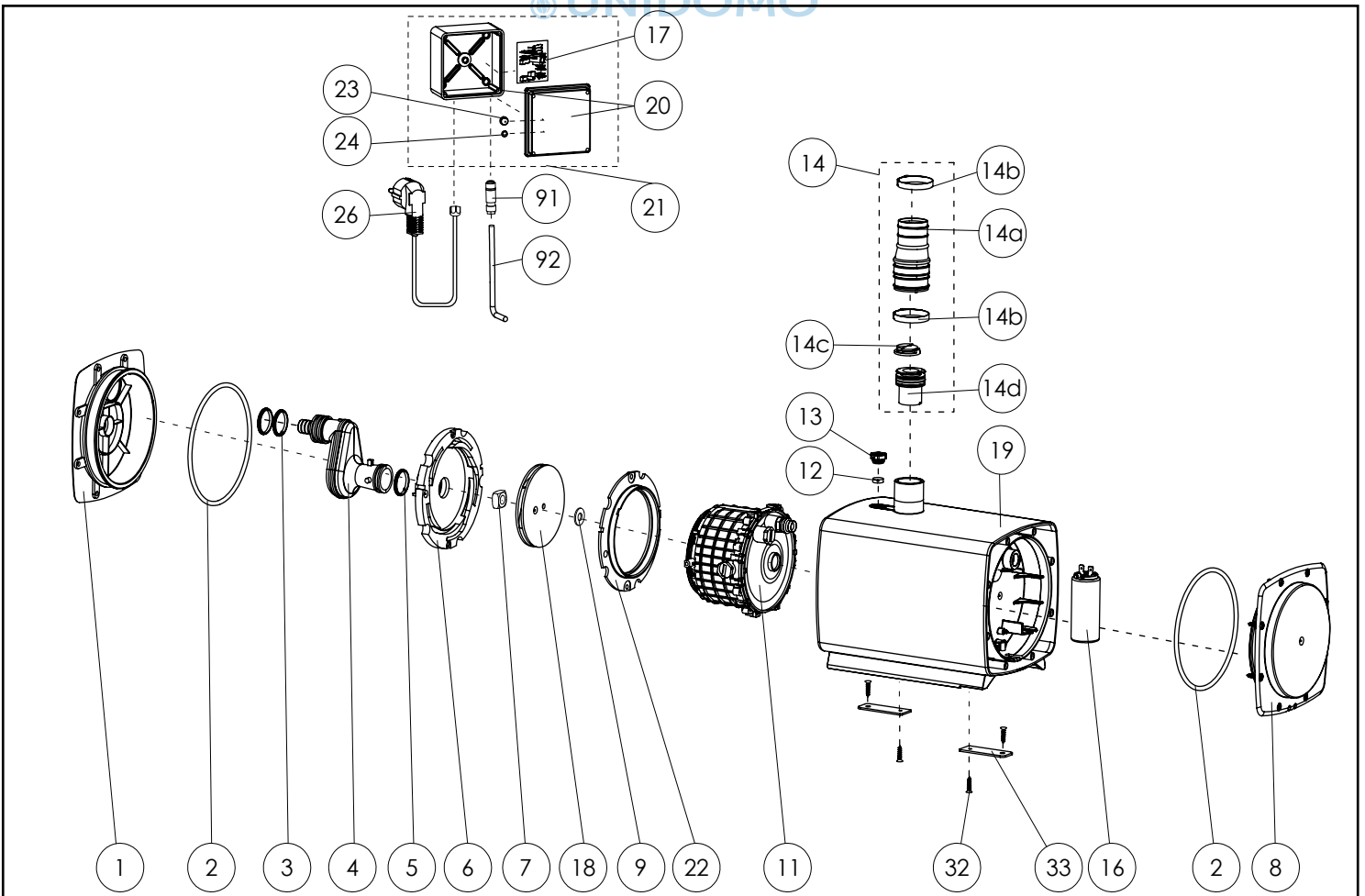
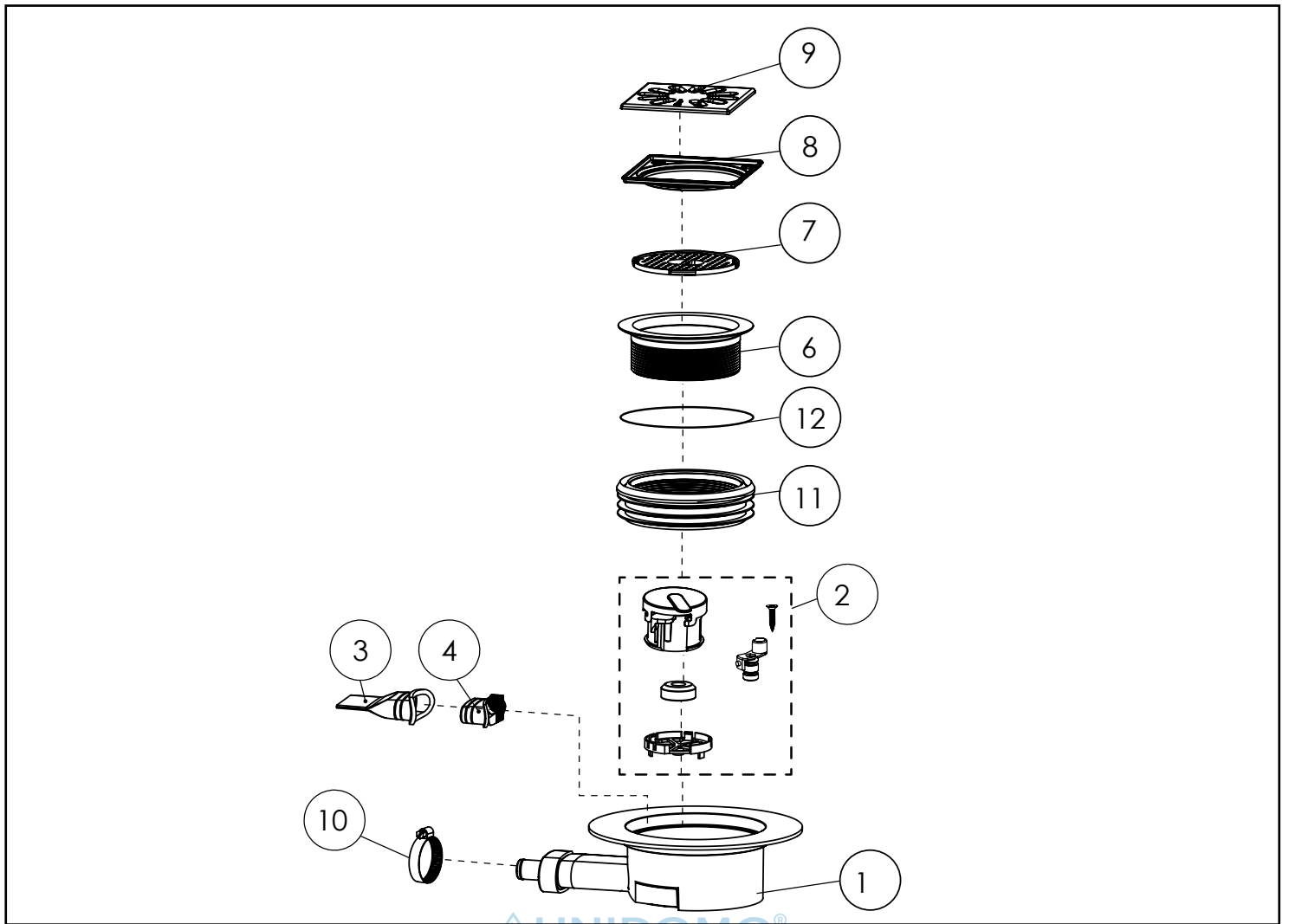



**UNIDOMO®**

**Web:** [www.unidomo.de](http://www.unidomo.de)

**Telefon:** 04621- 30 60 89 0

**Mail:** [info@unidomo.com](mailto:info@unidomo.com)

**Öffnungszeiten:** Mo.-Fr. 8:00-17:00 Uhr

**VIESMANN**

**Buderus**

 **Vaillant**

**WOLF**

 **JUNKERS**  **BOSCH**



 **remeha**



 **DAIKIN**

**ROTEX**

a member of DAIKIN group



-  Individuelle Beratung
-  Kostenloser Versand
-  Hochwertige Produkte

-  Komplettpakete
-  Über 15 Jahre Erfahrung
-  Markenhersteller

H

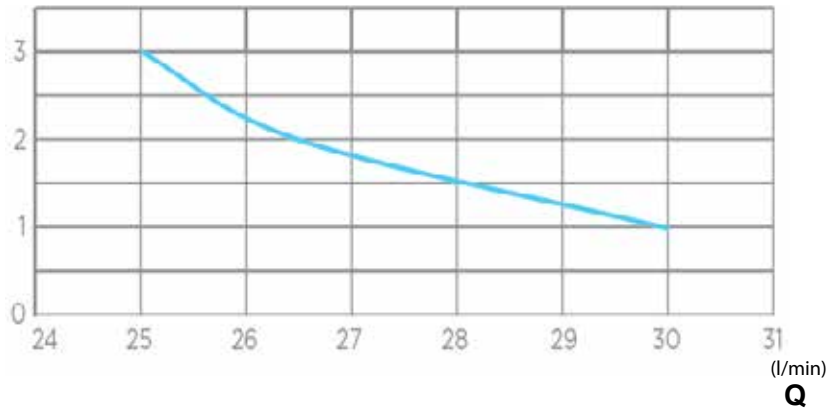

**SANIFLOOR+ 4 wedi**  
 220-240V - 50-60Hz - 400 W  
 IP44 - 1,7A - ⚡ Classe 1

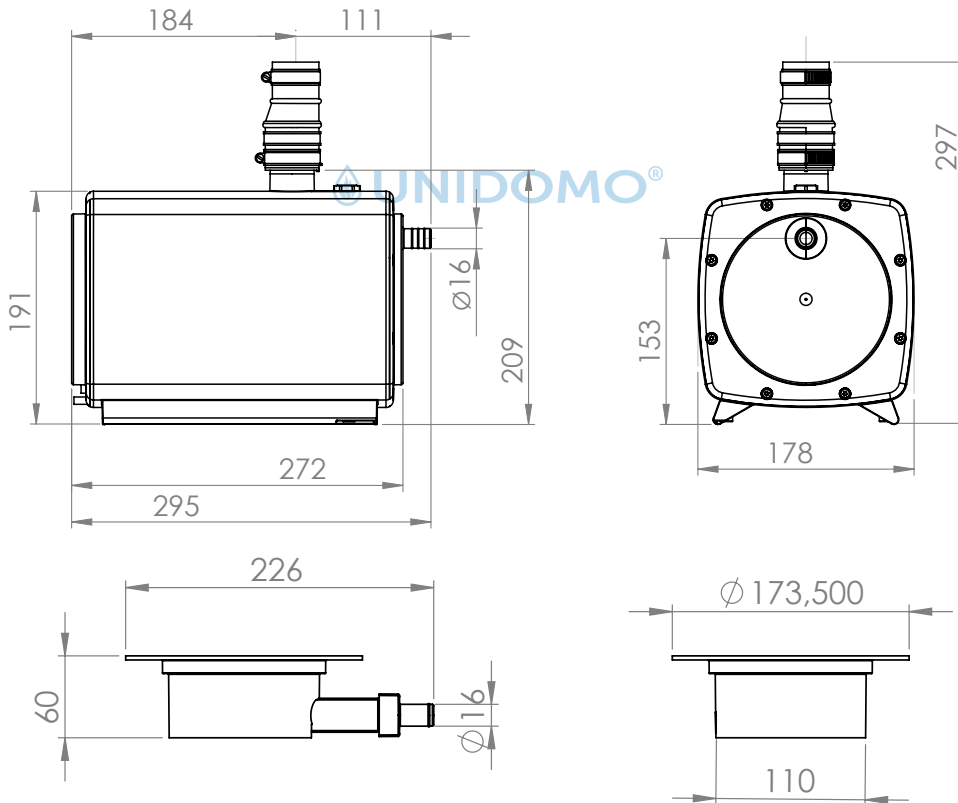
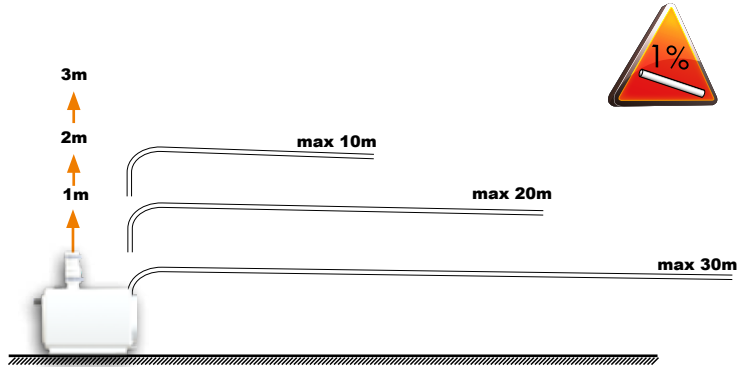

**SERVICE HELPLINES**

France  
 Tel. 01 44 82 25 55  
 Fax. 03 44 94 46 19

United Kingdom  
 Tel. 08457 650011 (Call from a land line)  
 Fax. 020 8842 1671

Ireland  
 Tel. 1850 23 24 25 (LOW CALL)  
 Fax. +353 46 97 33 093

Australia  
 Tel. +1300 554 779  
 Fax. +61.2.9882.6950

Deutschland  
 Tel. 0800 82 27 82 0  
 Fax. (060 74) 30928-90

Italia  
 Tel. 0382 6181  
 Fax. +39 0382 618200

España  
 Tel. +34 93 544 60 76  
 Fax. +34 93 462 18 96

Portugal  
 Tel. +35 21 911 27 85  
 Fax. +35 21 957 70 00

Suisse Schweiz Svizzera  
 Tel. +41 (0)32 631 04 74  
 Fax. +41 (0)32 631 04 75

Benelux  
 Tel. +31 475 487100  
 Fax. +31 475 486515

Sverige  
 Tel. +08-404 15 30

Norge  
 Tel. +08-404 15 30

Polska  
 Tel. (+4822) 732 00 33  
 Fax. (+4822) 751 35 16

РОССИЯ  
 Tel. (495) 258 29 51  
 Fax. (495) 258 29 51

Česká Republika  
 Tel. +420 266 712 855  
 Fax. +420 266 712 856

România  
 Tel. +40 724 364 543  
 service@saniflo.ro

Türkiye  
 Tel. +90 212 275 30 88  
 Fax. +90 212 275 90 58

Brazil  
 Tel. (11) 3052-2292

中國  
 Tel. +86(0)21 6218 8969  
 Fax. +86(0)21 6218 8970

South Africa  
 Tel. +27 (0) 21 286 00 28

Service information : [www.sfa.biz](http://www.sfa.biz)