

- (D) Montage- und Bedienanleitung
- (CN) 安装及操作指南
- (CZ) Návod k instalaci a k použití
- (E) Instrucciones de montaje y de manejo
- (F) Instructions de montage et mode d'emploi
- (GB) Installation and operating instructions
- (GR) ΟΔΗΓΙΕΣ ΕΓΚΑΤΑΣΤΑΣΗΣ ΚΑΙ ΣΥΝΤΗΡΗΣΗΣ
- (H) Szerelési és használati utasítás
- (I) Istruzioni di montaggio e per l'uso
- (NL) Montagehandleiding en Gebruiksaanwijzing
- (PL) Instrukcja montażu i obsługi
- (RO) Instrucțiuni de montaj și utilizare
- (RU) Руководство по монтажу и эксплуатации
- (SK) Návod na montáž a obsluhu

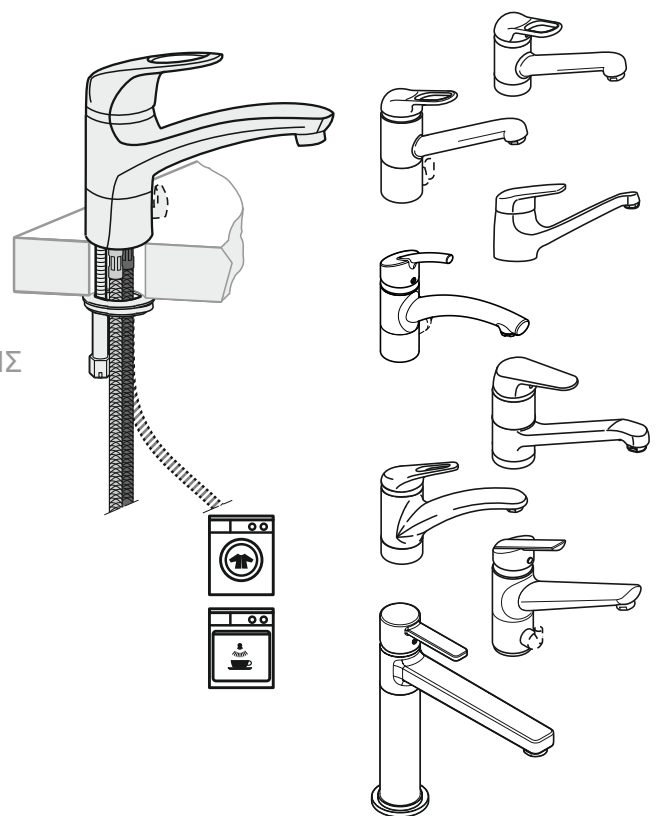



**UNIDOMO®**

**Web:** [www.unidomo.de](http://www.unidomo.de)

**Telefon:** 04621- 30 60 89 0

**Mail:** [info@unidomo.com](mailto:info@unidomo.com)

**Öffnungszeiten:** Mo.-Fr. 8:00-17:00 Uhr

**VIESMANN**

**Buderus**

 **Vaillant**

**WOLF**

 **JUNKERS**  **BOSCH**



 **remeha**



 **DAIKIN**

**ROTEX**

a member of DAIKIN group



-  Individuelle Beratung
-  Kostenloser Versand
-  Hochwertige Produkte

-  Komplettpakete
-  Über 15 Jahre Erfahrung
-  Markenhersteller

