

DUSCHPLAN

- ein Klassiker unter den Duschwannen
- modernes, klares Design mit nur 65 mm Tiefe
- in rechteckiger oder quadratischer Ausführung erhältlich
- aus KALDEWEI Stahl-Emaile
- Ablaufdeckel nahezu bündig in die Duschkante integriert (nur in Kombination mit den Ablaufgarnituren KA 90)

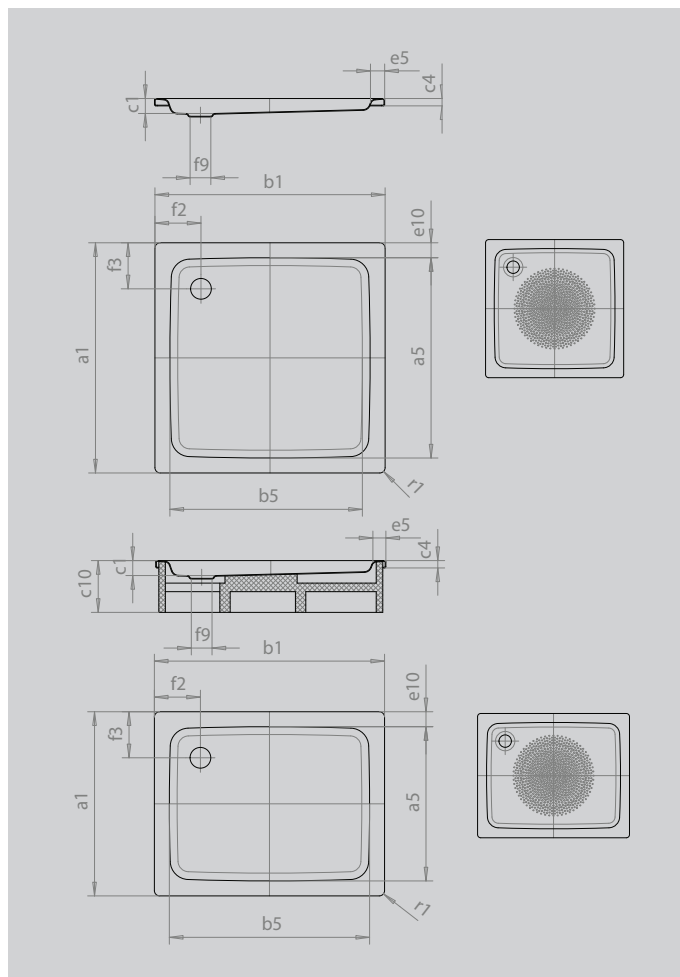

Abbildung ähnlich



 UNIDOMO®

Modell			418
Äußere Länge	a ₁		900 mm
Innere Länge	a ₅		770 mm
Äußere Breite	b ₁		1000 mm
Innere Breite	b ₅		870 mm
Tiefe Innen	c ₁		65 mm
Randhöhe	c ₄		32 mm
Höhe mit Wannenträger	c ₁₀		160 mm
Höhe mit Wannenträger extraflach	c ₁₆		49 mm
Randbreite	e ₅		65 mm
Abstand Wannrand bis Mitte Ablaufloch	f ₂		200 mm
Durchmesser Ablaufloch	f ₉		Ø 90 mm
Äußerer Radius	r ₁		12 mm
Nettogewicht			27 kg
Antislip Durchmesser			Ø 588 mm

KALDEWEI



UNIDOMO®

Web: www.unidomo.de

Telefon: 04621- 30 60 89 0

Mail: info@unidomo.com

Öffnungszeiten: Mo.-Fr. 8:00-17:00 Uhr

VIESMANN

Buderus

 **Vaillant**

WOLF

 **JUNKERS**  **BOSCH**



 **remeha**



 **DAIKIN**

ROTEX

a member of DAIKIN group



-  Individuelle Beratung
-  Kostenloser Versand
-  Hochwertige Produkte

-  Komplettpakete
-  Über 15 Jahre Erfahrung
-  Markenhersteller