



Ihr Online-Fachhändler für:



- Kostenlose und individuelle Beratung
- Hochwertige Produkte
- Kostenloser und schneller Versand

- TOP Bewertungen
- Exzelerter Kundenservice
- Über 20 Jahre Erfahrung



E-Mail: info@unidomo.de | Tel.: 04621 - 30 60 89 0 | www.unidomo.de

Einbauanleitung (Fliesenleger)
Mounting instruction (Tiler)
Montagehandleiding (Tegelzetter)
Instructions de montage (Carreleur)
Istruzioni di montaggio (Piastrellista)

Poresta® Slot

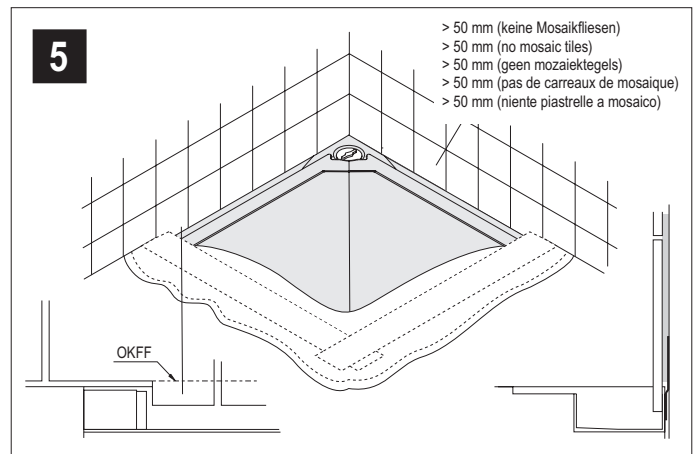
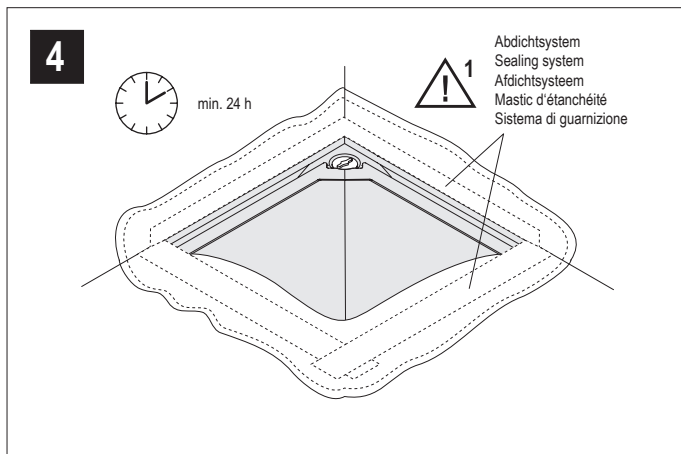
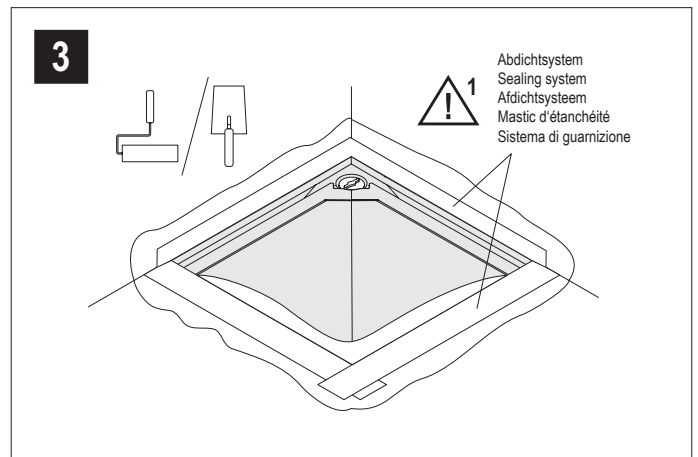
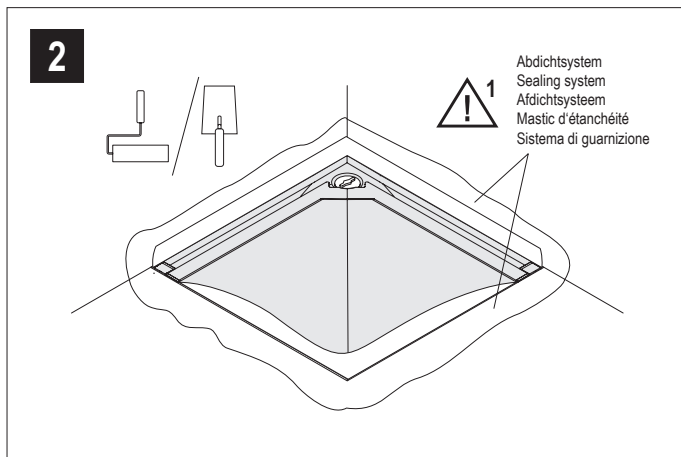
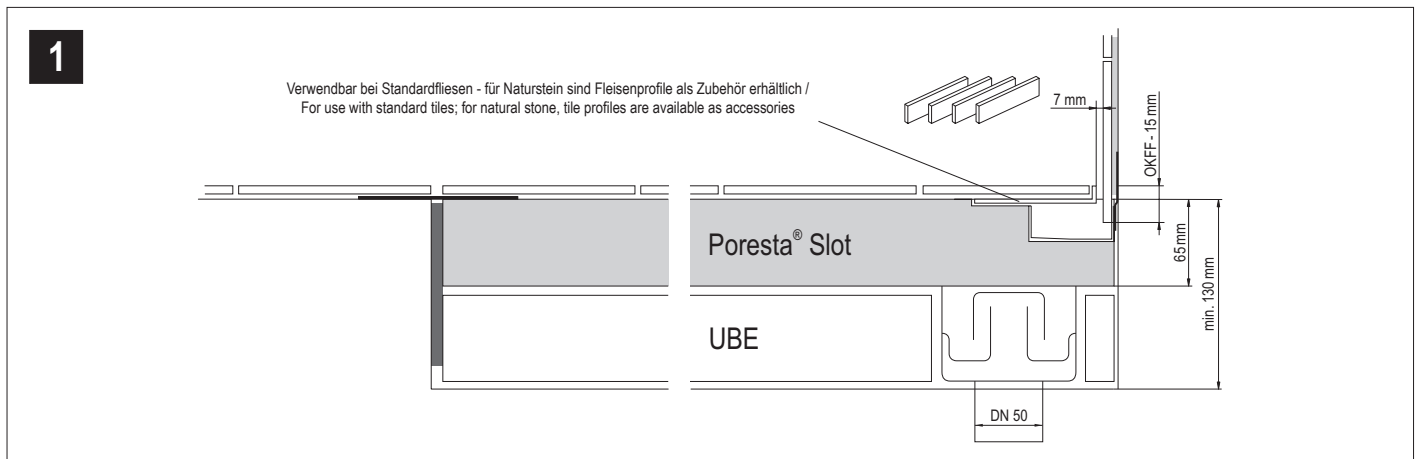

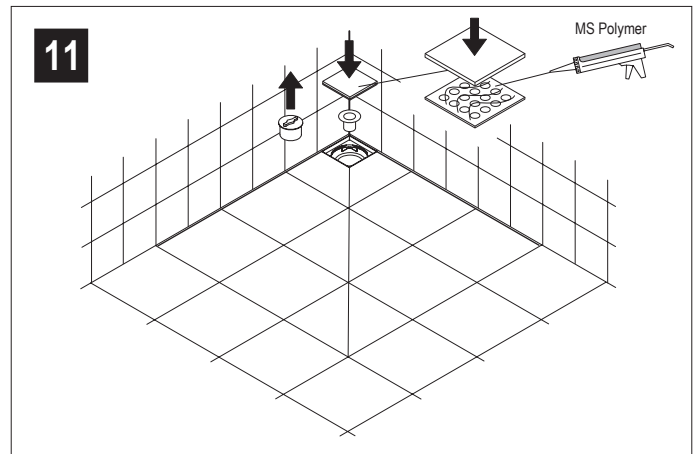
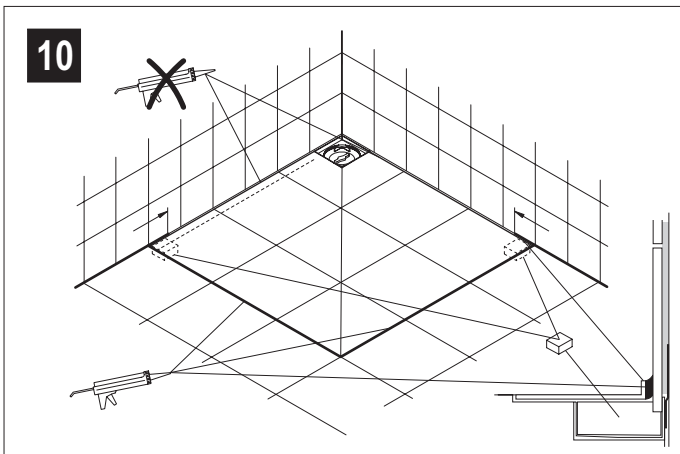
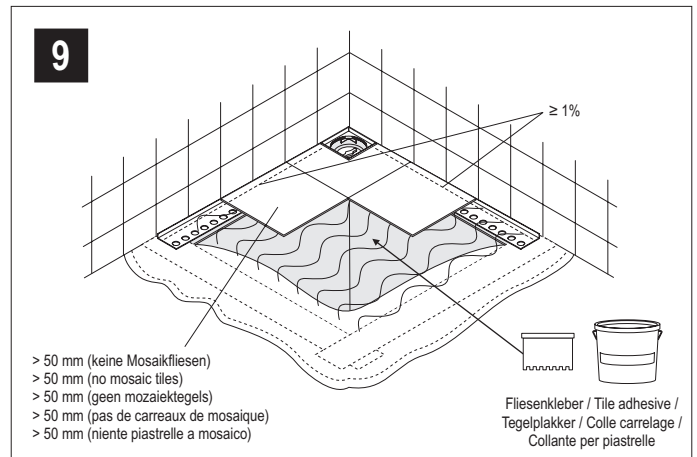
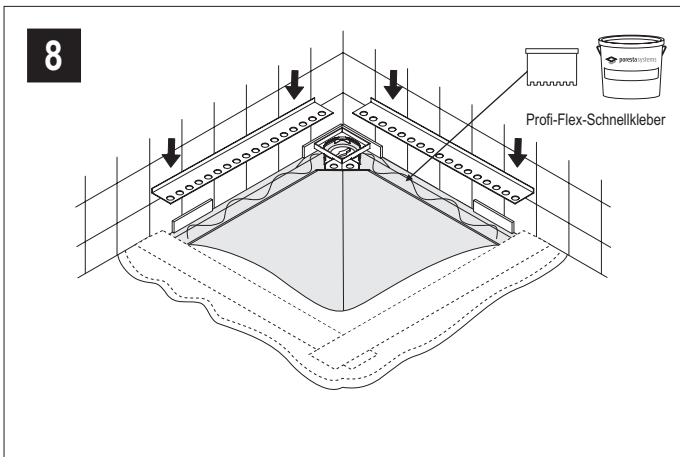
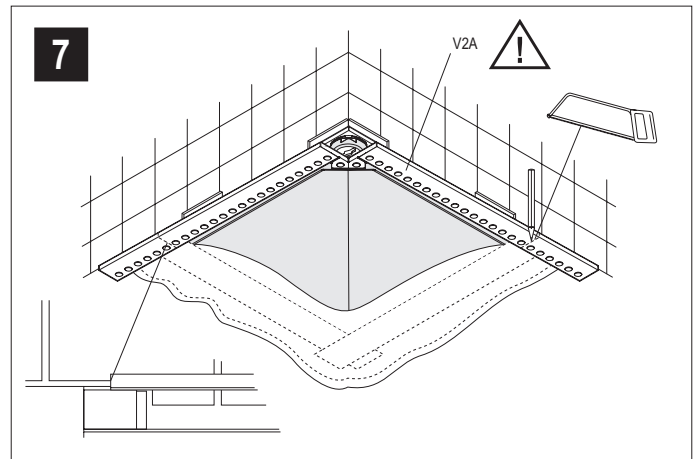
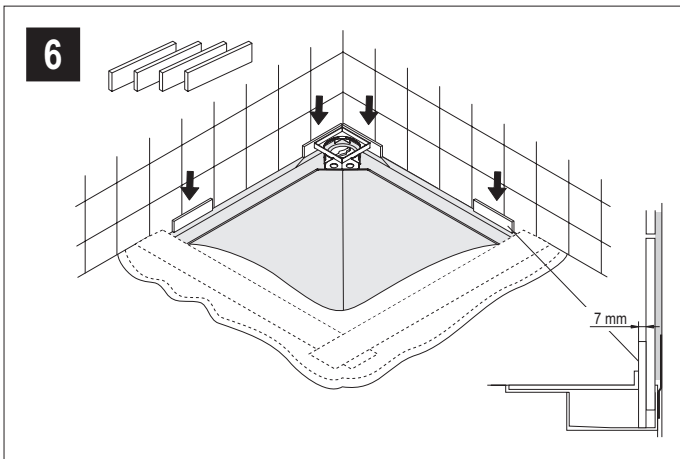

Einbauanleitung (Fliesenleger)
 Mounting instruction (Tiler)
 Montagehandleiding (Tegelzetter)
 Instructions de montage (Carreleur)
 Istruzioni di montaggio (Piastrellista)





Einbauanleitung (Fliesenleger)
Mounting instruction (Tiler)
Montagehandleiding (Tegelzetter)
Instructions de montage (Carreleur)
Istruzioni di montaggio (Piastrellista)

 Die einschlägigen Verarbeitungsrichtlinien aller beteiligten Gewerke sind zu berücksichtigen.

 Die Verarbeitungshinweise des Abdichtsystems sind zu beachten.

 The relevant processing guidelines of all trades involved must be observed.

 The processing guidelines for the sealing system must be observed.

 Met de betreffende toepassingsrichtlijnen van alle betroffen onderdelen moet rekening worden gehouden.

 Met de betreffende toepassingsrichtlijnen van afdichtstelsysteem moet rekening worden gehouden.

 Les directives correspondantes de mise en oeuvre de tous les métiers participants sont à observer.

 Observer les instructions de mise en oeuvre pour le système d'étanchéité.

 Si deve osservare le direttive corrispondenti di lavorazione di tutti i mestieri partecipanti.

 Si deve osservare le istruzioni di lavorazione del sistema di guarnizione.

Empfohlenes Zubehör / Recommended accessories /
 Aanbevolen toebehoren / Accessoires recommandés /
 Accessori raccomandati:



Poresta® Profi-Flex-Schnellkleber / Profi-Flex fast-setting adhesive / Profi-Flex-snelplakker / Colle Profi-Flex / Collante rapido Profi-Flex



Poresta® Abdichtsystem / Sealing system / Afdichtstelsysteem / Mastic d'étanchéité / Sistema di guarnizione



Poresta® BF Dichtband / Sealing tape / Afdichtingsband / Bande isolante / Fascia isolante



Poresta® BF Dichtband-Innenecke / Sealing tape interior corner / Afdichtingsband-binnenliggende hoek / Bande d'étanchéité pour coin intérieur / Fascia isolante per angolo interno



Poresta® BF Dichtband-Außenecke / Sealing tape exterior corner / Afdichtingsband-buitenliggende hoek / Bande d'étanchéité pour coin extérieur / Fascia isolante per angolo esterno



Geeigneter Fliesenkleber / Suitable tile adhesive / Geschikte tegelplakker / Colle carrelage / Collante per piastrelle adatto



Silikon / Silicone / Siliconen / Silicone / Silicone



22 mm Fliesenprofil (für Naturstein) / 22 mm tegelprofiel (voor natuursteen) / Profil de carreau 22 mm (pour pierre naturelle) / 22 mm tile profile (for natural stone)