



---

## Ihr Online-Fachhändler für:

---



- Kostenlose und individuelle Beratung
- Hochwertige Produkte
- Kostenloser und schneller Versand

- TOP Bewertungen
- Exzelerter Kundenservice
- Über 20 Jahre Erfahrung



**E-Mail: [info@unidomo.de](mailto:info@unidomo.de) | Tel.: 04621 - 30 60 89 0 | [www.unidomo.de](http://www.unidomo.de)**

## Einbauanleitung

Poresta® Schallschutzset BEDS – Matten-Punktverklebung

## Mounting instructions

Poresta® sound insulation set BEDS - spot-bonded mats

## Montagehandleiding

Poresta® Geluidsisolatieset BEDS – Matten met puntverlijming

## Instructions de montage

Set d'isolation acoustique Poresta® BEDS - collage par points du matelas

## Istruzioni di montaggio

Set d'isolamento acustico Poresta® BEDS - Stuoie con incollaggio a punti

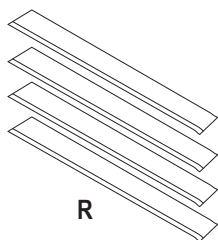

Poresta® Randdämmstreifen /  
Edge insulation strips /  
Randdichtingsstroken /  
Bande isolante de bord /  
Fascia isolante di bordo

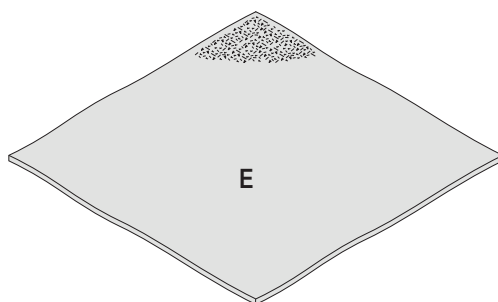

Poresta® Schallentkopplungsmatte /  
Antiresonant mat /  
Geluidsisolatiemat /  
Matelas d'isolation acoustique /  
Stuoia d'isolamento acustico

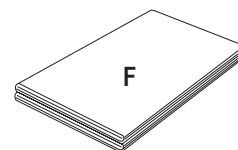

Poresta® Entkopplungsbahn /  
Antiresonant layer /  
Isolatiebaan /  
Bande d'isolation acoustique /  
Telo d'isolamento

For notes and further information see page 5 /  
Aanwijzingen en verdere informatie zie pagina 5 /  
Renseignements et informations complémentaires, voir page 6 /  
Riferimenti e ulteriori informazioni, vedi pagina 6

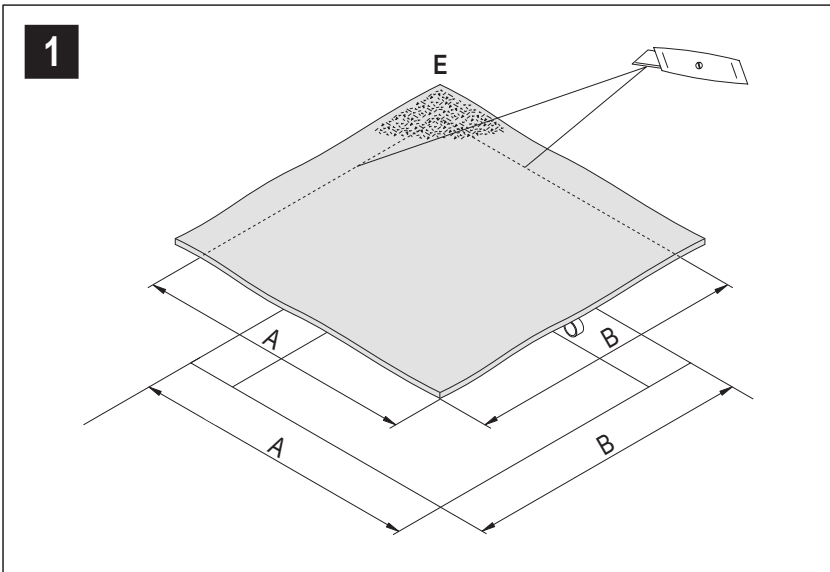

Die einschlägigen Verarbeitungsrichtlinien aller beteiligten Gewerke sind zu berücksichtigen.



Für die Verwendung des Schallschutzsets in Verbindung mit den Poresta® bodenebenen Duschsystemen sind Schallprüfzeugnisse verfügbar. Zur Einhaltung der gemessenen Installationsschallpegel müssen die aufgeführten Poresta® Produkte fachgerecht verwendet werden.

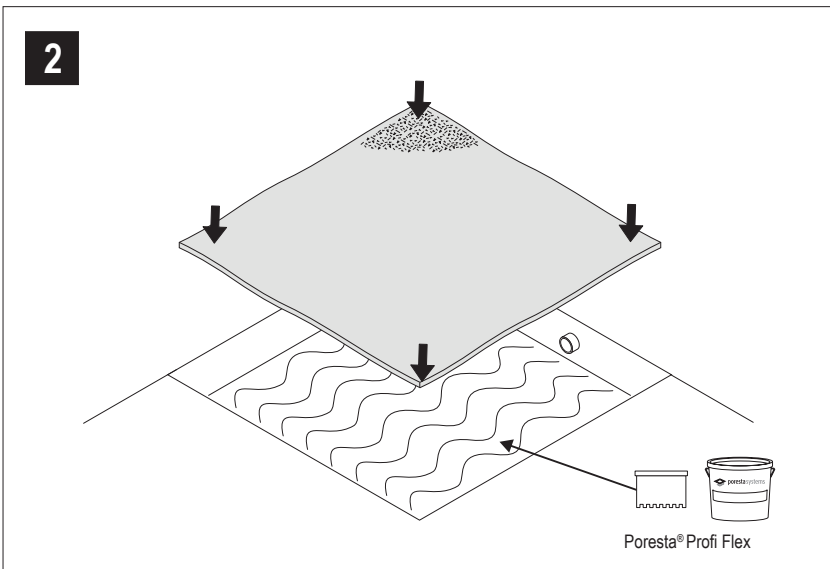

Für den Einbau muss ein ebener, sauberer, tragfähiger und schwingungsfreier Untergrund vorhanden sein.



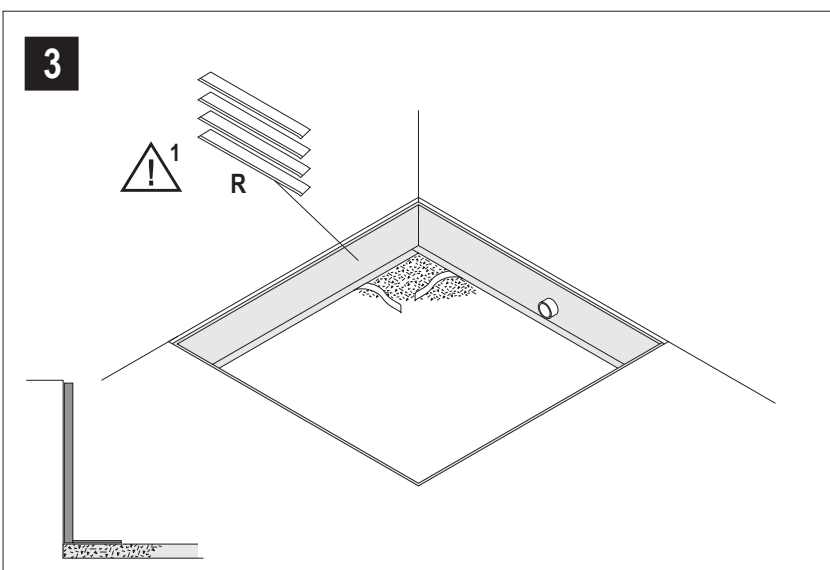

Der Boden im Bereich des Duschsystems muss planeben sein (gegebenenfalls mit Ausgleichsmasse nacharbeiten).



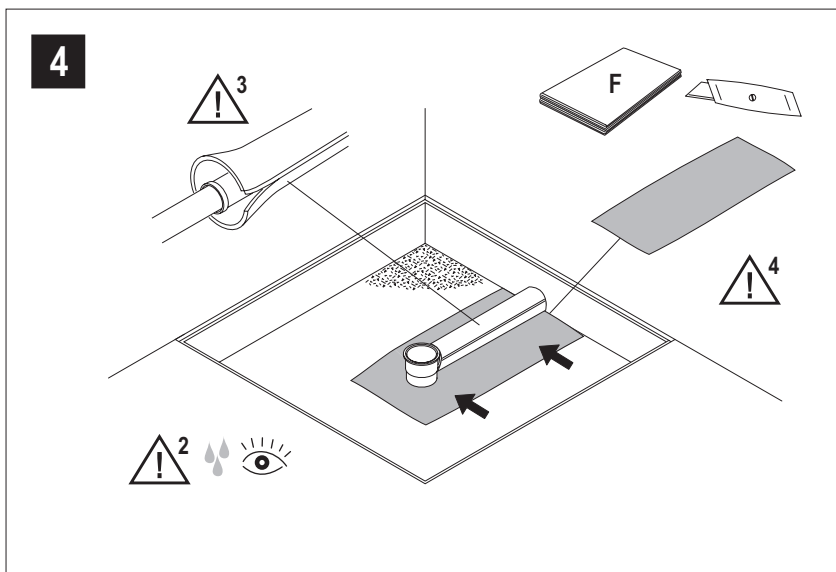

**1** Randdämmstreifen umlaufend auf die Schallentkopplungsmatte kleben.

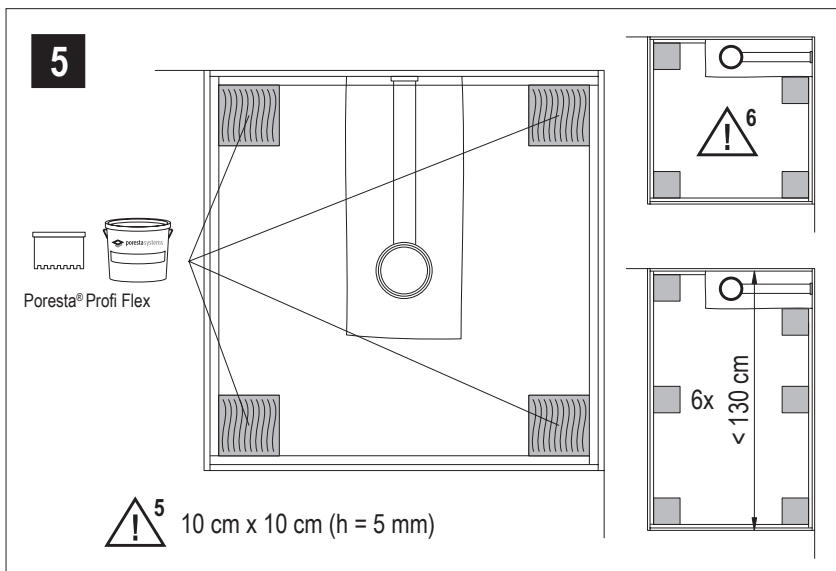

-  **2** Nach Installation der Ablaufgarnitur ist eine Dichtigkeitsprüfung durchzuführen.
-  **3** Vor dem Verschließen des Ablaufschachtes eine geeignete Wärme- und Schallschutzmantelung (nicht im Lieferumfang) an der Ablaufleitung anbringen.
-  **4** Bei Poresta Produkten bei denen eine Verfüllung des Ablaufschachtes erforderlich ist, ist als Kontaktschutz ein Zuschnitt der Entkopplungsbahn auf die Schallentkopplungsmatte zu legen.



-  **5** Poresta Produkte im Randbereich nur mit Klebepunkten (Fläche 10 cm × 10 cm mit 6/8 mm Kellenverzahnung) aufkleben.
-  **6** Liegt der Ablaufschacht im Randbereich des Duschelements, ist der Klebepunkt neben dem Ablaufschacht anzubringen (siehe Abbildung).

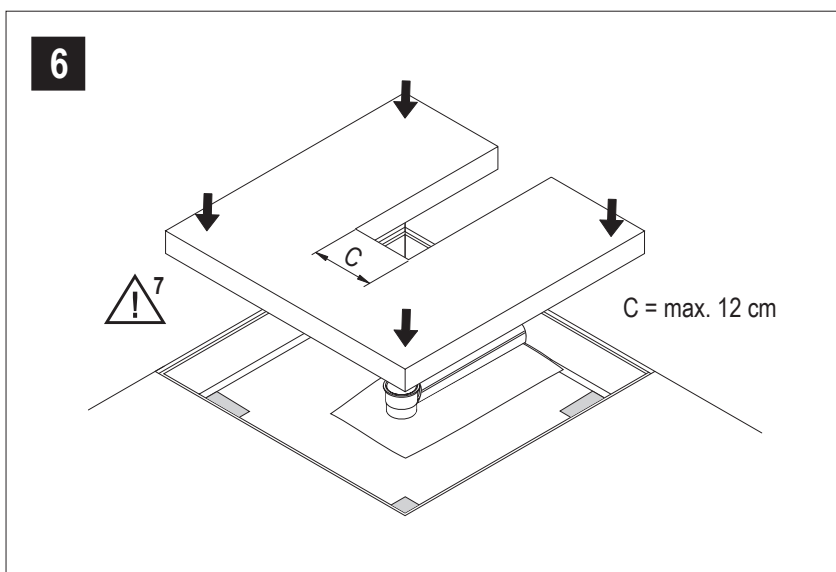



-  **7** Beim Einbau von Unterbauelementen/ Duschsystemen auf die Poresta® Schal-entkopplungsmatte darf kein Fliesenkleber auf der Unterseite des Unterbauelements/ Duschsystems aufgetragen werden.

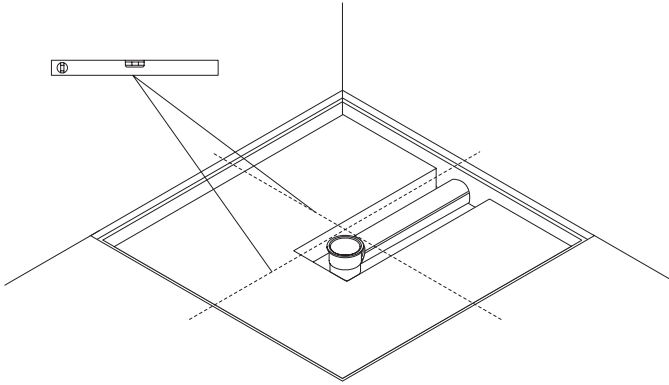



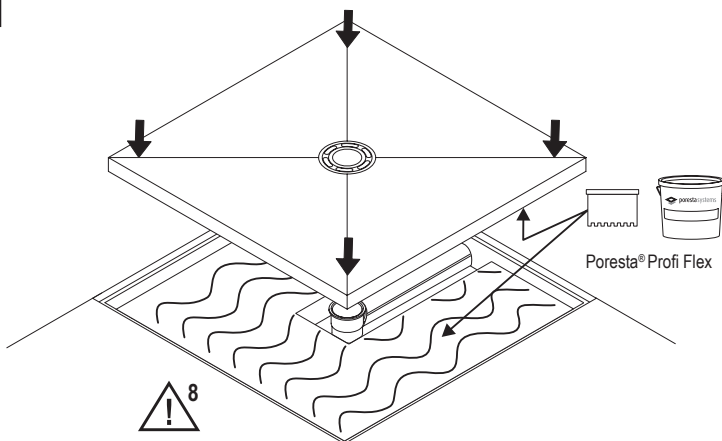



















7



























8



 8 Der weitere Einbau des Duschelementes erfolgt gemäß der jeweiligen Einbauanleitung.

- 
-  The relevant working guidelines of all the trades involved shall be observed.
-  Sound test certificates are available for the use of the sound proofing set in connection with the Poresta® flush shower systems. The Poresta® products must be used expertly to observe the measured installation sound level.
-  For installation, a flat, clean, firm and vibration-less substrate is required.
-  The floor in the area of the shower system should be absolutely flat (if necessary, rework with levelling compound).
-  1 Stick edge insulation strips to the antiresonant mat all around.
-  2 After the installation of the drain fitting, a leak test has to be carried out.
-  3 Before closing the drain duct, provide the drain line with a suitable heat and sound insulation jacketing (not included in the scope of supply).
-  4 For Poresta® products requiring a filling of the drain duct offcuts of the Antiresonant layer are to be laid on the antiresonant mat as contact protection.
-  5 Stick on Poresta® products in the marginal area only with contact spots (surface 10 cm × 10 cm with 6/8 mm toothing).
-  6 If the run-off section is in the edge area of the shower element, the cementing point is to be arranged beside the run-off section (see illustration).
-  7 When installing foundation elements/shower systems on the Poresta® soundproofing mat tile adhesive should not be applied to the underside of the foundation element/shower system.
-  8 Further installation of the shower element is carried out in accordance with the relevant mounting instructions.
-  Rekening houden met de verwerkingsrichtlijnen van alle betrokken leveranciers.
-  Voor de toepassing van de isolatieset in verbinding met Poresta® drempelloze douchesystemen zijn certificaten beschikbaar. Om de mogelijke grenswaarden te bereiken, moeten de genoemde Poresta® producten vakkundig worden verwerkt.
-  Voor montage is een vlakke, schone en zonder vibratie dragende ondergrond aanwezig te zijn.
-  De ondergrond voor het douchesysteem moet gelijkmatig vlak zijn (evt. met spachtelmateriaal bijwerken).
-  1 Plak randdichtingsstroken rondom op de geluidsisolatiemat.
-  2 Na installatie van de afvoergarnituur op dichtheid testen.
-  3 Voor het afsluiten van de afvoerschacht geschikte warmte- en geluidsisolatiemantel (niet in levering inbegrepen) rond de afvoerleiding aanbrengen.
-  4 Voor Poresta® producten welke een vulling van de afvoerschacht nodig hebben, is een op maat gesneden stuk van de Isolatiebaan als contactbescherming op de geluidsisolatiemat te leggen.
-  5 Poresta® producten in the randzone alleen maar met plakpunten (oppervlakte 10 cm × 10 cm met 6/8 mm vertanding) plakken.
-  6 Als de afvoer in de hoek van het douche-element ligt, moet het plakvlak ernaast worden aangebracht (zie afbeelding).
-  7 Bij het monteren van onderbouwelementen/douchesystemen op de Poresta® geluidsisolatiemat mag geen tegelplakker aan de onderkant van het onderbouwelement/douchesysteem worden aangebracht.
-  8 De verdere installatie van het douche-element volgens de betreffende handleiding.
-

-  Les instructions correspondantes de mise en oeuvre de tous les métiers participants sont à respecter.
-  Pour l'utilisation du matériel d'insonorisation en relation avec des systèmes de douche Poresta® à sol plan, des certificats de contrôle du bruit sont disponibles. Pour obtenir les niveaux sonores d'installation mesurés, il est nécessaire d'effectuer la mise en oeuvre des produits Poresta® indiqués conformément aux règles de l'art.
-  Pour le montage, il est nécessaire d'avoir une surface plane, propre, stable et exempte de vibrations.
-  Le sol dans la zone du système de douche doit être plan (le cas échéant, faire des retouches au moyen de masse d'égalisation).
-  1 Coller la bande isolante de bord tout autour de la matelas d'isolation acoustique.
-  2 Après le montage de la garniture d'écoulement, procéder à une épreuve d'étanchéité.
-  3 Avant de fermer le conduit d'évacuation, la tuyauterie d'évacuation doit être pourvue d'une enveloppe calorifuge et insonorisante appropriée (pas comprise dans la fourniture).
-  4 Dans le cas des produits Poresta® nécessitant un remplissage du puits de la conduite d'évacuation, il faut poser de la bande d'isolation acoustique coupée de manière adéquate sur le matelas d'isolation acoustique pour assurer la protection contre le contact direct.
-  5 Dans la zone marginale, ne coller les produits Poresta® qu'au moyen de points adhésifs (surface 10 cm × 10 cm avec endentement 6/8 mm).
-  6 Si le puits d'évacuation se trouve dans la zone marginale de l'élément de douche, il faut prévoir un point de collage à côté du puits d'évacuation (voir figure).
-  7 En cas de montage d'éléments de base/systèmes de douche sur le matelas d'isolation acoustique Poresta® il faut éviter d'appliquer de la colle pour carreaux sur la face inférieure de l'élément de base/du système de douche.
-  8 Le montage ultérieur de l'élément de douche est à effectuer conformément aux instructions de montage respectives.
-  Si deve osservare le istruzioni corrispondenti di lavorazione di tutti i mestieri partecipanti.
-  Per l'utilizzazione del materiale d'insonorizzazione in relazione al sistema di doccia Poresta® a fondo piano sono disponibili certificati di controllo del rumore. Per ottenere i livelli sonori d'installazione misurati è necessario di far attenzione alla messa in opera a regola d'arte dei prodotti Poresta® indicati.
-  Per il montaggio è necessario di avere una superficie piana, pulita, stabile ed esente da vibrazioni.
-  Il pavimento nella zona del sistema di doccia deve essere piano (eventualmente correggere con massa d'appianamento).
-  1 Incollare fasce isolanti di bordo tutt'intorno sul Stuoia d'isolamento acustico.
-  2 Dopo l'installazione del gruppo di scolo, si deve procedere ad una prova di tenuta.
-  3 Prima di fermare il canale di scolo, la condotta di scarico deve essere provvista di un rivestimento termoisolante e insonorizzante appropriato (non compreso nella fornitura).
-  4 Per prodotti Poresta® per i quali è necessario un riempimento del canale di scolo si deve mettere un pezzo tagliato a misura del Telo d'isolamento sulla stuoia d'isolamento acustico come protezione di contatto.
-  5 Incollare prodotti Poresta® nell'area marginale solo nei punti d'adesione (superficie 10 cm × 10 cm per mezzo di dentatura 6/8 mm).
-  6 Se il pozzo di scarico si trova nella zona marginale dell'elemento di doccia, il punto d'incollatura deve essere previsto accanto al pozzo di scarico (vedi figura).
-  7 In caso del montaggio d'elementi di base/di sistemi di doccia sulla stuoia d'isolamento acustico Poresta® evitare d'applicare colla per piastrelle sul lato inferiore dell'elemento di base/ del sistema di doccia.
-  8 L'installazione ulteriore dell'elemento di doccia deve essere eseguita in conformità alle istruzioni di montaggio rispettive.