



UNIDOMO®

Web: www.unidomo.de

Telefon: 04621- 30 60 89 0

Mail: info@unidomo.com

Öffnungszeiten: Mo.-Fr. 8:00-17:00 Uhr

VIESSMANN

Buderus

 **Vaillant**

WOLF

 **JUNKERS**  **BOSCH**



 **remeha**

 **DAIKIN**

ROTEX

a member of DAIKIN group



-  Individuelle Beratung
-  Kostenloser Versand
-  Hochwertige Produkte

-  Komplettpakete
-  Über 15 Jahre Erfahrung
-  Markenhersteller

AXOR

DE / Gebrauchsanleitung / Montageanleitung	2
FR / Mode d'emploi / Instructions de montage	2
EN / Instructions for use / assembly instructions	3
IT / Istruzioni per l'uso / Istruzioni per Installazione	3
ES / Modo de empleo / Instrucciones de montaje	4
NL / Gebruiksaanwijzing / Handleiding	4
DK / Brugsanvisning / Monteringsvejledning	5
PT / Instruções para uso / Manual de Instalação	5
PL / Instrukcja obsługi / Instrukcja montażu	6
CS / Návod k použití / Montážní návod	6
SK / Návod na použitie / Montážny návod	7
ZH / 用户手册 / 组装说明	7
RU / Руководство пользователя / Инструкция по монтажу	8
FI / Käyttöohje / Asennusohje	8
SV / Bruksanvisning / Monteringsanvisning	9
LT / Vartotojo instrukcija / Montavimo instrukcijos	9
HR / Upute za uporabu / Uputstva za instalaciju	10
TR / Kullanım kılavuzu / Montaj kılavuzu	10
RO / Manual de utilizare / Instrucțiuni de montare	11
EL / Οδηγίες χρήσης / Οδηγία συναρμολόγησης	11
SL / Navodilo za uporabo / Navodila za montažo	12
ET / Kasutusjuhend / Paigaldusjuhend	12
LV / Lietošanas pamācība / Montāžas instrukcija	13
SR / Uputstvo za upotrebu / Uputstvo za montažu	13
NO / Bruksanvisning / Montasjeveiledning	14
BG / Инструкция за употреба / Ръководство за монтаж	14
SQ / Udhëzuesi i përdorimit / Udhëzime rreth montimit	15
AR / دليل الاستخدام / تعليمات التجميع	15
HU / Használati útmutató / Szerelési útmutató	16



AXOR Flexaplus S
58312000 / 58312820
58312930



AXOR Flexaplus
58311000

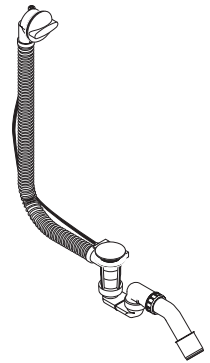
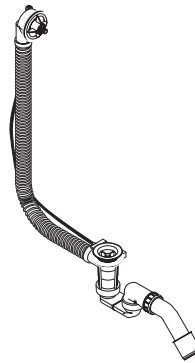

AXOR Flexaplus
58313180 / 58314180

AXOR Flexaplus
58315000

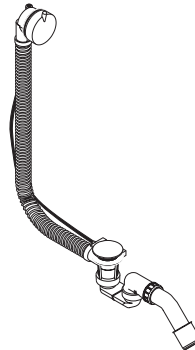

AXOR Flexaplus S
58316000 / 58316820
58316930

⚠ SICHERHEITSHINWEISE

- ⚠ Bei der Montage müssen zur Vermeidung von Quetsch- und Schnittverletzungen Handschuhe getragen werden.
- ⚠ Das Produkt darf nur zu Bade-, Hygiene- und Körperreinigungszwecken eingesetzt werden.







MONTAGEHINWEISE

- / Vor der Montage muss das Produkt auf Transportschäden untersucht werden. Nach dem Einbau werden keine Transport- oder Oberflächenschäden anerkannt.
- / Die Leitungen und die Armatur müssen nach den gültigen Normen montiert, gespült und geprüft werden.
- / Die in den Ländern jeweils gültigen Installationsrichtlinien sind einzuhalten.
- / Der Ablauf muss spannungsfrei verlegt werden!
- / Funktionsprüfung (siehe Seite 19) Abb. 8
- / Dichtheitsprüfung (siehe Seite 19) Abb. 9
- / 58316000, 58316820, 58316930, 58312000, 58312820, 58312930: Durch Anwendung des Stauelementes (Kunststoffeinsatzes) kann die maximale Füllhöhe der Badewanne um ca. 25 mm erhöht werden. Es muss geprüft werden, dass die Zulaufleitung nicht größer als die Überlaufleistung ist!

TECHNISCHE DATEN

Ablaufleistung:	64 l/min
Überlaufleistung:	42 l/min

SYMBOLERKLÄRUNG

-  Kein essigsäurehaltiges Silikon verwenden!
-  MASSE (siehe Seite 17)
-  SERVICE TEILE (siehe Seite 23)
-  REINIGUNG (siehe Seite 24)
-  BEDIENUNG (siehe Seite 22)
-  PRÜFZEICHEN (siehe Seite 22)

MONTAGE (siehe Seite 18) 

⚠ CONSIGNES DE SÉCURITÉ

- ⚠ Lors du montage, porter des gants de protection pour éviter toute blessure par écrasement ou coupure.
- ⚠ Le produit ne doit servir qu'à se laver et à assurer l'hygiène corporelle.







INSTRUCTIONS POUR LE MONTAGE

- / Avant son montage, s'assurer que le produit n'a subi aucun dommage pendant le transport. Après le montage, tout dommage de transport ou de surface ne pourra pas être reconnu.
- / Les conduites et la robinetterie doivent être montés, rincés et contrôlés selon les normes en vigueur.
- / Les directives d'installation en vigueur dans le pays concerné doivent être respectées.
- / Le vidage doit être monté sans aucune tension!
- / Test de fonctionnement (voir pages 19) Fig. 8
- / Mise à l'épreuve pour l'étanchéité (voir pages 19) Fig. 9
- / 58316000, 58316820, 58316930, 58312000, 58312820, 58312930: Grâce à l'utilisation de l'élément de retenue (barrage synthétique) on pourra augmenter la hauteur de remplissage de la baignoire jusqu'à 25 mm. Il faudra vérifier que le débit de l'alimentation ne soit pas supérieur à celui de l'évacuation.

INFORMATIONS TECHNIQUES

Débit d'écoulement:	64 l/min
capacité d'évacuation:	42 l/min

DESCRIPTION DU SYMBOLE

-  Ne pas utiliser de silicone contenant de l'acide acétique!
-  DIMENSIONS (voir pages 17)
-  PIÈCES DÉTACHÉES (voir pages 23)
-  NETTOYAGE (voir pages 24)
-  INSTRUCTIONS DE SERVICE (voir page 22)
-  CLASSIFICATION ACOUSTIQUE ET DÉBIT (voir pages 22)

MONTAGE (voir pages 18) 

⚠ SAFETY NOTES

- ⚠ Gloves should be worn during installation to prevent crushing and cutting injuries.
- ⚠ The product may only be used for bathing, hygienic and body cleaning purposes.







INSTALLATION INSTRUCTIONS

- / Prior to installation, inspect the product for transport damages. After it has been installed, no transport or surface damage will be honoured.
- / The pipes and the fixture must be installed, flushed and tested as per the applicable standards.
- / The plumbing codes applicable in the respective countries must be observed.
- / The tub must be instal-led stressfree!
- / Functional testing (see page 19) Fig. 8
- / Leakage test (see page 19) Fig. 9
- / 58316000, 58316820, 58316930, 58312000, 58312820, 58312930: By using the dam element (synthetic insert) the maximum filling height of the bath tub can be increased by up to 25 mm. However, one needs to check that the inflow capacity does not exceed the overflow capacity.

TECHNICAL DATA

Sequence power:	64 l/min
overflow capacity:	42 l/min

SYMBOL DESCRIPTION

-  Do not use silicone containing acetic acid!
-  DIMENSIONS (see page 17)
-  SPARE PARTS (see page 23)
-  CLEANING (see page 24)
-  OPERATION (see page 22)
-  TEST CERTIFICATE (see page 22)

ASSEMBLY (see page 18)



⚠ INDICAZIONI SULLA SICUREZZA

- ⚠ Durante il montaggio, per evitare ferite da schiacciamento e da taglio bisogna indossare guanti protettivi.
- ⚠ Il prodotto deve essere utilizzato esclusivamente per fare il bagno e per l'igiene del corpo.







ISTRUZIONI PER IL MONTAGGIO

- / Prima del montaggio è necessario controllare che non ci siano stati danni durante il trasporto. Una volta eseguito il montaggio, non verranno riconosciuti eventuali danni di trasporto o delle superfici.
- / Montare, lavare e controllare tubature e rubinetteria rispettando le norme correnti.
- / Vanno rispettate le direttive di installazione nazionali vigenti nel rispettivo paese.
- / il tubo di scarico deve essere installato senza impedimenti circostanti!
- / Prova di funzionamento (vedi pagg. 19) Fig. 8
- / Test di tenuta (vedi pagg. 19) Fig. 9
- / 58316000, 58316820, 58316930, 58312000, 58312820, 58312930: l'utilizzo nelle colonne di scarico di tubi in materie plastiche o sintetiche inadeguati può causare alla funzione del troppopieno un innalzamento di 25 mm. Si deve verificare che la portata d'acqua non sia maggiore della capacità del troppopieno.

DATI TECNICI

Portata di scarico:	64 l/min
capacità del troppopieno:	42 l/min

DESCRIZIONE SIMBOLO

-  Non utilizzare silicone contenente acido acetico!
-  INGOMBRI (vedi pagg. 17)
-  PARTI DI RICAMBIO (vedi pagg. 23)
-  PULITURA (vedi pagg. 24)
-  PROCEDURA (vedi pagg. 22)
-  SEGNO DI VERIFICA (vedi pagg. 22)

MONTAGGIO (vedi pagg. 18)



△ INDICACIONES DE SEGURIDAD

- △ Durante el montaje deben utilizarse guantes para evitar heridas por aplastamiento o corte.
- △ El producto solo debe ser utilizado para fines de baño, higiene y limpieza corporal.







INDICACIONES PARA EL MONTAJE

- / Antes del montaje se debe examinar el producto contra daños de transporte. Después de la instalación no se reconoce ningún daño de transporte o de superficie.
- / Los conductos y la grifería deben montarse, lavarse y comprobarse según las normas vigentes.
- / Es obligatorio el cumplimiento de las directrices de instalación vigentes en el país respectivo.
- / El vaciador debe instalarse sin tensiones entre los componentes!
- / Comprobación de funcionamiento (ver página 19) Fig. 8
- / Comprobación de estanqueidad (ver página 19) Fig. 9
- / 58316000, 58316820, 58316930, 58312000, 58312820, 58312930: Mediante el uso de este prolongador (de material acrílico) se puede aumentar el llenado de la bañera 25mm más. Hay que comprobar que el agua no supere la altura del prolongador.

DATOS TÉCNICOS

Capacidad de desagüe: 64 l/min
 capacidad de rebose: 42 l/min

DESCRIPCIÓN DE SÍMBOLOS

-  No utilizar silicona que contiene ácido acético!
-  **DIMENSIONES** (ver página 17)
-  **REPUESTOS** (ver página 23)
-  **LIMPIAR** (ver página 24)
-  **MANEJO** (ver página 22)
-  **MARCA DE VERIFICACIÓN** (ver página 22)

△ VEILIGHEIDSLINSTRUCTIES

- △ Bij de montage moeten ter voorkoming van knel- en snijwonden handschoenen worden gedragen.
- △ Het product mag alleen voor het wassen, hygiënische doeleinden en voor de lichaamreiniging worden gebruikt.



MONTAGE-INSTRUCTIES

- / Vóór de montage moet het product gecontroleerd worden op transportschade. Na de inbouw wordt geen transport- of oppervlakteschade meer aanvaard.
- / De leidingen en armaturen moeten gemonteerd, gespoeld en gecontroleerd worden volgens de geldige normen.
- / De in de overeenkomstige landen geldende installatierichtlijnen moeten nageleefd worden.
- / De afvoer moet vrij van spanning worden gelegd!
- / Functietest (zie blz. 19) Afb. 8
- / Test op dichtheid (zie blz. 19) Afb. 9
- / 58316000, 58316820, 58316930, 58312000, 58312820, 58312930: Door toepassing van de grijze kunststof inzet kan de maximale waterhoogte waarmee het bad kan worden gevuld met 25 mm worden verhoogd. Vooraf moet worden getest of de toevoercapaciteit niet groter is dan de afvoercapaciteit.

TECHNISCHE GEGEVENS

Afvoercapaciteit: 64 l/min
 overloopcapaciteit: 42 l/min

SYMBOOLBESCHRIJVING

-  Gebruik geen zuurhoudende siliconen!
-  **MATEN** (zie blz. 17)
-  **SERVICE ONDERDELEN** (zie blz. 23)
-  **REINIGEN** (zie blz. 24)
-  **BEDIENING** (zie blz. 22)
-  **KEURMERK** (zie blz. 22)

△ SIKKERHEDSANVISNINGER

- △ Ved monteringen skal der bruges handsker for at undgå kvæstelser og snitsår.
- △ Produktet må kun bruges til bade-, hygiejne og kropsurengøringsformål.







MONTERINGSANVISNINGER

- / Før monteringen skal produktet kontrolleres for transportskader. Efter monteringen godkendes transportskader eller skader på overfladen ikke længere.
- / Ledningerne og armaturerne skal monteres, skylles og kontrolleres iht. de gældende standarder.
- / Installationsbestemmelserne, der gælder i det enkelte land, skal overholdes.
- / Afløbet skal nedlægges uden spændinger!
- / Funktionskontrol (se s. 19) Fig. 8
- / Lækage test (se s. 19) Fig. 9
- / 58316000, 58316820, 58316930, 58312000, 58312820, 58312930: Ved brug af vandstandsforhøjerkappen (kunststof-halvmåne) kan den maximale vandstand i badekarret forøges med op til 25 mm. Vær dog opmærksom på, at ved brug af denne vandstandsforhøjerkappe vil overløbskapaciteten blive reduceret, og det er derfor vigtigt, at vandpåfyldningskapaciteten ikke overstiger overløbskapaciteten.

TEKNISKE DATA

Afløbskapacitet:	64 l/min
overløbskapaciteten:	42 l/min

SYMBOLBESKRIVELSE

-  Der må ikke benyttes eddikesyreholdig silikone!
-  MÅLENE (se s. 17)
-  RESERVEDELE (se s. 23)
-  RENGØRING (se s. 24)
-  BRUGSANVISNING (se s. 22)
-  GODKENDELSE (se s. 22)

△ AVISOS DE SEGURANÇA

- △ Durante a montagem devem ser utilizadas luvas de proteção, de modo a evitar ferimentos resultantes de entalamentos e de cortes.
- △ O produto só pode ser utilizado para fins de higiene pessoal.







AVISOS DE MONTAGEM

- / Antes da montagem deve-se controlar o produto relativamente a danos de transporte. Após a montagem não são aceites quaisquer danos de transporte ou de superfície.
- / As tubagens e a torneira têm que ser montadas, enxaguadas e verificadas de acordo com as normas em vigor.
- / A prescrições de instalação válidas nos respetivos países devem ser respeitadas.
- / O escoamento tem que ser instalado sem tensão!
- / Controlo de funcionamento (ver página 19) Fig. 8
- / Teste de vedação (ver página 19) Fig. 9
- / 58316000, 58316820, 58316930, 58312000, 58312820, 58312930: Através da utilização do elemento de estanquidade (peça plástica), o nível máximo de água da banheira pode ser aumentado até 25 mm. Deve ser verificado se a capacidade de entrada de água não é superior à capacidade de escoamento da mesma.

DADOS TÉCNICOS

Capacidade de escoamento:	64 l/min
capacidade de escoamento:	42 l/min

DESCRIÇÃO DO SÍMBOLO

-  Não utilizar silicone que contenha ácido acético!
-  MEDIDAS (ver página 17)
-  PEÇAS DE SUBSTITUIÇÃO (ver página 23)
-  LIMPEZA (ver página 24)
-  FUNCIONAMENTO (ver página 22)
-  MARCA DE CONTROLO (ver página 22)



△ WSKAZÓWKI BEZPIECZEŃSTWA

- △ Aby uniknąć zranień na skutek zgniecenia lub przecięcia, podczas montażu należy nosić rękawice ochronne.
- △ Produkt może być używany tylko do kąpieli, higieny i czyszczenia ciała.







WSKAZÓWKI MONTAŻOWE

- / Przed montażem należy skontrolować produkt pod kątem szkód transportowych. Po montażu nie widać żadnych szkód transportowych ani szkód na powierzchni.
- / Przewody i armatura muszą być montowane, płukane i kontrolowane według obowiązujących norm.
- / Należy przestrzegać wytycznych instalacyjnych obowiązujących w danym kraju.
- / Odpływ musi być położony bez naprężeń!
- / Sprawdzenie działania (patrz strona 19) Rys. 8
- / Kontrola szczelności (patrz strona 19) Rys. 9
- / 58316000, 58316820, 58316930, 58312000, 58312820, 58312930: Przy użyciu elementu spiętrzającego (wkładka z tworzywa sztucznego) można zwiększyć maksymalną wysokość napełnienia wanny o ok. 25 mm. Należy zadbać o to, by wydajność dopływu nie była większa niż wydajność przelewu.

DANE TECHNICZNE

Wydajność odpływu: 64 l/min
wydajność przelewu: 42 l/min

OPIS SYMBOLU

-  Nie stosować silikonów zawierających kwas octowy!
-  WYMIARY (patrz strona 17)
-  CZĘŚCI SERWISOWE (patrz strona 23)
-  CZYSZCZENIE (patrz strona 24)
-  OBSŁUGA (patrz strona 22)
-  ZNAK JAKOŚCI (patrz strona 22)

MONTAŻ (patrz strona 18)



△ BEZPEČNOSTNÍ POKYNY

- △ Pro zabránění řezným zraněním a pohmožděninám je nutné při montáži nosit rukavice.
- △ Produkt smí být používán pouze ke koupání a za účelem tělesné hygieny.







POKYNY K MONTÁŽI

- / Před montáží je třeba produkt zkontrolovat, zda nebyl při transportu poškozen. Po zabudování nebudou uznány žádné škody způsobené transportem nebo poškození povrchu.
- / Vedení a armatura musí být namontovány, propláchnuty a otestovány podle platných norem.
- / Je třeba dodržovat montážní pravidla platná v dané zemi.
- / Odtok musí být instalován beznapěťově!
- / Zkouška funkce (viz strana 19) Obr. 8
- / zkouška těsnosti (viz strana 19) Obr. 9
- / 58316000, 58316820, 58316930, 58312000, 58312820, 58312930: Použitím vzdouvacího prvku (vločka z umělé hmoty) je možno zvýšit maximální naplnění vany o zhruba 25 mm. Musí se však zjistit, zda výkon na přívodu není vyšší než na přetoku.

TECHNICKÉ ÚDAJE

Výkon odtoku: 64 l/min
výkon na přetoku: 42 l/min

POPIS SYMBOLŮ

-  Nepoužívat silikon s obsahem kyseliny octové!
-  ROZMĚRY (viz strana 17)
-  SERVISNÍ DÍLY (viz strana 23)
-  ČIŠTĚNÍ (viz strana 24)
-  OVLÁDÁNÍ (viz strana 22)
-  ZKUŠEBNÍ ZNAČKA (viz strana 22)

MONTÁŽ (viz strana 18)



△ BEZPEČNOSTNÉ POKYNY

- △ Pri montáži musíte nosiť rukavice, aby ste predišli pomliaždeninám a rezným poraneniam.
- △ Produkt sa smie používať len na kúpanie a telesnú hygienu.







POKYNY PRE MONTÁŽ

- / Pred montážou musíte produkt skontrolovať, či nebol počas transportu poškodený. Po zabudovaní nebudú uznané žiadne škody spôsobené transportom alebo poškodenia povrchu.
- / Ledningarna och blandaren måste monteras, spolansigenom och kontrolleras enligt de gällande normerna.
- / Je potrebné dodržiavať smernice o inštalácii, ktoré sú práve teraz platné v krajinách.
- / Odtok musí byť inštalovaný beznapäťovo!
- / Skúška funkcie (viď strana 19) Obr. 8
- / Skúška tesnosti (viď strana 19) Obr. 9
- / 58316000, 58316820, 58316930, 58312000, 58312820, 58312930: Použitím uzatváracieho prvku (plastová vložka) sa môže zvýšiť maximálna výška naplnenia vane o asi 25 mm. Musí sa skontrolovať, že prítok nie je väčší ako prepad!

TECHNICKÉ ÚDAJE

Výkon odtoku:	64 l/min
výdatnosť prepadu:	42 l/min

POPIS SYMBOLOV

-  Nepoužívať silikón s obsahom kyseliny octovej!
-  ROZMERY (viď strana 17)
-  SERVISNÉ DIELY (viď strana 23)
-  ČISTENIE (viď strana 24)
-  OBSLUHA (viď strana 22)
-  OSVEDČENIE O SKÚŠKE (viď strana 22)

△ 安全技巧

- △ 装配时为避免挤压和切割受伤，必须戴上手套。
- △ 本产品只允许作为洗浴、卫生和洁身之用。







安装提示

- / 安装前必须检查产品是否受到运输损害。安装后将不认可运输损害或表面损伤。
- / 管道和阀门必须根据通用标准进行安装、冲洗和检查。
- / 请遵守当地国家现行的安装规定。
- / 地漏必须无应力铺设！
- / 功能检查 (参见第 19 页) 第 8
- / 漏水测试 (参见第 19 页) 第 9
- / 58316000, 58316820, 58316930, 58312000, 58312820, 58312930: 通过使用挡板元件 (合成嵌件), 浴盆的最高加水高度最多可以增加 25 mm。但是, 需要检查确定进水能力不超过溢水能力。

技术参数

流出功率:	64 升/分钟
溢水槽:	42 升/分钟

符号说明

-  请勿使用含有乙酸的硅胶！
-  大小 (参见第 17 页)
-  备用零件 (参见第 23 页)
-  清洗 (参见第 24 页)
-  操作 (参见第 22 页)
-  检验标记 (参见第 22 页)



△ УКАЗАНИЯ ПО ТЕХНИКЕ БЕЗОПАСНОСТИ

- △ Во время монтажа следует надеть перчатки во избежание прищемления и порезов.
- △ Изделие разрешается использовать только в гигиенических целях: для принятия ванны и личной гигиены.







УКАЗАНИЯ ПО МОНТАЖУ

- / Перед монтажом следует проверить изделие на предмет повреждений при перевозке. После монтажа претензии о возмещении ущерба за повреждения при перевозке или повреждения поверхностей не принимаются.
- / Трубы и арматура должны быть установлены, промыты и проверены в соответствии с действующими нормами.
- / Необходимо соблюдать требования по монтажу, действующие в соответствующих странах.
- / Прокладка отвода должна осуществляться без нагрузки!
- / Эксплуатационная проверка (см. стр. 19) рис. 8
- / Проверка плотности (см. стр. 19) рис. 9
- / 58316000, 58316820, 58316930, 58312000, 58312820, 58312930: При использовании закрывающего элемента (пластмассовая вставка) максимальную высоту наполнения ванны можно увеличить прибл. на 25 мм. Необходимо убедиться в том, что производительность подвода не превышает производительность перелива!

ТЕХНИЧЕСКИЕ ДАННЫЕ

Перерабатывающая способность: 64 л/мин
 производительность перепускного устройства: 42 л/мин

ОПИСАНИЕ СИМВОЛОВ

-  Не применяйте силикон, содержащий уксусную кислоту.
-  РАЗМЕРЫ (см. стр. 17)
-  КОМПЛЕКТ (см. стр. 23)
-  ОЧИСТКА (см. стр. 24)
-  ЭКСПЛУАТАЦИЯ (см. стр. 22)
-  ЗНАК ТЕХНИЧЕСКОГО КОНТРОЛЯ (см. стр. 22)

МОНТАЖ (см. стр. 18)



△ TURVALLISUUSOHJEET

- △ Asennuksessa on käytettävä käsiineitä puristumien ja viiltojen aiheuttamien tapaturmien estämiseksi.
- △ Tuotetta saa käyttää ainoastaan kylpy-, hygienia- ja puhdistustarkoituksiin.







ASENNUSOHJEET

- / Ennen asennusta on tarkastettava tuotteen mahdolliset kuljetusvahingot. Asennuksen jälkeen kuljetus- ja pintavaurioita ei hyväksytä.
- / Putket ja hana on asennettava, huuhdeltava ja tarkastettava voimassa olevien standardien mukaisesti.
- / Jokaisessa maassa on noudatettava siellä päteviä asennusohjeita.
- / Vedenpoisto on asennettava siten, että se ei jää jännitykseen!
- / Toimintatarkastus (katso sivu 19) kuva 8
- / Tiiviystarkastus (katso sivu 19) kuva 9
- / 58316000, 58316820, 58316930, 58312000, 58312820, 58312930: Kylpyammeen maksimia täyttökorkeutta voidaan lisätä 25 mm käyttämällä patoelementtiä (muovinen sisuselementti). Tällöin on tarkastettava, että tulevan veden määrä ei ylitä ylivuotavan veden määrää!

TEKNISET TIEDOT

Poistoteho: 64 l/min
 ylivalumamäärä: 42 l/min

MERKIN KUVAUS

-  Älä käytä etikkahappopitoista silikonial
-  MITAT (katso sivu 17)
-  VARAOSAT (katso sivu 23)
-  PUHDISTUS (katso sivu 24)
-  KÄYTTÖ (katso sivu 22)
-  KOESTUSMERKKI (katso sivu 22)

ASENNUS (katso sivu 18)



△ SÄKERHETSANVISNINGAR

- △ Handskar ska bäras under monteringsarbetet så att man kan undvika kläm- och skärskador.
- △ Produkten får bara användas till kroppshygien med bad och dusch.







MONTERINGSANVISNINGAR

- / Det måste undersökas om produkten har transportskador innan den monteras. Efter monteringen accepteras inga transport- eller ytskiktsskador.
- / Ledningarna och blandaren måste monteras, spolats igenom och kontrolleras enligt de gällande normerna.
- / De installationsriktlinjer som gäller i länderna ska följas.
- / Avloppet måste läggas spänningsfritt!
- / Funktionskontroll (se sidan 19) Bild 8
- / Kontrollera tätheten (se sidan 19) Bild 9
- / 58316000, 58316820, 58316930, 58312000, 58312820, 58312930: Om ett vattennivåfilter används (plastinsats) kan den maximala fyllhöjden i karet ökas med ca. 25 mm. Här måste det dock kontrolleras att inte inflödeseffekten är större än överrinningseffekten!

TEKNISKA DATA

Tömningskapacitet:	64 l/min
överflödeseffekten:	42 l/min

SYMBOLFÖRKLARING

-  Använd inte silikon som innehåller ättiksyra!
-  MÅTTEN (se sidan 17)
-  RESERVDLAR (se sidan 23)
-  RENGÖRING (se sidan 24)
-  HANTERING (se sidan 22)
-  TESTSIGILL (se sidan 22)

△ SAUGUMO TECHNIKOS NURODYMAI

- △ Apsaugai nuo užspaudimo ir įsijovimo montavimo metu mūvėkite pirštines.
- △ Gaminy turi būti naudojamas tik maudymuisi, kūno higienai ir švarai palaikyti.







MONTAVIMO INSTRUKCIJA

- / Prieš montuojant būtina patikrinti, ar gaminy nebuvo pažeistas transportavimo metu. Sumontavus pretenzijos dėl transportavimo ir paviršiaus pažeidimų nepriimamos.
- / Vamzdžiai ir sujungimai turi būti montuojami, plaunami ir tikrinami pagal galiojančias normas.
- / Laikytės atitinkamoje šalyje galiojančių direktyvų dėl įrengimo.
- / Išbėgimo vamzdžiai turi būti pakloti be įtampos!
- / Veikimo patikrinimas (žr. psl. 19) Pav. 8
- / Sandarumo patikrinimas (žr. psl. 19) Pav. 9
- / 58316000, 58316820, 58316930, 58312000, 58312820, 58312930: Naudojant specialų sintetinį elementą galima padidinti maksimalų vandens lygį vonioje apie 25 mm. Būtina patikrinti ar įbėgančio vandens kiekis neviršija išbėgančio kiekio.

TECHNINIAI DUOMENYS

Išėjimo reikšmė:	64 l/min
išbėgančio vandens kiekis:	42 l/min

SIMBOLIO APRAŠYMAS

-  Nenaudokite silikono, kurio sudėtyje yra acto rūgšties!
-  IŠMATAVIMAI (žr. psl. 17)
-  ATSARGINĖS DALYS (žr. psl. 23)
-  VALYMAS (žr. psl. 24)
-  EKSPLOATACIJA (žr. psl. 22)
-  BANDYMO PAŽYMA (žr. psl. 22)



△ SIGURNOSNE UPUTE

- △ Prilikom montaže se radi sprječavanja prignječenja i posjekotina moraju nositi rukavice.
- △ Proizvod se smije primjenjivati samo za kupanje, tuširanje i osobnu higijenu.







UPUTE ZA MONTAŽU

- / Prije montaže mora se provjeriti je li proizvod oštećen prilikom transporta. Nakon ugradnje se ne priznaju nikakve reklamacije koje se odnose na površinska i transportna oštećenja.
- / Cijevi i armatura moraju biti postavljeni, isprani i testirani prema važećim normama.
- / Obvezno se moraju uvažiti propisi o instalacijama koji vrijede u dotičnoj zemlji.
- / Odvod se mora tako položiti da ne bude izložen naprezanju!
- / Provjera funkcioniranja (pogledaj stranicu 19) Sl. 8
- / Ispitivanje brtvljenja (pogledaj stranicu 19) Sl. 9
- / 58316000, 58316820, 58316930, 58312000, 58312820, 58312930: Upotrebom plastičnog umetka razina vode u kadi može se povećati za oko 25 mm. Pritom treba paziti da količina vode nije veća od dozvoljenog kapaciteta!

TEHNIČKI PODATCI

Protok vode:	64 l/min
dozvoljeni kapacitet:	42 l/min

OPIS SIMBOLA

-  Nemojte koristiti silikon koji sadrži octenu kiselinu!
-  MJERE (pogledaj stranicu 17)
-  REZERVNI DJELOVI (pogledaj stranicu 23)
-  ČIŠĆENJE (pogledaj stranicu 24)
-  UPOTREBA (pogledaj stranicu 22)
-  OZNAKA TESTIRANJA (pogledaj stranicu 22)

SASTAVLJANJE (pogledaj stranicu 18) 

△ GÜVENLİK UYARILARI

- △ Montaj esnasında ezilme ve kesilme gibi yaralanmaları önlemek için eldiven kullanılmalıdır.
- △ Ürün yalnızca banyo, hijyen ve beden temizliği amaçları doğrultusunda kullanılabilir.







MONTAJ AÇIKLAMALARI

- / Montaj işleminden önce ürün nakliye hasarları yönünden kontrol edilmelidir. Montaj işleminden sonra nakliye veya yüzey hasarları için sorumluluk üstlenilmemektedir.
- / Boruların ve armatürün montajı, yıkanması ve kontrolü geçerli normlara göre yapılmalıdır.
- / Ülkelerde geçerli kurulum yönetmeliklerine riayet edilmelidir.
- / Kanal gerilimsiz bir şekilde döşenmelidir!
- / İşlev kontrolü (bakınız sayfa 19) Şekil 8
- / Sızdırmazlık kontrolü (bakınız sayfa 19) Şekil 9
- / 58316000, 58316820, 58316930, 58312000, 58312820, 58312930: Yığılma elemanı (plastik adaptör) kullanılarak banyo küvetinin maksimum dolm yüksekliği yaklaşık 25 mm yükseltilebilir. Besleme hattının taşma kapasitesinden daha büyük olmadığı kontrol edilmelidir.

TEKNİK BİLGİLER

Çıkış gücü:	64 l/dak
taşma kapasitesi:	42 l/dak

SİMGE AÇIKLAMASI

-  Asetik asit içeren silikon kullanmayın!
-  ÖLÇÜLERİ (bakınız sayfa 17)
-  YEDEK PARÇALAR (bakınız sayfa 23)
-  TEMİZLEME (bakınız sayfa 24)
-  KULLANIMI (bakınız sayfa 22)
-  KONTROL İŞARETİ (bakınız sayfa 22)

MONTAJI (bakınız sayfa 18) 

Δ INSTRUȚIUNI DE SIGURANȚĂ

- Δ La montare utilizați mănuși pentru evitarea contuziunilor și tăierii mâinilor.
- Δ Produsul poate fi utilizat doar pentru spălarea, menținerea igienei și curățarea corpului.







INSTRUCȚIUNI DE MONTARE

- / Înainte de instalare verificați, dacă produsul prezintă deteriorări de transport. După instalare garanția nu acoperă deteriorările de transport și cele de suprafață.
- / Conductele și bateriile trebuie montate, spălate și verificate conform normelor în vigoare.
- / Respectați reglementările referitoare la instalare valabile în țara respectivă.
- / Conducta de scurgere trebuie amplasată fără tensionare!
- / Verificarea funcționării (vezi pag. 19) Fig. 8
- / Verificarea etanșeității (vezi pag. 19) Fig. 9
- / 58316000, 58316820, 58316930, 58312000, 58312820, 58312930: Prin utilizarea elementului de blocare (element din material plastic) puteți să măriti înălțimea maximă a apei în cada de baie cu cca. 25 mm. Verificați ca debitul de intrare să nu fie mai mare decât debitul deversorului!

DATE TEHNICE

Capacitate de evacuare: 64 l/min
debit deversor: 42 l/min

DESCRIEREA SIMBOLURILOR

-  Nu utilizați silicon cu conținut de acid acetic!
-  DIMENSIUNI (vezi pag. 17)
-  PIESE DE SCHIMB (vezi pag. 23)
-  CURĂȚARE (vezi pag. 24)
-  UTILIZARE (vezi pag. 22)
-  CERTIFICAT DE TESTARE (vezi pag. 22)

Δ ΥΠΟΔΕΙΞΕΙΣ ΑΣΦΑΛΕΙΑΣ

- Δ Για να αποφύγετε τραυματισμούς κατά τη συναρμολόγηση πρέπει να φοράτε γάντια.
- Δ Το προϊόν επιτρέπεται να χρησιμοποιείται μόνο σαν μέσο λουτρού, υγιεινής και καθαρισμού του σώματος.







ΟΔΗΓΙΕΣ ΣΥΝΑΡΜΟΛΟΓΗΣΗΣ

- / Πριν τη συναρμολόγηση πρέπει να εξεταστεί το προϊόν για ζημιές μεταφοράς. Μετά την εγκατάσταση δεν αναγνωρίζονται ζημιές από τη μεταφορά ή επιφανειακές ζημιές.
- / Οι σωλήνες και η μπαταρία πρέπει να τοποθετηθούν σύμφωνα με τα ισχύοντα πρότυπα, να τεθούν υπό πίεση και να δοκιμαστούν.
- / Θα πρέπει να τηρούνται οι οδηγίες εγκατάστασης που ισχύουν σε κάθε κράτος.
- / Η βαλβίδα εκροής δεν πρέπει να υποβάλλεται σε τάσεις!
- / Έλεγχος λειτουργίας (βλ. Σελίδα 19) εικ. 8
- / Έλεγχος στεγανότητας (βλ. Σελίδα 19) εικ. 9
- / 58316000, 58316820, 58316930, 58312000, 58312820, 58312930: Η χρήση του βοηθητικού στοιχείου (πλαστική προσθήκη) μπορεί να αυξήσει το μέγιστο ύψος πλήρωσης της μπιανέρας κατά περ. 25 mm. Θα πρέπει να ελέγχεται εάν η εισερχόμενη ροή νερού είναι μεγαλύτερη από την ροή υπερχειλίσης!

ΤΕΧΝΙΚΑ ΧΑΡΑΚΤΗΡΙΣΤΙΚΑ

Απόδοση απορροής: 64 l/min
ροή υπερχειλίσης: 42 l/min

ΠΕΡΙΓΡΑΦΗ ΣΥΜΒΟΛΩΝ

-  Μην χρησιμοποιείτε σιλικόνη που περιέχει οξέλι οξύ!
-  ΔΙΑΣΤΑΣΕΙΣ (βλ. Σελίδα 17)
-  ΑΝΤΑΛΛΑΚΤΙΚΑ (βλ. Σελίδα 23)
-  ΚΑΘΑΡΙΣΜΟΣ (βλ. Σελίδα 24)
-  ΧΕΙΡΙΣΜΟΣ (βλ. Σελίδα 22)
-  ΣΗΜΑ ΕΛΕΓΧΟΥ (βλ. Σελίδα 22)



△ VARNOSTNA OPOZORILA

- △ Pri montaži je treba nositi rokavice, da se preprečijo poškodbe zaradi zmečkanja ali urezov.
- △ Ta izdelek se sme uporabljati le z namenom umivanja, vzdrževanja higiene in telesne nege.







NAVODILA ZA MONTAŽO

- / Pred montažo je treba izdelek preveriti glede morebitnih transportnih poškodb. Po vgradnji transportne ali površinske poškodbe ne bodo več priznane.
- / Cevi in armaturo je treba montirati, izprati in preveriti po veljavnih standardih.
- / Upoštevatı je treba pravilnike o inštalacijah, ki veljajo v posamezni državi.
- / Odtok je treba speljati brez napetosti!
- / Funkcijsko preizkušanje (glejte stran 19) Sl. 8
- / Preverjanje tesnenja. (glejte stran 19) Sl. 9
- / 58316000, 58316820, 58316930, 58312000, 58312820, 58312930: Z uporabo zajezitvenega elementa (plastičnega vložka) lahko maksimalno višino vode v kadi povišate za ca. 25 mm. Preveriti morate, da zmogljivost dotoka ni večja od zmogljivosti preliva!

TEHNIČNI PODATKI

Odtočna zmogljivost:	64 l/min
zogljivost preliva:	42 l/min

OPIS SIMBOLA

-  Ne smete uporabiti silikona, ki vsebuje ocetno kislino!
-  MERE (glejte stran 17)
-  REZERVNI DELI (glejte stran 23)
-  ČIŠČENJE (glejte stran 24)
-  UPRAVLJANJE (glejte stran 22)
-  PRESKUSNI ZNAK (glejte stran 22)

△ OHUTUSJUHISED

- △ Kandke paigaldamisel muljumis- ja lõikevigastuste vältimiseks kindaid.
- △ Toodet tohib kasutada ainult pesemis-, hügieeni- ja kehahupastamiseesmärkidel.







PAIGALDAMISJUHISED

- / Enne paigaldamist tuleb toodet kontrollida transporti- kahjustuste osas Pärast paigaldamist ei tunnustata enam transporti- või pinnakahjustuste kaebuseid.
- / Voolukute ja segisti paigaldamisel, loputamisel ja kontrollimisel tuleb lähtuda kehtivatest normatiividest
- / Vastavas riigis kehtivaid paigalduseeskirju tuleb järgida.
- / Äravool peab olema paigutatud pingevaltl!
- / Funktsiooni kontroll (vt lk 19) Joonis 8
- / Lekkekontroll (vt lk 19) Joonis 9
- / 58316000, 58316820, 58316930, 58312000, 58312820, 58312930: Veetõkkelemendi rakendamisel (kunstmaterjal) saab vanni maksimaalset täituvuskõrgust ca 25 mm võrra tõsta. Jälgige, et juurdevool ei ületaks ülevoolu!

TEHNILISED ANDMED

Äravooluvõimsus:	64 l/min
ülevool:	42 l/min

SÜMBOLITE KIRJELDUS

-  Ärge kasutage äädikhapet sisaldavat silikoonil!
-  MÕÕTUDE (vt lk 17)
-  VARUOSAD (vt lk 23)
-  PUHASTAMINE (vt lk 24)
-  KASUTAMINE (vt lk 22)
-  KONTROLLSERTIFIKAAT (vt lk 22)

△ DROŠĪBAS NORĀDES

- △ Montāžas laikā, lai izvairītos no saspiedumiem un iegrīzumiem, nepieciešams nēsāt cimdus.
- △ Šo produktu drīkst izmantot tikai, lai mazgātos, higiēnai un ķermeņa tīrīšanai.







NORĀDĪJUMI MONTĀŽAI

- / Pirms montāžas nepieciešams pārbaudīt, vai produktam transportēšanas laikā nav radušies bojājumi. Pēc iebūvēšanas bojājumi, kas radušies transportēšanas laikā, vai virsmas bojājumi netiek atzīti.
- / Caurulvadi un armatūra ir jāuzstāda, jāizskalo un jāpārbauda saskaņā ar spēkā esošajiem standartiem.
- / Jāievēro attiecīgās valstīs spēkā esošās montāžas prasības.
- / Notece ir jānovieto bez sprieguma!
- / Funkcionalitātes pārbaude (skat. lpp. 19) Att. 8
- / Hermetizācijas pārbaude (skat. lpp. 19) Att. 9
- / 58316000, 58316820, 58316930, 58312000, 58312820, 58312930: Izmantojot aizsprosta elementu (sintētisks ieliktnis), var paaugstināt maksimālo piepildīšanas augstumu vannā apm. par 25 mm. Jāpārbauda, lai iepilūdes jauda nepārsniegtu pārplūdes jaudu.

TEHNISKIE DATI

Aizplūdes iespējas:	64 l/min
pārplūdes ierīces jauda:	42 l/min

SIMBOLU NOZĪME

-  Neizmantot silikonu, kas satur etiķskābi!
-  IZMĒRUS (skat. lpp. 17)
-  REZERVES DAĻAS (skat. lpp. 23)
-  TĪRĪŠANA (skat. lpp. 24)
-  LIETOŠANA (skat. lpp. 22)
-  PĀRBAUDES ZĪME (skat. lpp. 22)

△ SIGURNOSNE NAPOMENE

- △ Prikļom montāžē se radi sprečavanja prignječenja i posekotina moraju nositi rukavice.
- △ Proizvod sme da se koristi samo za kupanje, tuširanje i ličnu higijenu.







INSTRUKCIJE ZA MONTAŽU

- / Pre montāžē se mora proveriti da li je proizvod oštećen pri transportu. Nakon ugradnje se ne priznaju nikakve reklamacije koje se odnose na površinska i transportna oštećenja.
- / Vodovi i armatura moraju biti postavljeni, isprani i testirani prema važećim normama.
- / Treba se pridržavati propisa koji u određenim zemljama važe za instalacije.
- / Odvod se mora tako položiti da ne bude izložen naprezanju!
- / Provera funkcionisanja (vidi stranu 19) Sl. 8
- / Provera zaptivenosti (vidi stranu 19) Sl. 9
- / 58316000, 58316820, 58316930, 58312000, 58312820, 58312930: Upotrebom plastičnog umetka, nivo vode u kadi može se povećati za oko 25 mm. Pritom treba paziti da količina vode nije veća od kapaciteta kade!

TEHNIČKI PODACI

Kapacitet odvoda:	64 l/min
kapacitet kade:	42 l/min

OPIS SIMBOLA

-  Nemojte koristiti silikon koji sadrži sirćetnu kiselinu!
-  MERE (vidi stranu 17)
-  REZERVNI DELOVI (vidi stranu 23)
-  ČIŠĆENJE (vidi stranu 24)
-  RUKOVANJE (vidi stranu 22)
-  ISPITNI ZNAK (vidi stranu 22)

⚠ SIKKERHETSHENVISNINGER

- ⚠ Bruk hansker under montasjen for å unngå klem- og kuttskader.
- ⚠ Produktet skal kun brukes for bade-, hygiene- og kroppshygiene.







MONTAGEHENVISNINGER

- / Før montasjen skal produktet sjekkes for transportskader. Etter monteringen aksepteres ikke noen transport- eller overflateskader.
- / Ledningene og armaturen skal monteres, spyles og sjekkes iht. de gyldige normer.
- / Gjeldende retningslinjer for rørleggerarbeid i de enkelte land skal følges.
- / Avløpet skal installeres spenningsfritt!
- / Funksjonskontroll (se side 19) Bilde 8
- / Pakningssjekk (se side 19) Bilde 9
- / 58316000, 58316820, 58316930, 58312000, 58312820, 58312930: Ved hjelp av oppdemmings-elementet (plastinnsats) er det mulig å øke karetts maksimale fyllhøyde med 25 mm. Man må sjekke at den maksimale vanntilførselen ikke er større enn overflytkapasitet!

TEKNISKE DATA

Avløpskapasitet:	64 l/min
overflyttingsfunksjon:	42 l/min

SYMBOLBESKRIVELSE

-  Ikke bruk silikon som inneholder eddiksyre!
-  MÅL (se side 17)
-  SERVICEDELER (se side 23)
-  RENGJØRING (se side 24)
-  BETJENING (se side 22)
-  PRØVEMERKE (se side 22)



⚠ УКАЗАНИЯ ЗА БЕЗОПАСНОСТ

- ⚠ При монтажа трябва да се носят ръкавици, за да се избегнат наранявания поради притискане или порязване.
- ⚠ Позволено е използването на продукта само за къпане, хигиена и цели на почистване на тялото.







УКАЗАНИЯ ЗА МОНТАЖ

- / Преди монтажа продуктът трябва да се провери за транспортни щети. След монтажа не се признават транспортни или повърхностни щети.
- / Тръбопроводите и арматурата трябва да се монтира, промият и проверят в съответствие с валидните норми.
- / Трябва да бъдат спазвани валидните в съответните страни предписания за инсталиране.
- / Отвеждането трябва да се полага без напрежение!
- / Функционална проверка (вижте стр. 19) фиг. 8
- / Проверка на плътността (вижте стр. 19) фиг. 9
- / 58316000, 58316820, 58316930, 58312000, 58312820, 58312930: Като се използва подпирания елемент (пластмасова вложка) максималната височина на пълнене на ваната може да се повиши с около 25 mm. Трябва да се провери, дали мощността на захранване не е по-голяма от преливната мощност!

ТЕХНИЧЕСКИ ДАННИ

Мощност на изтичане:	64 л/мин
мощност на преливане:	42 л/мин

ОПИСАНИЕ НА СИМВОЛИТЕ

-  Не използвайте силикон, съдържащ оцетна киселина!
-  РАЗМЕРИ (вижте стр. 17)
-  СЕРВИЗНИ ЧАСТИ (вижте стр. 23)
-  ПОЧИСТВАНЕ (вижте стр. 24)
-  ОБСЛУЖВАНЕ (вижте стр. 22)
-  КОНТРОЛЕН ЗНАК (вижте стр. 22)



△ UDHËZIME SIGURIE

- △ Për të evituar lëndimet e pickimeve ose të prerjeve gjatë procesit të montimit duhet që të vishni doreza.
- △ Produkti duhet të përdoret vetëm qëllimet e banjave, të higjienës dhe të larjes së trupit.







UDHËZIME PËR MONTIMIN

- / Përpara montimit duhet që produkti të kontrollohet për dëmtime nga transporti. Pas instalimit nuk do të njihet asnjë dëmtim nga transporti ose dëmtim i sipërfaqes.
- / Tubacionet dhe rubinetet duhet që të montohen, të shpëlahen dhe të kontrollohen sipas standardeve në fuqi
- / Duhet të respektohen linjat udhëzuese të instalimit, të vlefshme për vendet respektive.
- / Dalja duhet montuar pa tension!
- / Kontrolli i funksioneve (shih faqen 19) Fig. 8
- / Kontrolli se a rrjedh diku ujë (shih faqen 19) Fig. 9
- / 58316000, 58316820, 58316930, 58312000, 58312820, 58312930: Me përdorimin e elementit për evitimin e qarkullimit (kapaku plastik) mund të rritet mbushja maksimale e vaskës edhe për 25 mm. Duhet kontrolluar që kapaciteti i hyrjes të mos jetë më i lartë se kapaciteti i vendrrjedhjes së ujit të tepërt!

TË DHËNA TEKNIKE

Shkarkimi në dalje: 64 l/min
kapaciteti i vendrrjedhjes së ujit të tepërt: 42 l/min

PËRSHKRIMI I SIMBOLIT

-  Mos përdorni silikon që në përbërje ka acid acetik.
-  PËRMASAT (shih faqen 17)
-  PJESËT E SERVISIT (shih faqen 23)
-  PASTRIMI (shih faqen 24)
-  PËRDORIMI (shih faqen 22)
-  SHENJA E KONTROLLIT (shih faqen 22)

△ تنبيهات الأمان

- △ يجب ارتداء قفازات لليد أثناء التركيب لتجنب حدوث أخطار الإنحشار أو الجروح.
- △ لا يجب استخدام المنتج إلا في أغراض الاستحمام والأغراض الصحية وأغراض تنظيف الجسم.







تعليمات التركيب

- / قبل القيام بعملية التركيب، يجب فحص المنتج للتأكد من خلوه من أية تلفيات ناتجة عن النقل. بعد القيام بعملية التركيب، لن يتم الاعتراف بوجود أية تلفيات سطحية أو تلفيات ناتجة عن عملية النقل.
- / يجب تركيب وغسيل واختبار التوصيلات وخلطات المياه طبقاً للمعايير السارية.
- / يجب مراعاة القواعد الخاصة بالتركيب وأعمال السباكة وفقاً للوائح الخاصة بكل بلد.
- / يجب تركيب الصرف بدون أي شد من أح الأطراف!
- / إختبار الوظيفة (راجع صفحة 19) انظر الصورة رقم 8
- / إختيار التسريب (راجع صفحة 19) انظر الصورة رقم 9
- / 58312000, 58316930, 58316820, 58316000 / 58312930, 58312820: عن طريق استخدام وحدة الحاجز (حاجز بلاستيكي)، يمكن زيادة الحد الأقصى لارتفاع المياه في حوض الاستحمام إلى 25 مم. ومع ذلك، قد يتطلب الأمر التأكد من أن مقدار المياه لا يتجاوز سعة حوض الاستحمام.

المواصفات الفنية

قدرة تسيير: 64 لتر / الدقيقة
سعة حوض الاستحمام: 42 لتر / الدقيقة

وصف الرمز

-  هام! لا تستخدم السليكون الذي يحتوي على أحماض!
-  أبعاد (راجع صفحة 17)
-  قطع الغيار (راجع صفحة 23)
-  التنظيف (راجع صفحة 24)
-  التشغيل (راجع صفحة 22)
-  شهادة اختبار (راجع صفحة 22)



⚠ BIZTONSÁGI UTASÍTÁSOK

- ⚠ A szerelésnél a zúzódások és vágási sérülések elkerülése érdekében kesztyűt kell viselni.
- ⚠ A terméket csak fürdéshez, mosakodáshoz, és egészségügyi tisztálkodáshoz szabad használni.







SZERELÉSI UTASÍTÁSOK

- / A szerelés előtt ellenőrizni kell, hogy a terméknek nincs-e szállítási sérülése. Beépítés után a szállítási- vagy felületi sérüléseket nem ismerik el.
- / A vezetékeket és a csapterlepet az érvényes szabványoknak megfelelően kell felszerelni, öblíteni és ellenőrizni
- / Az egyes országokban érvényes installációs irányelveket be kell tartani.
- / A lefolyót feszülés mentesen kell lerakni!
- / Működés ellenőrzése (lásd a oldalon 19) ábra 8
- / Tömítési próba (lásd a oldalon 19) ábra 9
- / 58316000, 58316820, 58316930, 58312000, 58312820, 58312930: A gátelem (műanyagbetét) segítségével a kád maximális töltési magassága kb. 25 mm-el megemelhető. Ellenőrizni kell, hogy a befolyó teljesítmény nem nagyobb, mint a túlfolyó teljesítmény!

MŰSZAKI ADATOK

Lefolyási teljesítmény:	64 l/perc
túlfolyó teljesítmény:	42 l/perc

SZIMBÓLUMOK LEÍRÁSA

-  Ne használjon ecetsavtartalmú szilikont!
-  MÉRLETET (lásd a oldalon 17)
-  TARTOZÉKOK (lásd a oldalon 23)
-  TISZTÍTÁS (lásd a oldalon 24)
-  HASZNÁLAT (lásd a oldalon 22)
-  VIZSGAJEL (lásd a oldalon 22)





AXOR Flexaplust
58313180

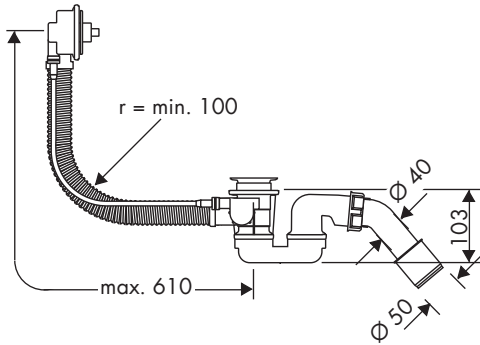

AXOR Flexaplust
58314180

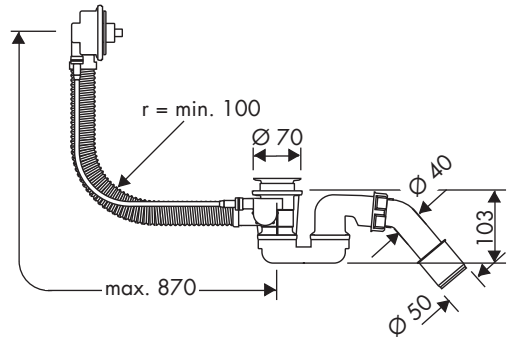

AXOR Flexaplust
58315000

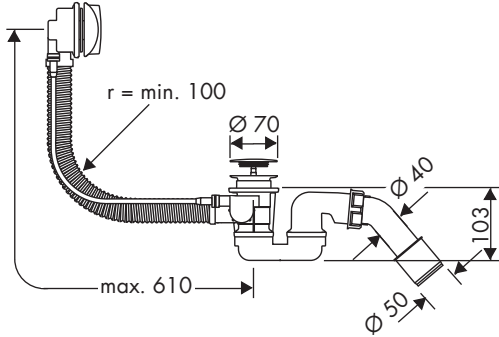

AXOR Flexaplust S
58312000 / 58312820 / 58312930

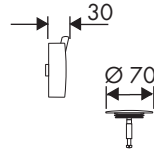

AXOR Flexaplust S
58316000 / 58316820 / 58316930

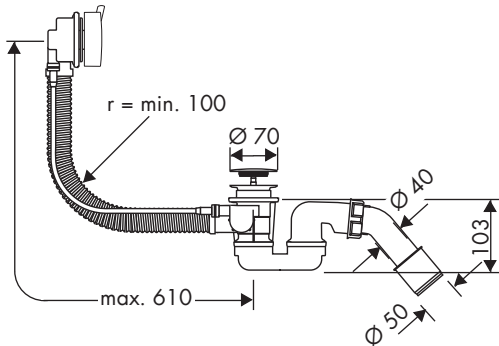

AXOR Flexaplust
58311000

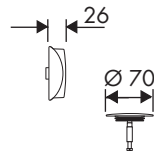

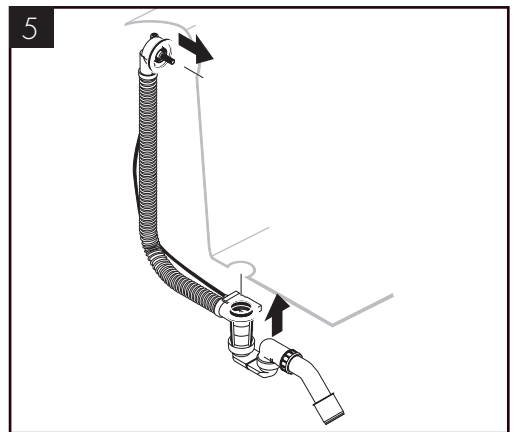
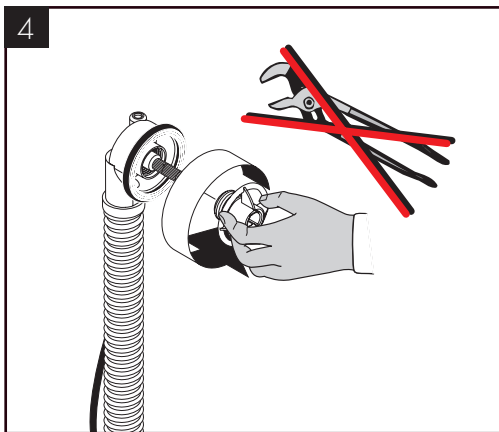
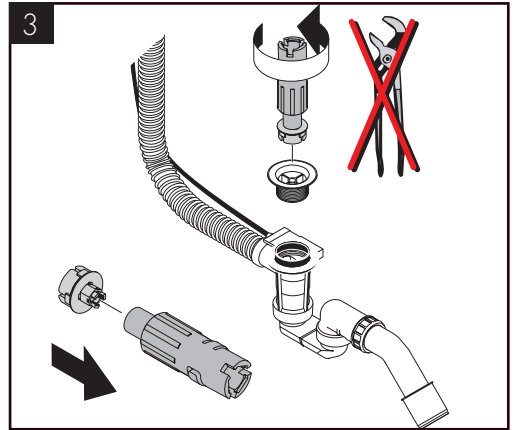
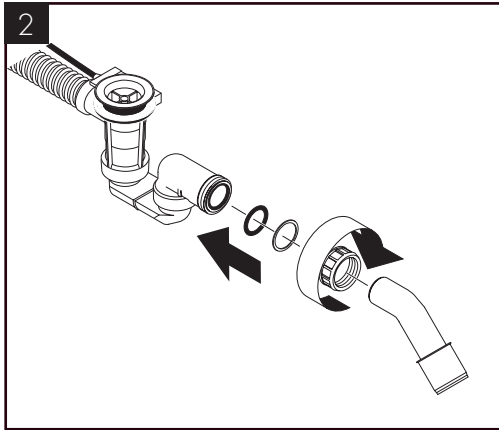
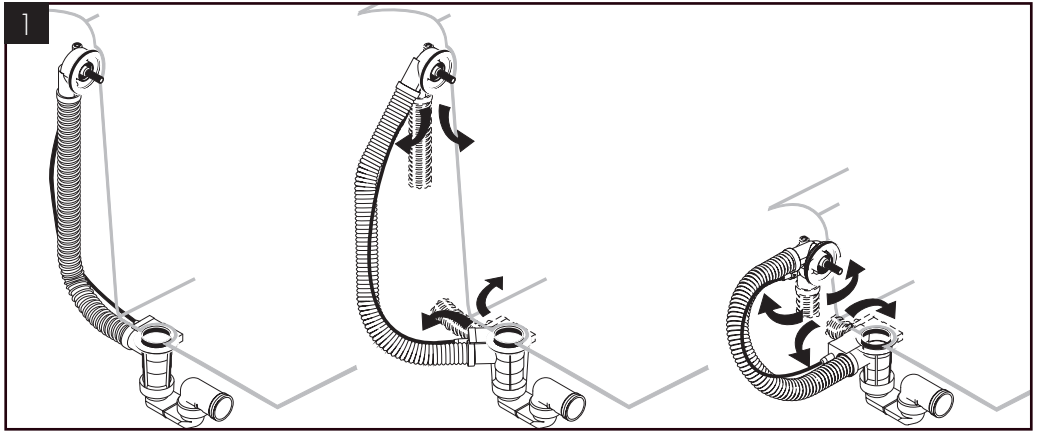

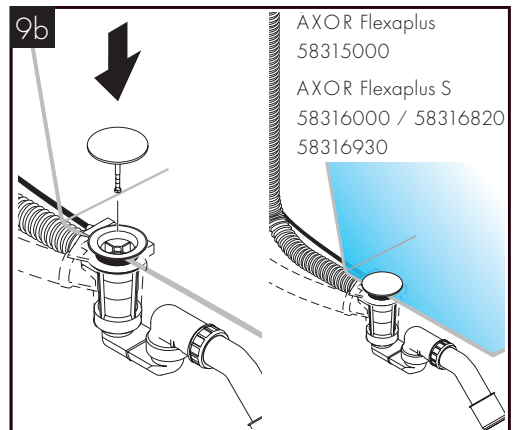
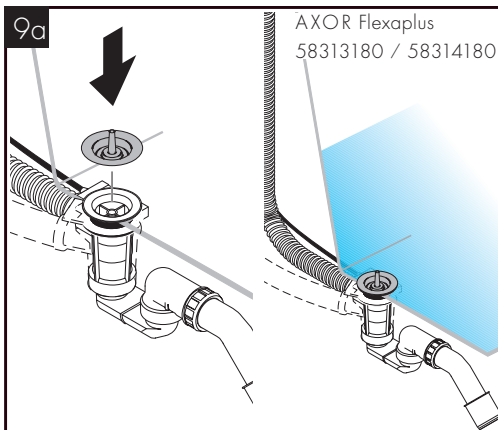
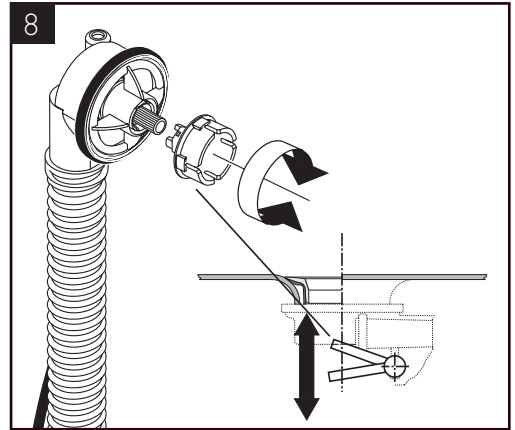
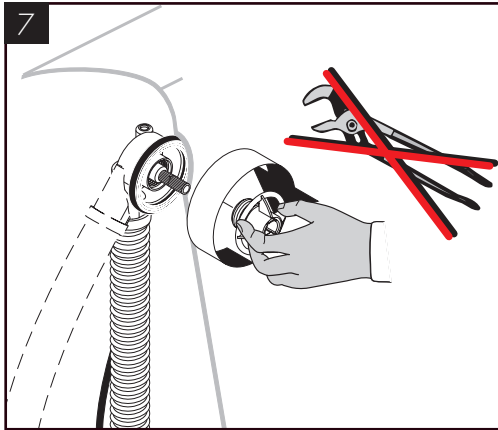
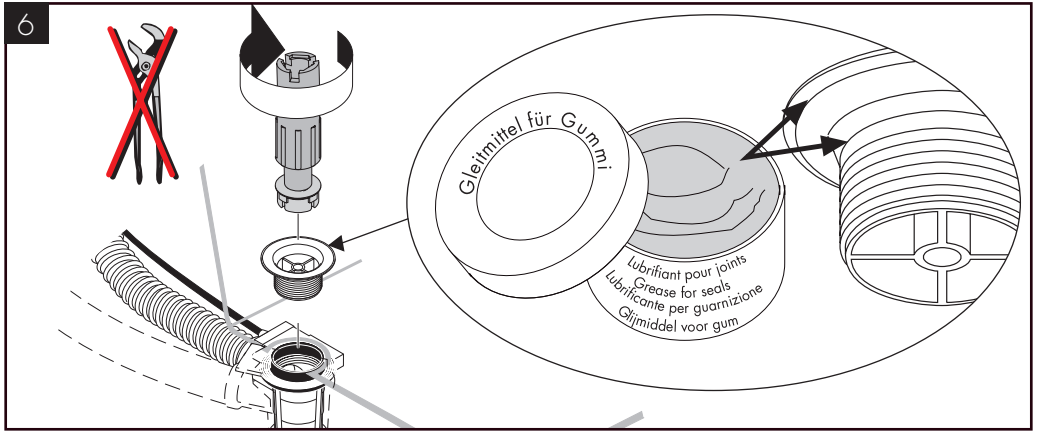

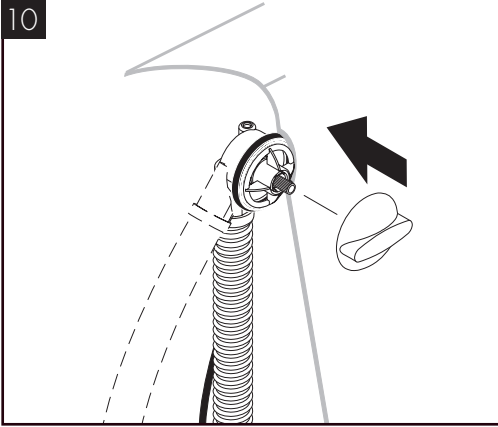

58316000/58316820/58316930/58312000/58312820/58312930

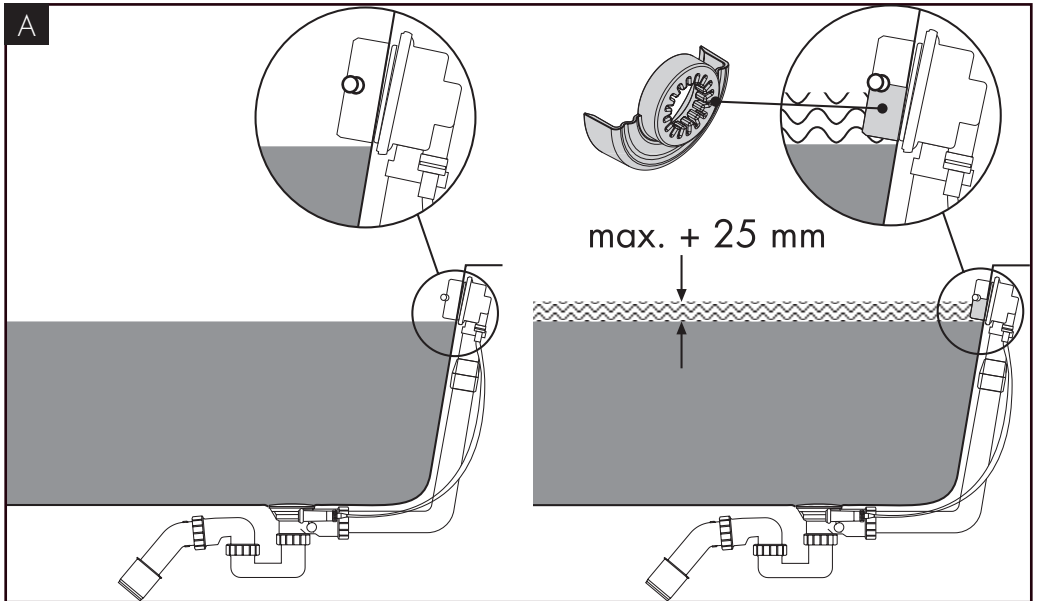



58316000/58316820/58316930/58312000/58312820/58312930

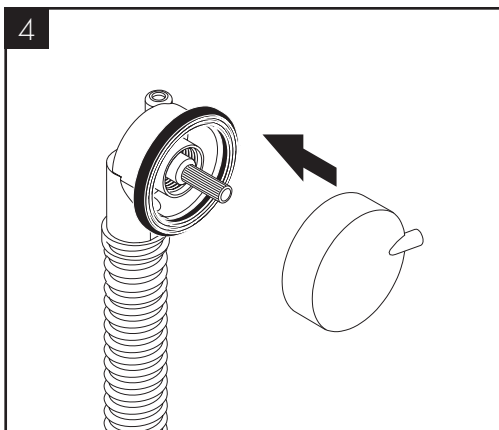
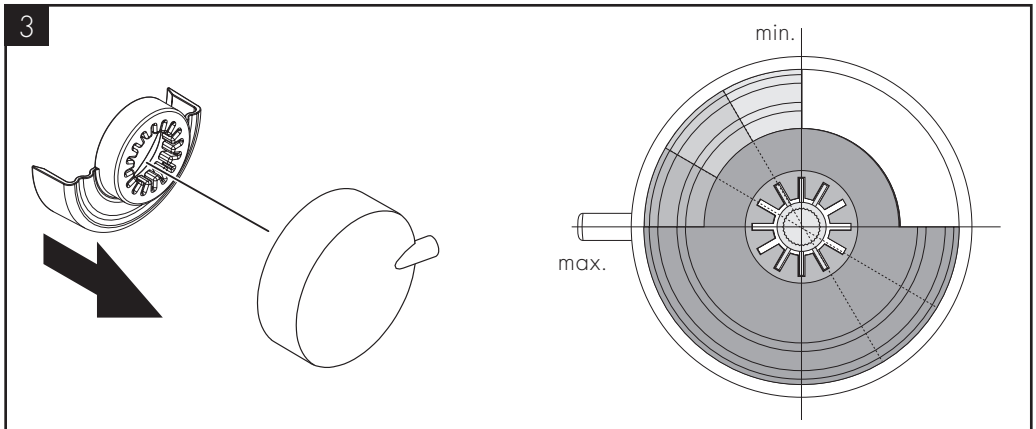
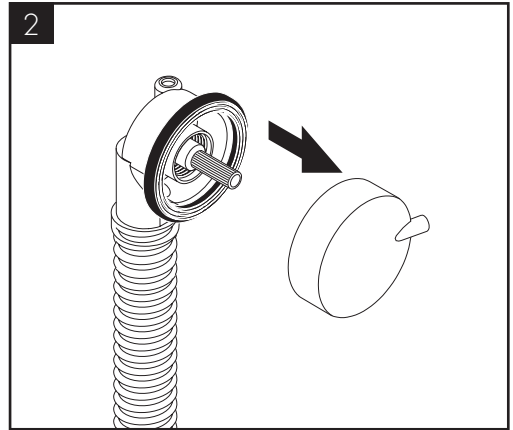
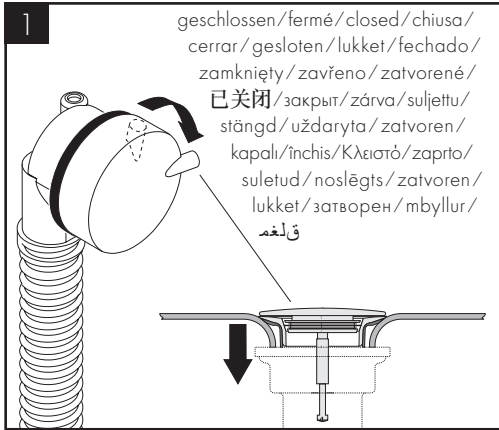

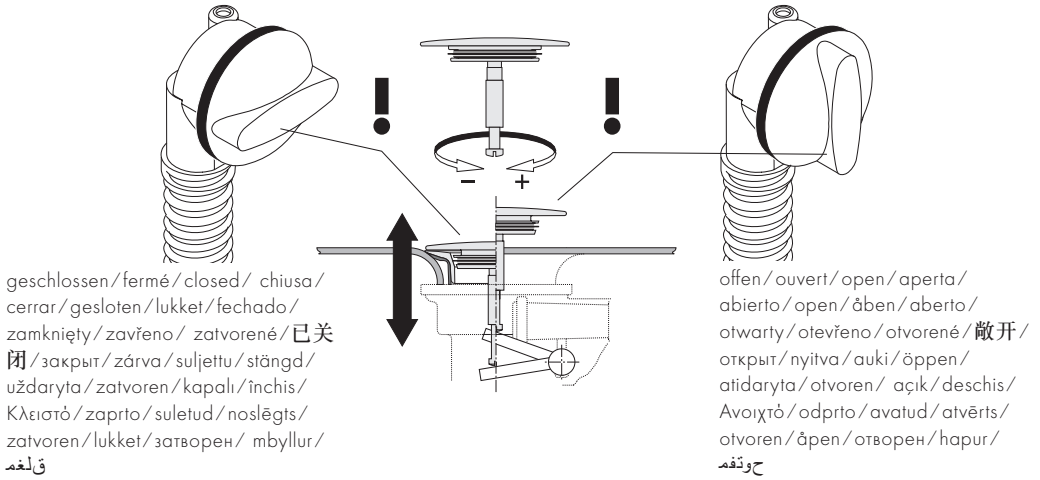

	DVGW	SVGW	KIWA	WRAS	NF	ACS
58313180					X	
58314180					X	
58315000						
58316000/ 58316820/ 58316930						
58311000						
58312000/ 58312820/ 58312930						



AXOR Flexaplus
58313180 / 58314180 /
58315000

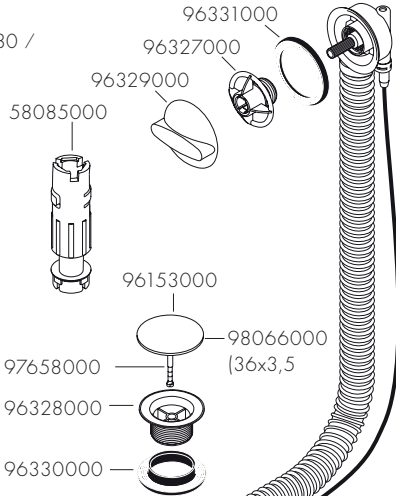

AXOR Flexaplus
58311000

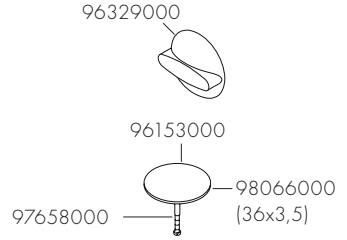

AXOR Flexaplus S
58316000 / 58316820 /
58316930

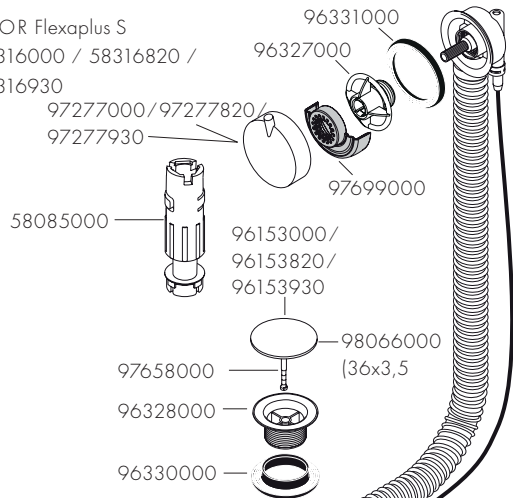

AXOR Flexaplus S
58312000 / 58312820 /
58312930

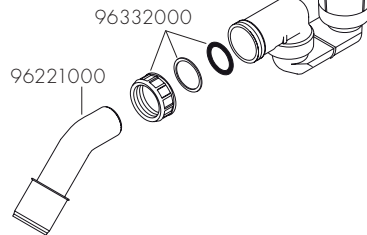
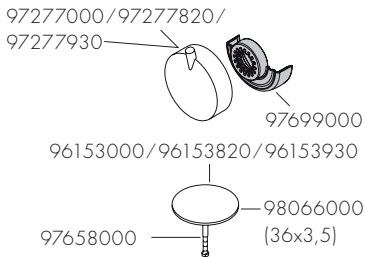



- DE / Reinigungsempfehlung / Garantie / Kontakt
 FR / Recommandation pour le nettoyage / Garanties / Contact
 EN / Cleaning recommendation / Warranty / Contact
 IT / Raccomandazione di pulizia / Garanzia / Contatto
 ES / Recomendaciones para la limpieza / Garantía / Contacto
 NL / Aanbevelingen inzake reiniging / Garantie / Contact
 DK / Rensning, anbefaling / Garanti / Kontakt
 PT / Recomendações de limpeza / Garantia / Contacto
 PL / Zalecenie dotyczące pielęgnacji / Gwarancja / Kontakt
 CS / Doporučení k čištění / Záruka / Kontakt
 SK / Odporúčania pre čistenie / Záruka / Kontakt
 ZH / 清洁指南 / 担保 / 接触
 RU / Рекомендации по очистке / Гарантия / Контакты
 HU / Tisztítási tanácsok / Garancia / érintkezés
 FI / Puhdistussuositus / Takuu / Kosketus
 SV / Rengöringsrekommendationer / Garanti / Contacto
 LT / Valymo rekomendacijos / Garantija / Kontaktai
 HR / Preporuke za čišćenje / Garancija / Kontakt
 TR / Temizleme önerisi / Garanti / Temas
 RO / Recomandări pentru curățare / Garanție / Contact
 EL / Σύσταση καθαρισμού / Εγγύηση / επαφή
 SL / Priporočilo za čišćenje / Garancija / Kontakt
 ET / Puhastussuovitused / Garantii / Kontakt
 LV / Tīrīšanas ieteikumi / Garantija / Kontakti
 SR / Preporuke za čišćenje / Garancija / Kontakt
 NO / Anbefaling for rengjøring / Garanti / Kontakt
 BG / Препоръка за почистване / Гаранция / Контакт
 SQ / Këshilla rreth pastrimit / Garancia / Kontakt
 KO / 세정시 권장사항 / 품질보증 / 접촉
 AR / توصيات التنظيف / الضمان (الولايات المتحدة الأمريكية) / اتصال



[www.axor-design.com/
cleaning-recommendation](http://www.axor-design.com/cleaning-recommendation)

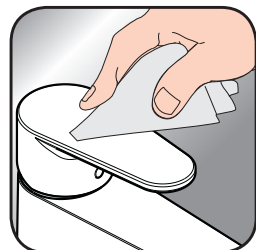

[www.axor-design.com/
cleaning-recommendation](http://www.axor-design.com/cleaning-recommendation)



[www.axor-design.com/
cleaning-recommendation](http://www.axor-design.com/cleaning-recommendation)



[www.axor-design.com/
cleaning-recommendation](http://www.axor-design.com/cleaning-recommendation)

AXOR

AXOR / Hansgrohe SE
Austraße 5-9
77761 Schiltach
Deutschland

info@axor-design.com
axor-design.com

04/2019
918085.01