



**UNIDOMO®**

**Web:** [www.unidomo.de](http://www.unidomo.de)

**Telefon:** 04621- 30 60 89 0

**Mail:** [info@unidomo.com](mailto:info@unidomo.com)

**Öffnungszeiten:** Mo.-Fr. 8:00-17:00 Uhr

**VIESSMANN**

**Buderus**

 **Vaillant**

**WOLF**

 **JUNKERS**  **BOSCH**



 **remeha**



 **DAIKIN**

**ROTEX**

a member of DAIKIN group



-  Individuelle Beratung
-  Kostenloser Versand
-  Hochwertige Produkte

-  Komplettpakete
-  Über 15 Jahre Erfahrung
-  Markenhersteller

# AXOR

DE / Gebrauchsanleitung / Montageanleitung	02
FR / Mode d'emploi / Instructions de montage	02
EN / Instructions for use / assembly instructions	03
IT / Istruzioni per l'uso / Istruzioni per l'installazione	03
ES / Modo de empleo / Instrucciones de montaje	04
NL / Gebruiksaanwijzing / Handleiding	04
DK / Brugsanvisning / Monteringsvejledning	05
PT / Instruções para uso / Manual de instalação	05
PL / Instrukcja obsługi / Instrukcja montażu	06
CS / Návod k použití / Montážní návod	06
SK / Návod na použitie / Montážny návod	07
ZH / 用户手册 / 组装说明	07
RU / Руководство пользователя / Инструкция по монтажу	08
HU / Használati útmutató / Szerelési útmutató	08
FI / Käyttöohje / Asennusohje	09
SV / Bruksanvisning / Monteringsanvisning	09
LT / Vartotojo instrukcija / Montavimo instrukcijos	10
HR / Upute za uporabu / Uputstva za instalaciju	10
TR / Kullanım kılavuzu / Montaj kılavuzu	11
RO / Manual de utilizare / Instrucțiuni de montare	11
EL / Οδηγίες χρήσης / Οδηγία συναρμολόγησης	12
SL / Navodilo za uporabo / Navodila za montažo	12
ET / Kasutusjuhend / Paigaldusjuhend	13
LV / Lietošanas pamācība / Montāžas instrukcija	13
SR / Uputstvo za upotrebu / Uputstvo za montažu	14
NO / Bruksanvisning / Montasjeveiledning	14
BG / Инструкция за употреба / Ръководство за монтаж	15
SQ / Udhëzuesi i përdorimit / Udhëzime rreth montimit	15
AR / دليل الاستخدام / تعليمات التجميع	16

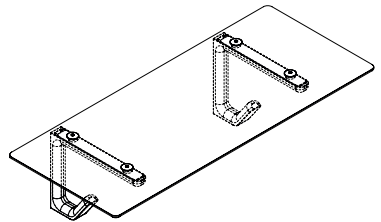

AXOR Universal Accessoire  
4284XXX

INSTALLATION







### ⚠ SICHERHEITSHINWEISE

- ⚠ Bei der Montage müssen zur Vermeidung von Quetsch- und Schnittverletzungen Handschuhe getragen werden.
- ⚠ Die ordnungsgemäße Befestigung und der feste Sitz der montierten Produkte ist in periodischen Abständen (jährlich) zu überprüfen.

### MONTAGEHINWEISE

- / Vor der Montage muss das Produkt auf Transportschäden untersucht werden.  
Nach dem Einbau werden keine Transport- oder Oberflächenschäden anerkannt.
- / Bei der Montage des Produktes durch qualifiziertes Fachpersonal ist darauf zu achten, dass die Befestigungsfläche im gesamten Bereich der Befestigung plan ist (keine vorstehenden Fugen oder Fliesenversatz), der Wandaufbau für eine Montage des Produktes geeignet ist und keine Schwachstellen aufweist.

### SYMBOLERKLÄRUNG

-  Kein essigsäurehaltiges Silikon verwenden!
-  MASSE  
(siehe Seite 20)
-  SERVICETEILE  
(siehe Seite 18)
-  REINIGUNG  
(siehe Seite 19)
-  Durch die Exzenterbuchse können Bohrtoleranzen ausgeglichen werden.  
(siehe Seite 17)
-  PRÜFZEICHEN  
(siehe Seite 18)

MONTAGE (siehe Seite 17) 







### ⚠ CONSIGNES DE SÉCURITÉ

- ⚠ Lors du montage, porter des gants de protection pour éviter toute blessure par écrasement ou coupure.
- ⚠ Vérifier à intervalles réguliers (une fois par an) la fixation correcte et la bonne assise des produits montés

### INSTRUCTIONS POUR LE MONTAGE

- / Avant son montage, s'assurer que le produit n'a subi aucun dommage pendant le transport  
Après le montage, tout dommage de transport ou de surface ne pourra pas être reconnu.
- / Lors du montage de ce produit par du personnel qualifié, veiller à ce que la surface de fixation soit bien plane dans toute la zone de fixation (pas de dépassement de joints ou de déport de carreaux), à ce que le mur se prête au montage du produit et ne présente aucun point fragile.

### DESCRIPTION DU SYMBOLE

-  Ne pas utiliser de silicone contenant de l'acide acétique!
-  DIMENSIONS  
(voir pages 20)
-  PIÈCES DÉTACHÉES  
(voir pages 18)
-  NETTOYAGE  
(voir pages 19)
-  Grâce à l'axe excentrique de réglage on peut rattraper la tolérance de perçage.  
(voir pages 17)
-  CLASSIFICATION  
(voir pages 18)

MONTAGE (voir pages 17) 

### ⚠ SAFETY NOTES

- ⚠ Gloves should be worn during installation to prevent crushing and cutting injuries.
- ⚠ Check the proper attachment and tight seating of the installed products periodically (annually).

### INSTALLATION INSTRUCTIONS

- / Prior to installation, inspect the product for transport damages. After it has been installed, no transport or surface damage will be honoured.
- / During installation of the product by qualified trained personnel, make sure that the entire fastening surface is even and smooth (no protruding seams or tile offset), that the finish of the wall is suitable to apply the product and has no weak points.

### ⚠ INDICAZIONI SULLA SICUREZZA

- ⚠ Durante il montaggio, per evitare ferite da schiacciamento e da taglio bisogna indossare guanti protettivi.
- ⚠ Il fissaggio a regola d'arte e la sede fissa dei prodotti montati va controllato a intervallo periodico (annualmente).

### ISTRUZIONI PER IL MONTAGGIO

- / Prima del montaggio è necessario controllare che non ci siano stati danni durante il trasporto. Una volta eseguito il montaggio, non verranno riconosciuti eventuali danni di trasporto o delle superfici.
- / Per il montaggio del prodotto da personale specializzato qualificato bisogna fare attenzione, che la superficie di fissaggio, in tutto il campo di fissaggio, sia piana (nessuna giunzione sporgente o sfalsamento di piastrella), la costruzione della parete sia adatta al montaggio del prodotto e che non presenti alcun punto debole.

### SYMBOL DESCRIPTION

 Do not use silicone containing acetic acid!

 DIMENSIONS  
(see page 20)

 SPARE PARTS  
(see page 18)

 CLEANING  
(see page 19)

 With the excentric washer it is possible to equalize tolerance of the drilling.  
(see page 17)

 TEST CERTIFICATE  
(see page 18)

### DESCRIZIONE SIMBOLO

 Non utilizzare silicone contenente acido acetico!

 INGOMBRI  
(vedi pagg. 20)

 PARTI DI RICAMBIO  
(vedi pagg. 18)

 PULITURA  
(vedi pagg. 19)

 Con la rondella eccentrica è possibile equilibrare tolleranze diverse tra i fori.  
(vedi pagg. 17)

 SEGNO DI VERIFICA  
(vedi pagg. 18)

ASSEMBLY (see page 17) 

MONTAGGIO (vedi pagg. 17) 

## △ INDICACIONES DE SEGURIDAD

- △ Durante el montaje deben utilizarse guantes para evitar heridas por aplastamiento o corte.
- △ Debe comprobarse en intervalos periódicos (anualmente) que los productos montados estén bien fijados y asentados.

## INDICACIONES PARA EL MONTAJE

- / Antes del montaje se debe examinarse el producto contra daños de transporte. Después de la instalación no se reconoce ningún daño de transporte o de superficie.
- / Durante el montaje del producto, mediante personal especializado, se debe asegurar de que la superficie de sujeción en todo el área de la fijación sea plana (sin fugas o azulejos que sobresalgan), que la estructura del muro sea adecuada para el montaje del producto y que no presente puntos débiles.

## △ VEILIGHEIDSIINSTRUCTIES

- △ Bij de montage moeten ter voorkoming van knel- en snijwonden handschoenen worden gedragen.
- △ De reglementaire bevestiging en de vaste zitting van de gemonteerde producten moet regelmatig (jaarlijks) gecontroleerd worden.

## MONTAGE-INSTRUCTIES

- / Vóór de montage moet het product gecontroleerd worden op transport schade. Na de inbouw wordt geen transport- of oppervlakte-schade meer aanvaard.
- / Bij de montage van het product door gekwalificeerd vakpersoneel moet erop gelet worden dat het montagevlak in het volledige bereik van de bevestiging vlak is (geen uitstekende voegen of verspringende tegels), dat de wand geschikt is voor de montage van het product en geen zwakke plaatsen vertoont.

## DESCRIPCIÓN DE SÍMBOLOS



No utilizar silicona que contiene ácido acético!



**DIMENSIONES**  
(ver página 20)



**REPUESTOS**  
(ver página 18)



**LIMPIAR**  
(ver página 19)



Durante la instalación y mediante la excéntrica se puede corregir la posición de la barra.  
(ver página 17)



**MARCA DE VERIFICACIÓN**  
(ver página 18)

## SYMBOOLBESCHRIJVING



Gebruik geen zuurhoudende siliconen!



**MATEN**  
(zie blz. 20)



**SERVICE ONDERDELEN**  
(zie blz. 18)



**REINIGEN**  
(zie blz. 19)



Door de excentrische bus kunnen eventuele boorafwijkingen worden hersteld.  
(zie blz. 17)



**KEURMERK**  
(zie blz. 18)

MONTAJE (ver página 17) 

MONTAGE (zie blz. 17) 

## △ SIKKERHEDSANVISNINGER

- △ Ved monteringen skal der bruges handsker for at undgå kvæstelser og snitsår.
- △ Den korrekte montering og position af monterede produkter skal kontrolleres i regelmæssige afstande (årligt).

## MONTERINGSANVISNINGER

- / Før monteringen skal produktet kontrolleres for transportskader. Efter monteringen godkendes transportskader eller skader på overfladen ikke længere.
- / Ved montering af produktet igennem kvalificerede fagfolk skal der holdes øje med, at fastgørelsesoverfladen er plan i alle områder hvor produktet monteres (ingen fremragende fuger eller fliseforskydninger), at væggene er velegnet til monteringen af produktet og ikke har svare områder.

## △ AVISOS DE SEGURANÇA

- △ Durante a montagem devem ser utilizadas luvas de protecção, de modo a evitar ferimentos resultantes de entalamentos e de cortes.
- △ A fixação e encaixe correctos dos produtos montados devem ser verificados periodicamente (anualmente).







## AVISOS DE MONTAGEM

- / Antes da montagem deve-se controlar o produto relativamente a danos de transporte. Após a montagem não são aceites quaisquer danos de transporte ou de superfície.
- / Durante a montagem efectuada por técnicos qualificados deve ter-se em atenção que a superfície de fixação seja plana em toda a sua extensão (sem juntas ou ladrilhos salientes), que a estrutura da parede seja adequada para a montagem do produto e que não apresente pontos fracos.

## SYMBOLBESKRIVELSE

-  Der må ikke benyttes eddikesyreholdig silikone!
-  MÅLENE  
(se s. 20)
-  RESERVEDELE  
(se s. 18)
-  RENGØRING  
(se s. 19)
-  Ved hjælp af den excentriske bøsning kan evt. skævheder i borehullerne udlignes.  
(se s. 17)
-  GODKENDELSE  
(se s. 18)

## DESCRIÇÃO DO SÍMBOLO

-  Não utilizar silicone que contenha ácido acético!
-  MEDIDAS  
(ver página 20)
-  PEÇAS DE SUBSTITUIÇÃO  
(ver página 18)
-  LIMPEZA  
(ver página 19)
-  Com o encaixe excêntrico é possível compensar a tolerância da furação.  
(ver página 17)
-  MARCA DE CONTROLO  
(ver página 18)

## ⚠ WSKAZÓWKI BEZPIECZEŃSTWA

- ⚠ Aby uniknąć zranień, takich jak zgniecenia czy przecięcia, podczas montażu należy nosić rękawice.
- ⚠ W określonym czasie (co roku) należy sprawdzać właściwe zamocowanie i odpowiednie osadzenie zamontowanych produktów.

## WSKAZÓWKI MONTAŻOWE

- / Przed montażem należy skontrolować produkt pod kątem szkód transportowych.  
Po montażu nie widać żadnych szkód transportowych ani szkód na powierzchni.
- / Montaż produktu musi być wykonany przez wykwalifikowanego fachowca. Powierzchnia w miejscu montażu musi być równa (bez uskoków wzgl. wzajemnie przesuniętych płytek). Ściana w miejscu montażu musi być stabilna. Dołożone w komplecie śruby i kołki rozporowe są przeznaczone do betonu.

## OPIS SYMBOLU

-  Nie stosować silikonów zawierających kwas octowy!
-  WYMIARY  
(patrz strona 20)
-  CZĘŚCI SERWISOWE  
(patrz strona 18)
-  CZYSZCZENIE  
(patrz strona 19)
-  Za pomocą tulei mimośrodowej można łatwo wyrównać tolerancje otworów.  
(patrz strona 17)
-  ZNAK JAKOŚCI  
(patrz strona 18)

MONTAŻ (patrz strona 17) 







## ⚠ BEZPEČNOSTNÍ POKYNY

- ⚠ Pro zabránění řezným zraněním a pohmožděninám je nutné při montáži nosit rukavice.
- ⚠ Upevnění podle předpisů a pevné usazení montovaných produktů je třeba kontrolovat v periodických časových intervalech (ročně).

## POKYNY K MONTÁŽI

- / Před montáží je třeba produkt zkontrolovat, zda nebyl při transportu poškozen.  
Po zabudování nebudou uznány žádné škody způsobené transportem nebo poškození povrchu.
- / Při montáži produktu kvalifikovanou osobou je třeba dbát na to, aby byla upevňovací plocha v celé oblasti upevnění rovná (žádné vyčnívající spáry nebo zapuštění obkladů), aby struktura stěny byla vhodná pro montáž produktu a neměla žádná slabá místa.

## POPIS SYMBOLŮ

-  Nepoužívat silikon s obsahem kyseliny octové!
-  ROZMĚRY  
(viz strana 20)
-  SERVISNÍ DÍLY  
(viz strana 18)
-  ČIŠTĚNÍ  
(viz strana 19)
-  Excentrickými vložkami je možné vyrovnat tolerance vrtaných otvorů.  
(viz strana 17)
-  ZKUŠEBNÍ ZNAČKA  
(viz strana 18)

MONTÁŽ (viz strana 17) 

## △ BEZPEČNOSTNÉ POKYNY

- △ Pri montáži musíte nosiť rukavice, aby ste predišli pomliaždeninám a rezným poraneniam.
- △ Upevnenie podľa predpisov a pevné osadenie montovaných produktov treba kontrolovať v periodických časových intervaloch (ročne).

## POKYNY PRE MONTÁŽ

- / Pred montážou musíte produkt skontrolovať, či nebol počas transportu poškodený. Po zabudovaní nebudú uznané žiadne škody spôsobené transportom alebo poškodenia povrchu.
- / Pri montáži produktu kvalifikovanou osobou treba dávať pozor na to, aby bola upevňovacia plocha v celej oblasti upevnenia rovná (žiadne vyčnievajúce medzery alebo zapustenia obkladov), aby štruktúra steny bola vhodná pre montáž produktu a nemá žiadne slabé miesta.

## △ 安全技巧

- △ 装配时为避免挤压和切割受伤，必须戴上手套。
- △ 应定期（每年）检查已装配好的产品是否正常固定和固定定位。

## 安装提示

- / 安装前必须检查产品是否受到运输损害。安装后将不认可运输损害或表面损伤。
- / 由有资格的专业人员进行产品安装时请注意：在所有加固区域中，加固表面是否平整（无突出的接缝或瓷砖），墙体结构是否适合产品安装且未显露出任何缺点。

## POPIS SYMBOLOV



Nepoužívať silikón s obsahom kyseliny octovej!



ROZMERY  
(viď strana 20)



SERVISNÉ DIELY  
(viď strana 18)



ČISTENIE  
(viď strana 19)



Excentrickými vložkami je možné vyrovnat' toleranciu vŕtaných otvorov.  
(viď strana 17)



OSVEDČENIE O SKÚŠKE  
(viď strana 18)

## 符号说明



请勿使用含有乙酸的硅！



大小  
(参见第 20 页)



备用零件  
(参见第 18 页)



清洗  
(参见第 19 页)



用偏心套管可以补偿消除钻孔的偏差。  
(参见第 17 页)



检验标记  
(参见第 18 页)

MONTÁŽ (viď strana 17) 

安装 (参见第 17 页) 







## △ УКАЗАНИЯ ПО ТЕХНИКЕ БЕЗОПАСНОСТИ

- △ Во время монтажа следует надеть перчатки во избежание прищемления и порезов.
- △ Надлежащее крепление и плотность посадки установленных изделий следует проверять регулярно (ежегодно).

## УКАЗАНИЯ ПО МОНТАЖУ

- / Перед монтажом следует проверить изделие на предмет повреждений при перевозке. После монтажа претензии о возмещении ущерба за повреждения при перевозке или повреждении поверхностей не принимаются.
- / Во время монтажа изделия квалифицированным персоналом поверхность крепления должна быть ровной по всей области крепления (не допускайте выступающих стыков или перекоса облицовочной плитки); для монтажа изделия следует использовать подходящую стену достаточной прочности.

## ОПИСАНИЕ СИМВОЛОВ

-  Не применяйте силикон, содержащий уксусную кислоту.
-  **РАЗМЕРЫ**  
(см. стр. 20)
-  **КОМПЛЕКТ**  
(см. стр. 18)
-  **ОЧИСТКА**  
(см. стр. 19)
-  С помощью соединения-эксцентрика можно установить штангу строго вертикально.  
(см. стр. 17)
-  **ЗНАК ТЕХНИЧЕСКОГО КОНТРОЛЯ** (см. стр. 18)

МОНТАЖ (см. стр. 17)



## △ BIZTONSÁGI UTASÍTÁSOK

- △ A szerelésnél a zúzódások és vágási sérülések elkerülése érdekében kesztyűt kell viselni.
- △ A felszerelt termékek szabályszerű rögzítését és szilárd elhelyezkedését rendszeres időközönként (évente) ellenőrizni kell.

## SZERELÉSI UTASÍTÁSOK

- / A szerelés előtt ellenőrizni kell, hogy a terméknek nincs-e szállítási sérülése. Beépítés után a szállítási- vagy felületi sérüléseket nem ismerik el.
- / A termék képzett szakember általi felszerelése esetén ügyelni kell arra, hogy a rögzítési felület teljesen sima legyen (ne legyen kiálló fuga vagy csempe), a fal szerkezete a termék felszerelésére alkalmas legyen, és ne legyen gyenge pontja.

## SZIMBÓLUMOK LEÍRÁSA

-  Ne használjon ecetsavtartalmú szilikont!
-  **MÉRETET**  
(lásd a oldalon 20)
-  **TARTOZÉKOK**  
(lásd a oldalon 18)
-  **TISZTÍTÁS**  
(lásd a oldalon 19)
-  Az excenter hüvelynek köszönhetően a fűrési egyenletlenségek kiegyenlíthetőek.  
(lásd a oldalon 17)
-  **VIZSGAJEL**  
(lásd a oldalon 18)

SZERELÉS (lásd a oldalon 17)



## △ TURVALLISUUSOHJEET

- △ Asennuksessa on käytettävä käsiineitä puristumien ja viiltojen aiheuttamien tapaturmien estämiseksi.
- △ Asennettujen tuotteiden asianmukainen kiinnitys ja tiukkuus on tarkastettava säännöllisin väliajoin (vuosittain).

## A SENNUSOHJEET

- / Ennen asennusta on tarkastettava tuotteen mahdolliset kuljetusvahingot. Asennuksen jälkeen kuljetus- ja pintavaurioita ei hyväksytä.
- / Pätevän ammattihenkilöstön asentaessa tuotetta on otettava huomioon, että kiinnityspinnan on oltava koko kiinnitysalueelta tasainen (ei korkeita saumoja tai laatojen yhtymäkohtia), seinän rakenne soveltuu tuotteen asennukseen eikä siinä ole heikkoja kohtia.

## △ SÄKERHETSANVISNINGAR

- △ Handskar ska bäras under monteringsarbetet så att man kan undvika kläm- och skärskadorgen werden.
- △ Alla monterade produkter ska kontrolleras regelbundet (varje år) så att de sitter fast ordentligt.







## M ONTERINGSANVISNINGAR

- / Det måste undersökas om produkten har transportskador innan den monteras. Efter monteringen accepteras inga transport- eller ytskiktsskador.
- / När kvalificerad fackpersonal monterar produkten är det viktigt att fästyten är plan över hela fastsättningsområdet (inga fogar som sticker ut eller kakelförskjutning) och att väggstrukturen är lämplig för en montering av produkten och inte har några svaga punkter.

## MERKIN KUVAUS

-  Älä käytä etikkahappopitoista silikoniala.
-  MITAT  
(katso sivu 20)
-  VARAOSAT  
(katso sivu 18)
-  PUHDISTUS  
(katso sivu 19)
-  Poraustoleranssit voidaan tasata epäkeskokeilla.  
(katso sivu 17)
-  KOESTUSMERKKI  
(katso sivu 18)

## S YMBOLFÖRKLARING

-  Använd inte silikon som innehåller ättiksyra!
-  MÅTTEN  
(se sidan 20)
-  RESERVDELAR  
(se sidan 18)
-  RENGÖRING  
(se sidan 19)
-  Borrtoleranser kan utjämnas genom excenterhylsan.  
(se sidan 17)
-  TESTSIGILL  
(se sidan 18)

A SENNUS (katso sivu 17) 

M ONTERING (se sidan 17) 







## ⚠ SAUGUMO TECHNIKOS NURODYMAI

- ⚠ Apsaugai nuo užspaudimo ir įsijovimo montavimo metu mūvėkite pirštines.
- ⚠ Gaminių pritvirtinimo teisingumą ir patikimumą būtina periodiškai (kasmet) tikrinti.

## MONTAVIMO INSTRUKCIJA

- / Prieš montuojant būtina patikrinti, ar gaminys nebuvo pažeistas transportavimo metu. Sumontavus pretenzijos dėl transportavimo ir paviršiaus pažeidimų nepriimamos.
- / Atlikdami montavimo darbus, kvalifikuoti darbuotojai turi atkreipti dėmesį, kad pritvirtinimo plokštuma būtų lygi (be išsikišusių siūlių ar perkreiptų plytelių), sienų konstrukcija tiktų gaminiui montuoti ir neturėtų jokių trūkumų.

## SIMBOLIO APRAŠYMAS

-  Nenaudokite silikono, kurio sudėtyje yra acto rūgšties!
-  IŠMATAVIMAI  
(žr. psl. 20)
-  ATSARGINĖS DALYS  
(žr. psl. 18)
-  VALYMAS  
(žr. psl. 19)
-  Ekscentrinės jungties pagalba galima išlyginti išgręžtų angų nuokrypį.  
(žr. psl. 17)
-  BANDYMO PAŽYMA  
(žr. psl. 18)

MONTAVIMAS (žr. psl. 17) 

## ⚠ SIGURNOSNE UPUTE

- ⚠ Prilikom montaže se radi sprječavanja prignječenja i posjekotina moraju nositi rukavice.
- ⚠ U redovitim vremenskim razmacima (jednom godišnje) valja provjeravati propisnu pričvršćenost i stabilnost postavljenih proizvoda.

## UPUTE ZA MONTAŽU

- / Prije montaže mora se provjeriti je li proizvod oštećen prilikom transporta. Nakon ugradnje se ne priznaju nikakve reklamacije koje se odnose na površinska i transportna oštećenja.
- / Kada proizvod montira kvalificirano stručno osoblje treba paziti da čitava površina na koju se učvršćuje bude ravna (bez istaknutih fuga ili krivljenja pločica), da je zidna konstrukcija primjerena montaži proizvoda te da nema slabih mjesta.

## OPIS SIMBOLA

-  Nemojte koristiti silikon koji sadrži octenu kiselinu!
-  MJERE  
(pogledaj stranicu 20)
-  REZERVNI DJELOVI  
(pogledaj stranicu 18)
-  ČIŠĆENJE  
(pogledaj stranicu 19)
-  Pomoću ekscentara mogu se podesiti tolerancije prvrtva.  
(pogledaj stranicu 17)
-  OZNAKA TESTIRANJA  
(pogledaj stranicu 18)

SASTAVLJANJE (pogledaj stranicu 17) 

### △ GÜVENLİK UYARILARI

- △ Montaj esnasında ezilme ve kesilme gibi yaralanmaları önlemek için eldiven kullanılmalıdır.
- △ Monte edilmiş ürünlerin talimatlara uygun sabitliği ve sıkı duruşu düzenli aralıklarla (yıllık) kontrol edilmelidir.

### MONTAJ AÇIKLAMALARI

- / Montaj işleminden önce ürün nakliye hasarları yönünden kontrol edilmelidir.  
Montaj işleminden sonra nakliye veya yüzey hasarları için sorumluluk üstlenilmemektedir.
- / Ürünün yetkili uzman personel tarafından montajı yapılırken, sabitleme yüzeyinin sabitleme planının tüm alanında bulunduğu (derz veya fayans kayması olmamalıdır), duvar yapısının ürünün montajı için uygun olduğuna ve zayıf noktaları bulunmadığına dikkat edilmelidir.

### △ INSTRUCȚIUNI DE SIGURANȚĂ

- △ La montare utilizați mănuși pentru evitarea contuziunilor și tăierii mâinilor.
- △ Fixarea corespunzătoare și poziția fixă a produselor montate trebuie verificate la intervale regulate (anual).

### INSTRUCȚIUNI DE MONTARE

- / Înainte de instalare verificați, dacă produsul prezintă deteriorări de transport.  
După instalare garanția nu acoperă deteriorările de transport și cele de suprafață.
- / La montarea produsului de către un personal calificat se va avea grijă ca suprafața de fixare să fie plană pe toată aria de fixare (fără proeminențe ale rosturilor sau îmbinări între plăcile de faianță) și ca structura peretelui să fie corespunzătoare pentru fixarea produsului, să nu prezinte locuri cu rezistență redusă.

### SİMGE AÇIKLAMASI

-  Asetik asit içeren silikon kullanmayın!
-  ÖLÇÜLERİ  
(bakınız sayfa 20)
-  YEDEK PARÇALAR  
(bakınız sayfa 18)
-  TEMİZLEME  
(bakınız sayfa 19)
-  Eksantrik burç ile delik toleransları dengelenebilir.  
(bakınız sayfa 17)
-  KONTROL İŞARETİ  
(bakınız sayfa 18)

### DESCRIEREA SIMBOLURILOR

-  Nu utilizați silicon cu conținut de acid acetic!
-  DIMENSIUNI  
(vezi pag. 20)
-  PIESE DE SCHIMB  
(vezi pag. 18)
-  CURĂȚARE  
(vezi pag. 19)
-  Compensați diferențele de găurit cu ajutorul bușei excentrice.  
(vezi pag. 17)
-  CERTIFICAT DE TESTARE  
(vezi pag. 18)

MONTAJI (bakınız sayfa 17) 

MONTARE (vezi pag. 17) 







**⚠ ΥΠΟΔΕΙΞΕΙΣ ΑΣΦΑΛΕΙΑΣ**

- ⚠ Για να αποφύγετε τραυματισμούς κατά τη συναρμολόγηση πρέπει να φοράτε γάντια.
- ⚠ Θα πρέπει να ελέγχετε ανά διαστήματα (ετησίως) αν η στερέωση εξακολουθεί να είναι επαρκής και αν τα τοποθετημένα προϊόντα στηρίζονται καλά.

**ΟΔΗΓΙΕΣ ΣΥΝΑΡΜΟΛΟΓΗΣΗΣ**

- / Πριν τη συναρμολόγηση πρέπει να εξεταστεί το προϊόν για ζημιές μεταφοράς. Μετά την εγκατάσταση δεν αναγνωρίζονται ζημιές από τη μεταφορά ή επιφανειακές ζημιές.
- / Κατά τη συναρμολόγηση του προϊόντος από ειδικό προσωπικό θα πρέπει να ελέγχεται με ιδιαίτερη προσοχή η επιφάνεια στερέωσης, αν είναι επίπεδη σε όλη της την επιφάνεια (δεν πρέπει να εξέχουν αρμοί ή πλακάκια), αν η υποδομή του τοίχου είναι κατάλληλη για τη στερέωση του προϊόντος και αν παρουσιάζει ασθενή σημεία.

**ΠΕΡΙΓΡΑΦΗ ΣΥΜΒΟΛΩΝ**

-  Μην χρησιμοποιείτε σιλικόνη που περιέχει οξικό οξύ!
-  ΔΙΑΣΤΑΣΕΙΣ  
(βλ. Σελίδα 20)
-  ΑΝΤΑΛΛΑΚΤΙΚΑ  
(βλ. Σελίδα 18)
-  ΚΑΘΑΡΙΣΜΟΣ  
(βλ. Σελίδα 19)
-  Μέσω του κουτιού του εκκέντρου είναι δυνατή η εξισορρόπηση των ανοχών διάτρησης.  
(βλ. Σελίδα 17)
-  ΣΗΜΑ ΕΛΕΓΧΟΥ  
(βλ. Σελίδα 18)







ΣΥΝΑΡΜΟΛΟΓΗΣΗ (βλ. Σελίδα 17) **⚠ VARNOSTNA OPOZORILA**

- ⚠ Pri montaži je treba nositi rokavice, da se preprečijo poškodbe zaradi zmečkanja ali urezov.
- ⚠ V periodičnih presledkih (letno) je treba preverjati pravično pritrditev in trdnost naseda montiranih proizvodov.

**NAVODILA ZA MONTAŽO**

- / Pred montažo je treba izdelek preveriti glede morebitnih transportnih poškodb. Po vgradnji transportne ali površinske poškodbe ne bodo več priznane.
- / Pri montaži tega proizvoda s strani kvalificiranega strokovnega osebja je treba paziti na to, da je pritrđilna ploskev na celotni površini za pritrđitev gladka (brez izstopajočih fug ali zasekov ploščic), da je struktura stene primerna za montažo proizvoda in ne kaže šibkih mest.

**OPIS SIMBOLA**

-  Ne smete uporabiti silikona, ki vsebuje ocatno kislino!
-  MERE  
(glejte stran 20)
-  REZERVNI DELI  
(glejte stran 18)
-  ČIŠČENJE  
(glejte stran 19)
-  Z ekscentričnim vodilom lahko izravnate tolerance vrtanja.  
(glejte stran 17)
-  PRESKUSNI ZNAK  
(glejte stran 18)

MONTAŽA (glejte stran 17) 

## △ OHUTUSJUHISED

- △ Kandke paigaldamisel muljumis- ja löikevigastuste vältimiseks kindaid.
- △ Monteeritud toote nõuetekohast paigaldust ja kinnitust tuleb korrapäraselt (kord aastas) kontrollida.

## PAIGALDAMISJUHISED

- / Enne paigaldamist tuleb toodet kontrollida transpordikahjustuste osas  
Pärast paigaldamist ei tunnustata enam transpordi- või pinnakahjustuste kaebuseid.
- / Toote paigaldamisel kvalifitseeritud spetsialistide poolt tuleb jälgida, et kinnituspind oleks kogu ulatuses ühtlaselt tasane (mitte ühtki üleseisvat vuuki või kaldus kahhelkivi), seina ülesehitus toote paigaldamiseks sobiv ja ilma nõrkade kohtadeta.

## △ DROŠĪBAS NORĀDES

- △ Montāžas laikā, lai izvairītos no saspiedumiem un iegriezumiem, nepieciešams nēsāt cimdus.
- △ Nepieciešams periodiski (reizi gadā) pārbaudīt, vai uzmontētie produkti ir pareizi piestiprināti un labi turas.







## NORĀDĪJUMI MONTĀŽAI

- / Pirms montāžas nepieciešams pārbaudīt, vai produktam transportēšanas laikā nav radušies bojājumi. Pēc iebūvēšanas bojājumi, kas radušies transportēšanas laikā, vai virsmas bojājumi netiek atzīti.
- / Kvalificētiem speciālistiem, montējot produktu, jāpiegriež vērība tam, lai piestiprināšanas virsma visā piestiprināšanas zonā ir gluda (nav fūgu vai flīžu iecirtumu), sienas uzbūve ir piemērota produkta montāžai un tajā nav nestabilu vietu.

## SŪMBOLITE KIRJELDUS

-  Ārge kasutage äädikhapet sisaldavat silikoonil
-  MÕÕTUDE  
(vt lk 20)
-  VARUOSAD  
(vt lk 18)
-  PUHASTAMINE  
(vt lk 19)
-  Ekstsentrilise vaheseibiga saab puurimisel tekkitud erinevusi tasakaalustada.  
(vt lk 17)
-  KONTROLLSERTIFIKAAT  
(vt lk 18)

## SIMBOLU NOZĪME

-  Neizmantoj silikonu, kas satur etiķskābi!
-  IZMĒRUS  
(skat. lpp. 20)
-  REZERVES DAĻAS  
(skat. lpp. 18)
-  TĪRĪŠANA  
(skat. lpp. 19)
-  Ar ekscentra bukses palīdzību var izlīdzināt urbuma neprecizitātes.  
(skat. lpp. 17)
-  PĀRBAUDES ZĪME  
(skat. lpp. 18)

PAIGALDAMINE (vt lk 17) 

MONTĀŽA (skat. lpp. 17) 

### ⚠ SIGURNOSNE NAPOMENE

- ⚠ Prilikom montaže se radi sprečavanja prignječenja i posekotina moraju nositi rukavice.
- ⚠ Propisna pričvršćenost i stabilnost postavljenih proizvoda treba redovno da se proverava (jednom godišnje).

### INSTRUKCIJE ZA MONTAŽU

- / Pre montaže se mora proveriti da li je proizvod oštećen pri transportu.  
Nakon ugradnje se ne priznaju nikakve reklamacije koje se odnose na površinska i transportna oštećenja.
- / Kada proizvod montira kvalifikovano stručno osoblje treba paziti da čitava površina na koju se učvršćuje bude ravna (bez istaknutih fuga ili krivljenja pločica), da je zidna konstrukcija primerena montaži proizvoda i da nema slabih mesta.

### OPIS SIMBOLA

 Nemojte koristiti silikon koji sadrži sircetnu kiselinu!

 MERE  
(vidi stranu 20)

 REZERVNI DELOVI  
(vidi stranu 18)

 ČIŠĆENJE  
(vidi stranu 19)

 Pomoću ekscentara mogu se podesiti tolerancije prvrtu.  
(vidi stranu 17)

 ISPITNI ZNAK  
(vidi stranu 18)

MONTAŽA (vidi stranu 17) 

### ⚠ SIKKERHETSHENVISNINGER

- ⚠ Bruk hansker under montasjen for å unngå klem- og kuttskader.
- ⚠ De monterte produktene skal regelmessig sjekkes om de er ordentlig festet og om de sitter fast.

### MONTAGEHENVISNINGER

- / Før montasjen skal produktet sjekkes for transportska-  
der.  
Etter monteringen aksepteres ikke noen transport- eller  
overflateskader.
- / Under monteringen av produktet gjort av kvalifisert  
fagpersonel, skal man påse at monteringsoverflaten  
på hele festeområdet er plant (ingen utstikkende fuger  
eller flisekanter), at veggoppbyggingen egner seg for  
produktmontasjen og ikke viser svake punkter.

### SYMBOLBESKRIVELSE

 Ikke bruk silikon som inneholder eddiksyrel!

 MÅL  
(se side 20)

 SERVICEDELER  
(se side 18)

 RENGJØRING  
(se side 19)

 Boretoleranser kan utlignes ved hjelp av eksen-  
terbassing.  
(se side 17)

 PRØVEMERKE  
(se side 18)

MONTASJE (se side 17) 

## △ УКАЗАНИЯ ЗА БЕЗОПАСНОСТ

- △ При монтажа трябва да се носят ръкавици, за да се избегнат наранявания поради притискане или порязване.
- △ Правилното закрепване и правилното разположение на монтираните продукти трябва да се проверява периодично (ежегодно).

## УКАЗАНИЯ ЗА МОНТАЖ

- / Преди монтажа продуктът трябва да се провери за транспортни щети.  
След монтажа не се признават транспортни или повърхностни щети.
- / При монтаж на продукта от квалифицирани специалисти да се внимава за това, закрепващата повърхност в целия диапазон на закрепването да бъде равна (без изпъкнали fugи или изместване на плочки), конструкцията на стената да е подходяща за монтаж на продукта и да няма слаби места.







## △ UDHËZIME SIGURIE

- △ Për të evituar lëndimet e pickimeve ose të prerjeve gjatë procesit të montimit duhet që të vishni doreza.
- △ Montimi dhe pozicioni sipas rregullave i produkteve të montuara duhet verifikuar periodikisht (një herë në vit).







## UDHËZIME PËR MONTIMIN

- / Përpára montimit duhet që produkti të kontrollohet për dëmtime nga transporti.  
Pas instalimit nuk do të njihet asnjë dëmtim nga transporti ose dëmtim i sipërfaqes.
- / Gjatë montimit të produktit nga teknikët e specializuar duhet mbajtur parasysh që sipërfaqja e montimit gjendet brenda zonës së përgjithshme të planit të montimit (nuk ka vendbashkime të dala ose mospërputhje të pllakave), që struktura e murit është e përshtatshme për montimin e produktit dhe që nuk paraqet asnjë pikë të dobët.

## ОПИСАНИЕ НА СИМВОЛИТЕ

-  Не използвайте силикон, съдържащ оцетна киселина!
-  **РАЗМЕРИ**  
(вижте стр. 20)
-  **СЕРВИЗНИ ЧАСТИ**  
(вижте стр. 18)
-  **ПОЧИСТВАНЕ**  
(вижте стр. 19)
-  Допуските при пробиване могат да се изравнят с ексцентричната вулка.  
(вижте стр. 17)
-  **КОНТРОЛЕН ЗНАК**  
(вижте стр. 18)

## PËRSHKRIMI I SIMBOLIT

-  Mos përdorni silikon që në përbërje ka acid acetik.
-  **PËRMASAT**  
(shih faqen 20)
-  **PJESËT E SERVISIT**  
(shih faqen 18)
-  **PASTRIMI**  
(shih faqen 19)
-  Përmes kutisë ekscentrike mund të ekuilibrohen tolerancat gjatë shpimit.  
(shih faqen 17)
-  **SHENJA E KONTROLLIT**  
(shih faqen 18)

МОНТАЖ (вижте стр. 17) 

МОНТИМИ (shih faqen 17) 



### ⚠ تنبيهات الأمان

⚠ يجب إرتداء قفازات لليد أثناء التركيب لتجنب حدوث أخطار الإنحشار أو الجروح.

⚠ يتعين التأكد من أن حالة التثبيت مطابقة للشروط المحددة والتأكد من الوضع الثابت للمنتجات المركبة على فترات منتظمة (سنوياً)

### تعليمات التركيب

- / قبل القيام بعملية التركيب، يجب فحص المنتج للتأكد من خلوه من أية تلفيات ناتجة عن النقل.
- بعد القيام بعملية التركيب، لن يتم الاعتراف بوجود أية تلفيات سطحية أو تلفيات ناتجة عن عملية النقل.
- / عند التركيب بواسطة عمال تركيب متخصصين يجب الإنتباه إلى أن مساحة التثبيت في مكان التركيب بوجه عام مسطحة (لا توجد روابط أو فروق للربط بين البلاطات). لذا يجب التأكد من أن الحائط الذي سيتم تركيب المنتج عليه صالح لذلك وأنه لا يوجد به نقاط ضعف.

### وصف الرمز

- هام! لا تستخدم السليكون الذي يحتوي على أحماض! 
- أبعاد  (راجع صفحة 20)
- قطع الغيار  (راجع صفحة 18)
- التنظيف  (راجع صفحة 19)
- باستخدام الحلقة اللامركزية يمكن معادلة خلوص الثقب.  (راجع صفحة 17)
- شهادة اختبار  (راجع صفحة 18)

 التركيب (راجع صفحة 17)

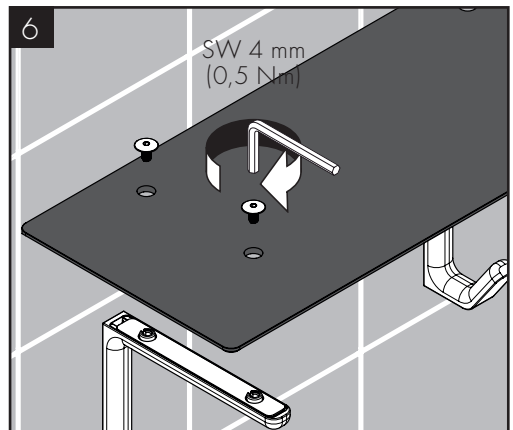
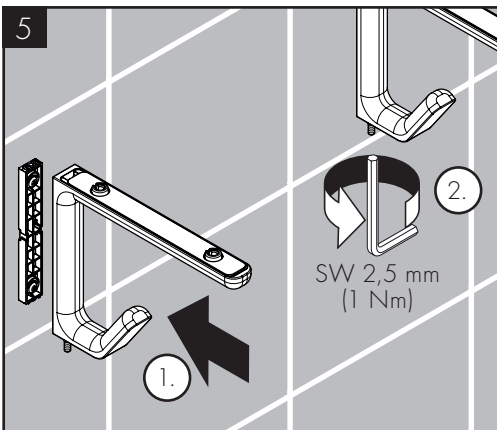
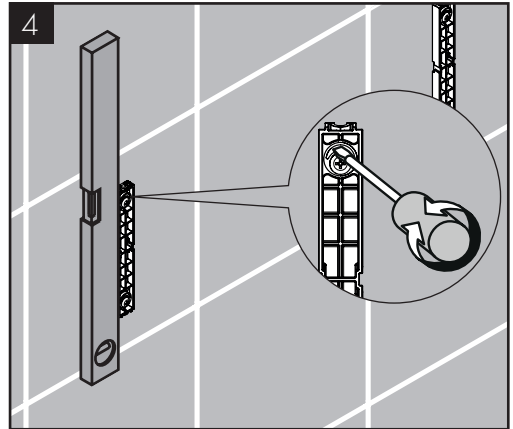
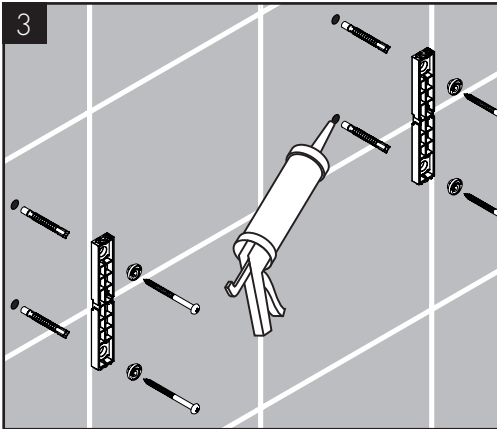
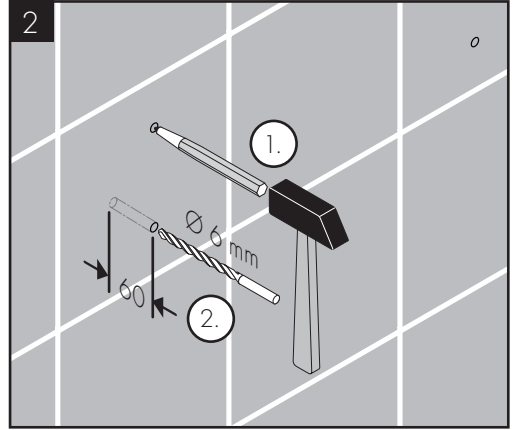
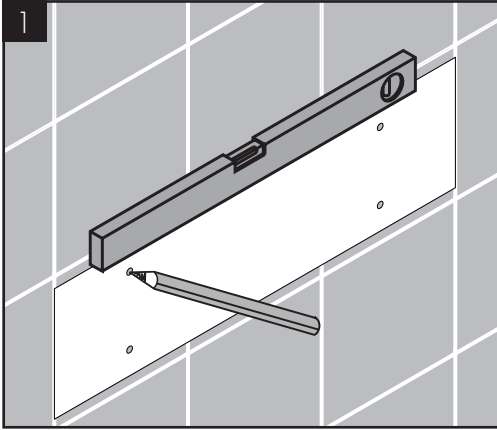

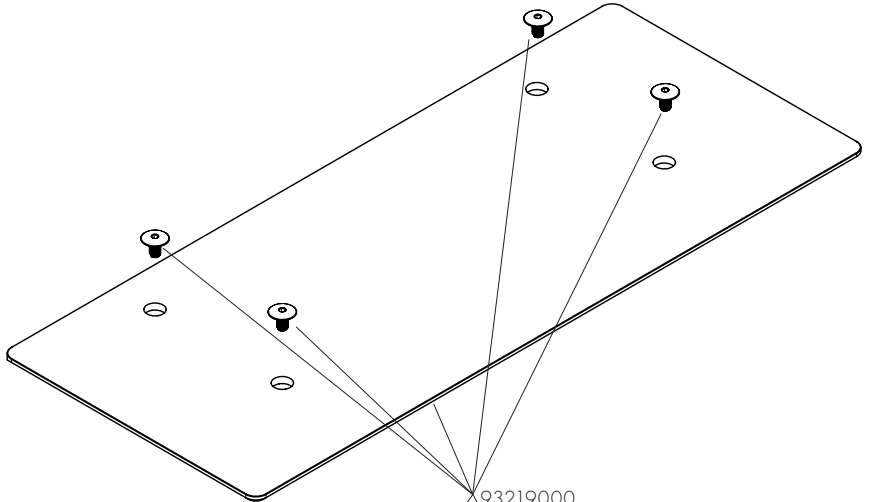

93219000

97604000

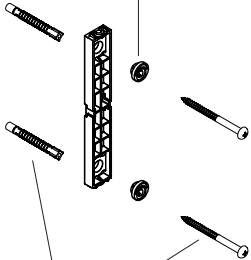

40915000

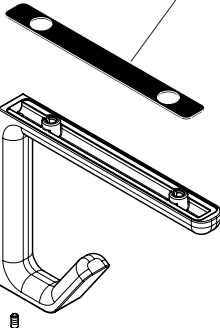

97672000  
(M5x10)

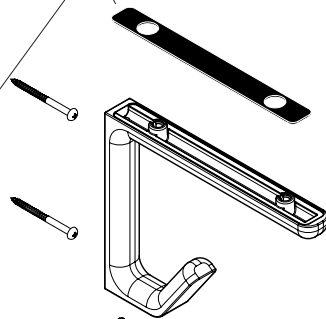

DVGW

SVGW

ACS

WRAS



ETA



GODKENDT  
TIL DRIKKEVAND



- DE / Reinigungsempfehlung / Garantie / Kontakt  
 FR / Recommandation pour le nettoyage / Garanties / Contact  
 EN / Cleaning recommendation / Warranty / Contact  
 IT / Raccomandazione di pulizia / Garanzia / Contatto  
 ES / Recomendaciones para la limpieza / Garantía / Contacto  
 NL / Aanbevelingen inzake reiniging / Garantie / Contact  
 DK / Rensning, anbefaling / Garanti / Kontakt  
 PT / Recomendações de limpeza / Garantia / Contacto  
 PL / Zalecenie dotyczące pielęgnacji / Gwarancja / Kontakt  
 CS / Doporučení k čištění / Záruka / Kontakt  
 SK / Odporúčania pre čistenie / Záruka / Kontakt  
 ZH / 清洁指南 / 担保 / 接触  
 RU / Рекомендации по очистке / Гарантия / Контакты  
 HU / Tisztítási tanácsok / Garancia / érintkezés  
 FI / Puhdistussuositus / Takuu / Kosketus  
 SV / Rengöringsrekommendationer / Garanti / Contacto  
 LT / Valymo rekomendacijos / Garantija / Kontaktai  
 HR / Preporuke za čišćenje / Garancija / Kontakt  
 TR / Temizleme önerisi / Garanti / Temas  
 RO / Recomandări pentru curățare / Garanție / Contact  
 EL / Σύσταση καθαρισμού / Εγγύηση / επαφή  
 SL / Priporočilo za čišćenje / Garancija / Kontakt  
 ET / Puhastussoovitused / Garantii / Kontakt  
 LV / Tīrīšanas ieteikumi / Garantija / Kontakti  
 SR / Preporuke za čišćenje / Garancija / Kontakt  
 NO / Anbefaling for rengjøring / Garanti / Kontakt  
 BG / Препоръка за почистване / Гаранция / Контакт  
 SQ / Këshilla rreth pastrimit / Garancia / Kontakt  
 KO / 세정시 권장사항 / 품질보증 / 접촉  
 AR / توصيات التنظيف / الضمان (الولايات المتحدة الأمريكية) / اتصال



[www.axor-design.com/  
cleaning-recommendation](http://www.axor-design.com/cleaning-recommendation)

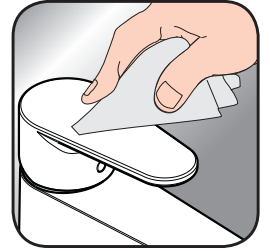

[www.axor-design.com/  
cleaning-recommendation](http://www.axor-design.com/cleaning-recommendation)



[www.axor-design.com/  
cleaning-recommendation](http://www.axor-design.com/cleaning-recommendation)



[www.axor-design.com/  
cleaning-recommendation](http://www.axor-design.com/cleaning-recommendation)

# AXOR

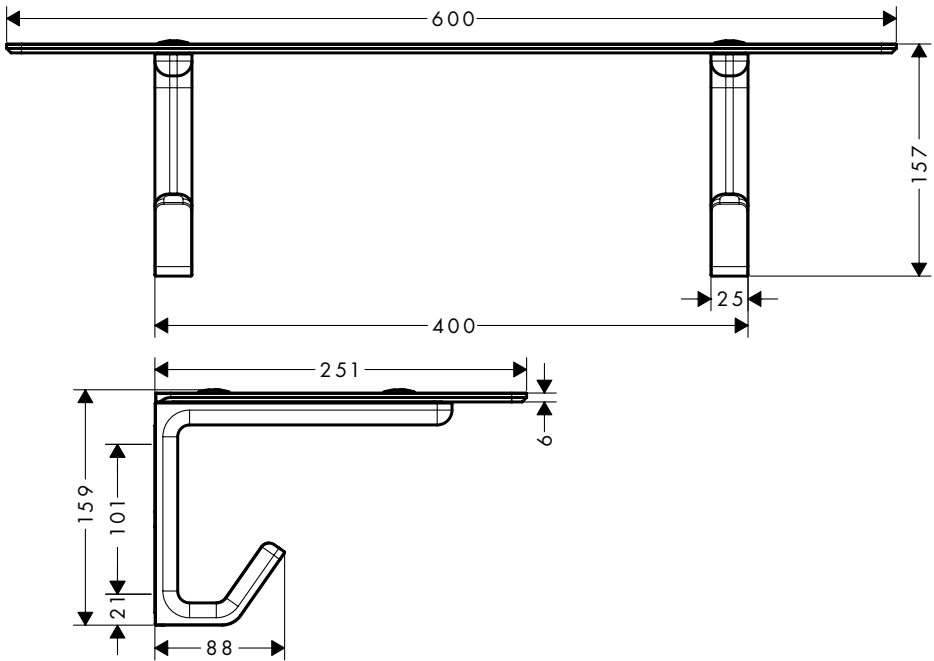

AXOR / Hansgrohe SE

Austraße 5-9

77761 Schiltach

Deutschland

[info@axor-design.com](mailto:info@axor-design.com)

[axor-design.com](http://axor-design.com)

7/2018  
9.06/112.01