



UNIDOMO®

Web: www.unidomo.de

Telefon: 04621- 30 60 89 0

Mail: info@unidomo.com

Öffnungszeiten: Mo.-Fr. 8:00-17:00 Uhr

VIESMANN

Buderus

 **Vaillant**

WOLF

 **JUNKERS**  **BOSCH**



 **remeha**



 **DAIKIN**

ROTEX

a member of DAIKIN group



-  Individuelle Beratung
-  Kostenloser Versand
-  Hochwertige Produkte

-  Komplettpakete
-  Über 15 Jahre Erfahrung
-  Markenhersteller

DE / Gebrauchsanleitung / Montageanleitung	02
FR / Mode d'emploi / Instructions de montage	02
EN / Instructions for use / assembly instructions	03
IT / Istruzioni per l'uso / Istruzioni per Installazione	03
ES / Modo de empleo / Instrucciones de montaje	04
NL / Gebruiksaanwijzing / Handleiding	04
DK / Brugsanvisning / Monteringsvejledning	05
PT / Instruções para uso / Manual de Instalação	05
PL / Instrukcja obsługi / Instrukcja montażu	06
CS / Návod k použití / Montážní návod	06
SK / Návod na použitie / Montážny návod	07
ZH / 用户手册 / 组装说明	07
RU / Руководство пользователя / Инструкция по монтажу	08
HU / Használati útmutató / Szerelési útmutató	08
FI / Käyttöohje / Asennusohje	09
SV / Bruksanvisning / Monteringsanvisning	09
LT / Vartotojo instrukcija / Montavimo instrukcijos	10
HR / Upute za uporabu / Uputstva za instalaciju	10
TR / Kullanım kılavuzu / Montaj kılavuzu	11
RO / Manual de utilizare / Instrucțiuni de montare	11
EL / Οδηγίες χρήσης / Οδηγία συναρμολόγησης	12
SL / Navodilo za uporabo / Navodila za montažo	12
ET / Kasutusjuhend / Paigaldusjuhend	13
LV / Lietošanas pamācība / Montāžas instrukcija	13
SR / Uputstvo za upotrebu / Uputstvo za montažu	14
NO / Bruksanvisning / Montasjeveiledning	14
BG / Инструкция за употреба / Ръководство за монтаж	15
SQ / Udhëzuesi i përdorimit / Udhëzime rreth montimit	15
AR / دليل الاستخدام / تعليمات التجميع	16

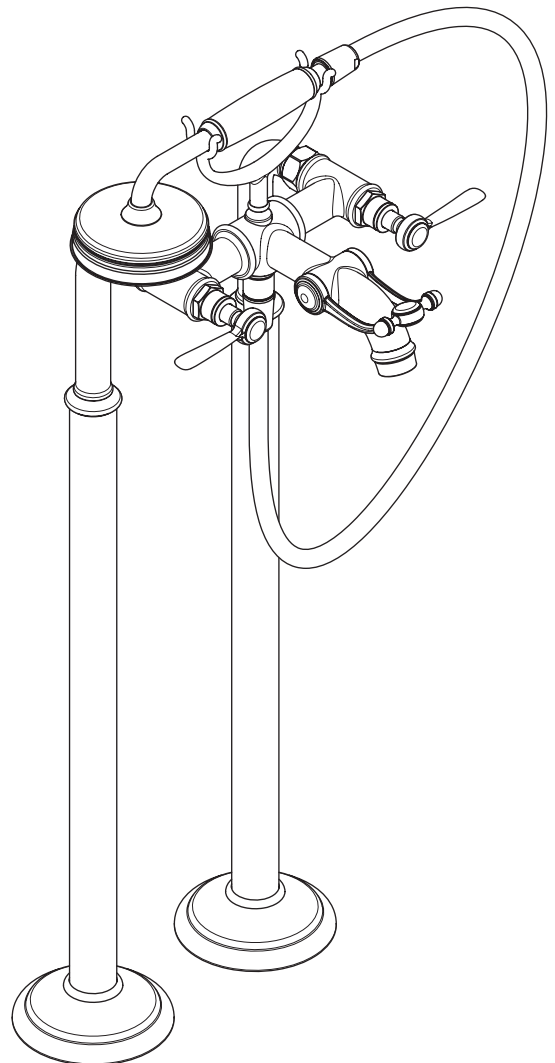

AXOR Montreux
16553XXX

△ SICHERHEITSHINWEISE

- △ Bei der Montage müssen zur Vermeidung von Quetsch- und Schnittverletzungen Handschuhe getragen werden.
- △ Das Produkt darf nur zu Bade-, Hygiene- und Körperreinigungszwecken eingesetzt werden.
- △ Große Druckunterschiede zwischen den Kalt- und Warmwasseranschlüssen müssen ausgeglichen werden.

MONTAGEHINWEISE









- / Vor der Montage muss das Produkt auf Transportschäden untersucht werden. Nach dem Einbau werden keine Transport- oder Oberflächenschäden anerkannt.
- / Die Leitungen und die Armatur müssen nach den gültigen Normen montiert, gespült und geprüft werden.
- / Die in den Ländern jeweils gültigen Installationsrichtlinien sind einzuhalten.

TECHNISCHE DATEN

Betriebsdruck:	max. 1 MPa
Empfohlener Betriebsdruck:	0,1 - 0,5 MPa
Prüfdruck:	1,6 MPa (1 MPa = 10 bar = 147 PSI)
Heißwassertemperatur:	max. 70°C
Empfohlene Heißwassertemperatur:	65°C
Thermische Desinfektion:	max. 70°C/4 min

Das Produkt ist ausschließlich für Trinkwasser konzipiert!

SYMBOLERKLÄRUNG

-  Kein essigsäurehaltiges Silikon verwenden!
-  **MASSE** (siehe Seite 20)
-  **DURCHFLUSSDIAGRAMM** (siehe Seite 20)
-  Warnung vor heißer Oberfläche!
-  **WARTUNG** (siehe Seite 19)
Rückflussverhinderer müssen gemäß DIN EN 1717 regelmäßig in Übereinstimmung mit nationalen oder regionalen Bestimmungen auf ihre Funktion geprüft werden (mindestens einmal jährlich).
-  **SERVICETEILE** (siehe Seite 21)
XXX = Farbcodierung
000 = Chrom
820 = Brushed Nickel
-  **BEDIENUNG** (siehe Seite 19)
-  **REINIGUNG** (siehe Seite 22)
-  **PRÜFZEICHEN** (siehe Seite 21)

STÖRUNG	URSACHE	ABHILFE
/ Wenig Wasser	/ Rückflussverhinderer sitzt fest / Siebdichtung der Brause verschmutzt	/ Rückflussverhinderer austauschen / Siebdichtung zwischen Brause und Schlauch reinigen
/ Durchlauferhitzer schaltet nicht ein	/ Drossel in der Handbrause nicht ausgebaut / Siebdichtung der Brause verschmutzt / Rückflussverhinderer sitzt fest	/ Drossel aus der Handbrause entfernen / Siebdichtung zwischen Brause und Schlauch reinigen / Rückflussverhinderer austauschen

△ CONSIGNES DE SÉCURITÉ

- △ Lors du montage, porter des gants de protection pour éviter toute blessure par écrasement ou coupure.
- △ Le produit ne doit servir qu'à se laver et à assurer l'hygiène corporelle.
- △ Il est conseillé d'équilibrer les pressions de l'eau chaude et froide.

INSTRUCTIONS POUR LE MONTAGE









- / Avant son montage, s'assurer que le produit n'a subi aucun dommage pendant le transport. Après le montage, tout dommage de transport ou de surface ne pourra pas être reconnu.
- / Les conduites et la robinetterie doivent être montés, rincés et contrôlés selon les normes en vigueur.
- / Les directives d'installation en vigueur dans le pays concerné doivent être respectées.

INFORMATIONS TECHNIQUES

Pression de service autorisée:	max. 1 MPa
Pression de service conseillée:	0,1 - 0,5 MPa
Pression maximum de contrôle:	1,6 MPa (1 MPa = 10 bar = 147 PSI)
Température d'eau chaude:	max. 70°C
Température recommandée:	65°C
Désinfection thermique:	max. 70°C/4 min

Le produit est exclusivement conçu pour de l'eau potable!

DESCRIPTION DU SYMBOLE

-  Ne pas utiliser de silicone contenant de l'acide acétique!
-  **DIMENSIONS** (voir pages 20)
-  **DIAGRAMME DU DÉBIT** (voir pages 20)
-  Attention à la température élevée à la surface !
-  **ENTRETIEN** (voir pages 19)
Les clapets anti-retour doivent être examinés régulièrement conformément à la norme EN 1717 ou conformément aux dispositions nationales ou régionales quant à leur fonction (au moins une fois par an).
-  **PIÈCES DÉTACHÉES** (voir pages 21)
XXX = Couleurs
000 = Chromé
820 = Brushed Nickel
-  **INSTRUCTIONS DE SERVICE** (voir pages 19)
-  **NETTOYAGE** (voir pages 22)
-  **CLASSIFICATION ACOUSTIQUE ET DÉBIT** (voir pages 21)

DYSFONCTION- NEMENT	ORIGINE	SOLUTION
/ Pas assez d'eau	/ Clapet anti-retour bloqué / Joint-filtre de douchette encrassé	/ Changez le clapet anti-retour / Nettoyer le joint-filtre entre la douchette et le flexible
/ La chauffe-eau instantané ne s'allume pas	/ Réducteur de débit non démonté / Joint-filtre de douchette encrassé / Clapet anti-retour bloqué	/ Démontez le réducteur de débit de la douchette / Nettoyer le joint-filtre entre la douchette et le flexible / Changez le clapet anti-retour

⚠ SAFETY NOTES

- ⚠ Gloves should be worn during installation to prevent crushing and cutting injuries.
- ⚠ The product may only be used for bathing, hygienic and body cleaning purposes.
- ⚠ The hot and cold supplies must be of equal pressures.

INSTALLATION INSTRUCTIONS

- / Prior to installation, inspect the product for transport damages. After it has been installed, no transport or surface damage will be honoured.
- / The pipes and the fixture must be installed, flushed and tested as per the applicable standards.
- / The plumbing codes applicable in the respective countries must be observed.

TECHNICAL DATA

Operating pressure: max. 1 MPa
 Recommended operating pressure: 0,1 - 0,5 MPa
 Test pressure: 1,6 MPa

(1 MPa = 10 bar = 147 PSI)

Hot water temperature: max. 70°C
 Recommended hot water temp.: 65°C
 Thermal disinfection: max. 70°C/4 min

The product is exclusively designed for drinking water!

⚠ INDICAZIONI SULLA SICUREZZA

- ⚠ Durante il montaggio, per evitare ferite da schiacciamento e da taglio bisogna indossare guanti protettivi.
- ⚠ Il prodotto deve essere utilizzato esclusivamente per fare il bagno e per l'igiene del corpo.
- ⚠ Attenzione! Compensare le differenze di pressione tra i collegamenti dell'acqua fredda e dell'acqua calda.

ISTRUZIONI PER IL MONTAGGIO

- / Prima del montaggio è necessario controllare che non ci siano stati danni durante il trasporto. Una volta eseguito il montaggio, non verranno riconosciuti eventuali danni di trasporto o delle superfici.
- / Montare, lavare e controllare tubature e rubinetteria rispettando le norme correnti.
- / Vanno rispettate le direttive di installazione nazionali vigenti nel rispettivo paese.

DATI TECNICI

Pressione d'uso: max. 1 MPa
 Pressione d'uso consigliata: 0,1 - 0,5 MPa
 Pressione di prova: 1,6 MPa
 (1 MPa = 10 bar = 147 PSI)

Temperatura dell'acqua calda: max. 70°C
 Temp. dell'acqua calda consigliata: 65°C
 Disinfezione termica: max. 70°C/4 min

Il prodotto è concepito esclusivamente per acqua potabile!

SYMBOL DESCRIPTION

 Do not use silicone containing acetic acid!

 DIMENSIONS (see page 20)

 FLOW DIAGRAM (see page 20)

 Hot surface!

 MAINTENANCE (see page 19)
 The check valves must be checked regularly according to DIN EN 1717 in accordance with national or regional regulations (at least once a year).

 SPARE PARTS (see page 21)

XXX = Colors
 000 = Chrome Plated
 820 = Brushed Nickel

 OPERATION (see page 19)

 CLEANING (see page 22)

 TEST CERTIFICATE (see page 21)

FAULT	CAUSE	REMEDY
/ Insufficient water	/ check valve hasn't moved back	/ Exchange check valves
	/ Shower filter seal dirty	/ Clean filter seal between shower and hose
/ Instantaneous heater didn't work	/ Flow limiter in handshower isn't removed	/ Remove flow limiter
	/ Shower filter seal dirty	/ Clean filter seal between shower and hose
	/ check valve hasn't moved back	/ Exchange check valves

DESCRIZIONE SIMBOLO

 Non utilizzare silicone contenente acido acetico!

 INGOMBRI (vedi pagg. 20)

 DIAGRAMMA FLUSSO (vedi pagg. 20)

 Attenzione, superficie molto calda!

 MANUTENZIONE (vedi pagg. 19)
 La valvola di non ritorno deve essere controllata regolarmente come da DIN EN 1717, secondo le normative nazionali e regionali (almeno una volta all'anno).

 PARTI DI RICAMBIO (vedi pagg. 21)

XXX = Trattamento
 000 = Cromato
 820 = Brushed Nickel

 PROCEDURA (vedi pagg. 19)

 PULITURA (vedi pagg. 22)

 SEGNO DI VERIFICA (vedi pagg. 21)

PROBLEMA	POSSIBILE CAUSA	RIMEDIO
/ Scarsità d'acqua	/ Valvola antiriflusso non funziona correttamente	/ Sostituire la valvola antiriflusso
	/ Guarnizione del filtro della doccia sporca	/ Pulire la guarnizione del filtro tra doccia e flessibile
/ La caldaia istantanea non lavora	/ Il limitatore di portata non è stato smontato dalla doccetta	/ Smontare il limitatore di portata dalla doccetta
	/ Guarnizione del filtro della doccia sporca	/ Pulire la guarnizione del filtro tra doccia e flessibile
	/ Valvola antiriflusso non funziona correttamente	/ Sostituire la valvola antiriflusso

INDICACIONES DE SEGURIDAD

- ⚠ Durante el montaje deben utilizarse guantes para evitar heridas por aplastamiento o corte.
- ⚠ El producto solo debe ser utilizado para fines de baño, higiene y limpieza corporal.
- ⚠ Grandes diferencias de presión en servicio entre agua fría y agua caliente deben equilibrarse.

INDICACIONES PARA EL MONTAJE

- / Antes del montaje se debe examinar el producto contra daños de transporte. Después de la instalación no se reconoce ningún daño de transporte o de superficie.
- / Los conductos y la grifería deben montarse, lavarse y comprobarse según las normas vigentes.
- / Es obligatorio el cumplimiento de las directrices de instalación vigentes en el país respectivo.

DATOS TÉCNICOS

Presión en servicio:	max. 1 MPa
Presión recomendada en servicio:	0,1 - 0,5 MPa
Presión de prueba:	1,6 MPa (1 MPa = 10 bar = 147 PSI)
Temperatura del agua caliente:	max. 70°C
Temp. recomendada del agua caliente:	65°C
Desinfección térmica:	max. 70°C/4 min

El producto ha sido concebido exclusivamente para agua potable.

DESCRIPCIÓN DE SÍMBOLOS

 No utilizar silicona que contiene ácido acético!

 DIMENSIONES (ver página 20)

 DIAGRAMA DE CIRCULACIÓN (ver página 20)

 ¡Atención, superficie muy caliente!

 MANTENIMIENTO (ver página 19)
Las válvulas anti-retorno tienen que ser controladas regularmente según la norma DIN EN 1717, en acuerdo con las regulaciones nacionales o regionales (una vez al año, por lo menos).

 REPUESTOS (ver página 21)
XXX = Acabados
000 = Cromado
820 = Brushed Nickel

 MANEJO (ver página 19)

 LIMPIAR (ver página 22)

 MARCA DE VERIFICACIÓN (ver página 21)

PROBLEMA	CAUSA	SOLUCIÓN
/ Sale poca agua	/ válvula anti-retorno cerrada / Filtro de la teleducha sucio	/ cambiar válvula anti-retorno / Limpiar/Cambiar filtro entre flexo y teleducha
/ Calentador instantáneo no se enciende	/ no se ha quitado limitador de caudal de la teleducha / Filtro de la teleducha sucio / válvula anti-retorno cerrada	/ quitar limitador de caudal de caudal de la teleducha / Limpiar/Cambiar filtro entre flexo y teleducha / cambiar válvula anti-retorno

VEILIGHEIDSINSTRUCTIES

- ⚠ Bij de montage moeten ter voorkoming van knel- en snijwonden handschoenen worden gedragen.
- ⚠ Het product mag alleen voor het wassen, hygiënische doeleinden en voor de lichaamreiniging worden gebruikt.
- ⚠ Grote drukverschillen tussen de koud- en warmwatertoevoer dienen vermeden te worden.

MONTAGE-INSTRUCTIES

- / Vóór de montage moet het product gecontroleerd worden op transportschade. Na de inbouw wordt geen transport- of oppervlakteschade meer aanvaard.
- / De leidingen en armaturen moeten gemonteerd, gespoeld en gecontroleerd worden volgens de geldige normen.
- / De in de overeenkomstige landen geldende installatierichtlijnen moeten nageleefd worden.

TECHNISCHE GEGEVENS

Werkdruk: max.	max. 1 MPa
Aanbevolen werkdruk:	0,1 - 0,5 MPa
Getest bij:	1,6 MPa (1 MPa = 10 bar = 147 PSI)
Temperatuur warm water:	max. 70°C
Aanbevolen warm water temp.:	65°C
Thermische desinfectie:	max. 70°C/4 min

Het product is uitsluitend ontworpen voor drinkwater!

SYMBOOLBESCHRIJVING

 Gebruik geen zuurhoudende silicone!

 MATEN (zie blz. 20)

 DOORSTROOMDIAGRAM (zie blz. 20)

 Let op: heet!

 ONDERHOUD (zie blz. 19)
Keerkleppen moeten volgens DIN EN 1717 regelmatig en volgens plaatselijk geldende eisen op het functioneren gecontroleerd worden. (Tenminste een keer per jaar)

 SERVICE ONDERDELEN (zie blz. 21)
XXX = Kleuren
000 = Verchroomd
820 = Brushed Nickel

 BEDIENING (zie blz. 19)

 REINIGEN (zie blz. 22)

 KEURMERK (zie blz. 21)

STORING	OORZAAK	OPLOSSING
/ Weinig water	/ Terugslagklep zit vast / Zeefdichting handdouche verstopt	/ Terugslagklep uitwisselen / Zeefdichting handdouche reinigen
/ Doorstroomtoestel schakelt niet in	/ Begrenzer van handdouche niet verwijderd / Zeefdichting handdouche verstopt / Terugslagklep zit vast	/ Begrenzer uit handdouche verwijderen / Zeefdichting handdouche reinigen / Terugslagklep uitwisselen

⚠ SIKKERHEDSANVISNINGER

- ⚠ Ved monteringen skal der bruges handsker for at undgå kvæstelser og snitsår.
- ⚠ Produktet må kun bruges til bade-, hygiejne og kropsurengøringsformål.
- ⚠ Større trykforskelle mellem koldt og varmt vand bør udjævnes.

MONTERINGSANVISNINGER

- / Før monteringen skal produktet kontrolleres for transportskader. Efter monteringen godkendes transportskader eller skader på overfladen ikke længere.
- / Ledningerne og armaturerne skal monteres, skylles og kontrolleres iht. de gældende standarder.
- / Installationsbestemmelserne, der gælder i det enkelte land, skal overholdes.

TEKNISKE DATA

Driftstryk:	max. 1 MPa
Anbefalet driftstryk:	0,1 - 0,5 MPa
Prøvetryk:	1,6 MPa
	(1 MPa = 10 bar = 147 PSI)
Varmtvandstemperatur:	max. 70°C
Anbefalet varmtvandsstemperatur:	65°C
Termisk desinfektion:	max. 70°C/4 min

Produktet er udelukkende beregnet til drikkevand!

SYMBOLBESKRIVELSE

-  Der må ikke benyttes eddikesyreholdig silikone!
-  MÅLENE (se s. 20)
-  GENNEMSTRØMNINGSDIAGRAM (se s. 20)
-  Varm overflade!
-  SERVICE (se s. 19)
Ifølge DIN EN 1717 skal gennemstrømningsbegrænsere i overensstemmelse med nationale regler afprøves regelmæssigt (mindst en gang om året).
-  RESERVEDELE (se s. 21)
XXX = Overflade
000 = Krom
820 = Brushed Nickel
-  BRUGSANVISNING (se s. 19)
-  RENGØRING (se s. 22)
-  GODKENDELSE (se s. 21)

FEIL	ÅRSAG	HJÆLP
/ For lidt vand	/ Kontraventilen hænger	/ Udskift kontraventil
	/ Sien mellem bruser og slange er snævset	/ Rengør sien mellem bruser og slange
/ Vandvarmeren går ikke i gang	/ Vandsparen i håndbruseren er ikke fjernet	/ Afmonter vandsparen i håndbruseren
	/ Sien mellem bruser og slange er snævset	/ Rengør sien mellem bruser og slange
	/ Kontraventilen hænger	/ Udskift kontraventil

⚠ AVISOS DE SEGURANÇA

- ⚠ Durante a montagem devem ser utilizadas luvas de protecção, de modo a evitar ferimentos resultantes de entalamentos e de cortes.
- ⚠ O produto só pode ser utilizado para fins de higiene pessoal.
- ⚠ Grandes diferenças entre as pressões das águas quente e fria devem ser compensadas.

AVISOS DE MONTAGEM









- / Antes da montagem deve-se controlar o produto relativamente a danos de transporte. Após a montagem não são aceites quaisquer danos de transporte ou de superfície.
- / As tubagens e a torneira têm que ser montadas, enxaguadas e verificadas de acordo com as normas em vigor.
- / A prescrições de instalação válidas nos respetivos países devem ser respeitadas.

DADOS TÉCNICOS

Pressão de funcionamento:	max. 1 MPa
Pressão de func. recomendada:	0,1 - 0,5 MPa
Pressão testada:	1,6 MPa
	(1 MPa = 10 bar = 147 PSI)
Temperatura da água quente:	max. 70°C
Temp. água quente recomendada:	65°C
Desinfecção térmica:	max. 70°C/4 min

Este produto foi única e exclusivamente concebido para água potável!

DESCRIÇÃO DO SÍMBOLO

-  Não utilizar silicone que contenha ácido acético!
-  MEDIDAS (ver página 20)
-  FLUXOGRAMA (ver página 20)
-  Superfície quente!
-  MANUTENÇÃO (ver página 19)
As válvulas anti-retorno devem ser verificadas regularmente de acordo com a DIN EN 1717 segundo os regulamentos nacionais ou regionais (pelo menos uma vez por ano).
-  PEÇAS DE SUBSTITUIÇÃO (ver página 21)
XXX = Acabamentos
000 = Cromado
820 = Brushed Nickel
-  FUNCIONAMENTO (ver página 19)
-  LIMPEZA (ver página 22)
-  MARCA DE CONTROLO (ver página 21)

FALHA	CAUSA	SOLUÇÃO
/ Água insuficiente	/ Válvula anti-retorno está presa	/ Trocar a válvula anti-retorno
	/ Filtro do vedante do chuveiro sujo	/ Limpar o filtro entre o chuveiro e o tubo flexível
/ O esquentador instantâneo não funciona	/ O limitador de caudal não foi retirado	/ Retirar o limitador de caudal
	/ Filtro do vedante do chuveiro sujo	/ Limpar o filtro entre o chuveiro e o tubo flexível
	/ Válvula anti-retorno está presa	/ Trocar a válvula anti-retorno

Δ WSKAZÓWKI BEZPIECZEŃSTWA

- Δ Aby uniknąć zranień na skutek zgniecenia lub przecięcia, podczas montażu należy nosić rękawice ochronne.
- Δ Produkt może być używany tylko do kąpieli, higieny i czyszczenia ciała.
- Δ Znaczne różnice ciśnień na dopływach ciepłej i zimnej wody muszą zostać wyrównane.

WSKAZÓWKI MONTAŻOWE

- / Przed montażem należy skontrolować produkt pod kątem szkód transportowych. Po montażu nie widać żadnych szkód transportowych ani szkód na powierzchni.
- / Przewody i armatura muszą być montowane, płukane i kontrolowane według obowiązujących norm.
- / Należy przestrzegać wytycznych instalacyjnych obowiązujących w danym kraju.

DANE TECHNICZNE

Ciśnienie robocze:	maks. 1 MPa
Zalecane ciśnienie robocze:	0,1 - 0,5 MPa
Ciśnienie próbne:	1,6 MPa (1 MPa = 10 bary = 147 PSI)
Temperatura wody gorącej:	maks. 70°C
Zalecana temperatura wody gorącej:	65°C
Dezynfekcja termiczna:	maks. 70°C/4 min

Produkt przeznaczony wyłącznie do wody pitnej!

OPIS SYMBOLU

Nie stosować silikonów zawierających kwas octowy!



WYMIARY (patrz strona 20)



SCHEMAT PRZEPŁYWU (patrz strona 20)



Uwaga na gorącą powierzchnię!



KONSERWACJA (patrz strona 19)

Zgodnie z normą DIN EN 1717, krajowymi i miejscowymi przepisami, działania zabezpieczeń przed przepływem zwrotnym musi być kontrolowane (przynajmniej raz w roku).



CZĘŚCI SERWISOWE (patrz strona 21)

XXX = Kody kolorów
000 = Chrom
820 = Brushed Nickel



OBSŁUGA (patrz strona 19)



CZYSZCZENIE (patrz strona 22)



ZNAK JAKOŚCI (patrz strona 21)

USTERKA	PRZYCZYNA	POMOC
/ Mała ilość wody	/ Zablokowane zabezpieczenie przed przepływem zwrotnym	/ Wymienić zabezpieczenie przed przepływem zwrotnym
	/ Zabrudzona uszczelka z sitkiem w prysznicy	/ Oczyszczyć uszczelkę z sitkiem pomiędzy prysznicem a wężem
/ Przepływowy podgrzewacz wody nie załącza się	/ Dławik przepływu nie został usunięty z prysznicy ręcznego	/ Usunąć dławik z prysznicy ręcznego
	/ Zabrudzona uszczelka z sitkiem w prysznicy	/ Oczyszczyć uszczelkę z sitkiem pomiędzy prysznicem a wężem
	/ Zablokowane zabezpieczenie przed przepływem zwrotnym	/ Wymienić zabezpieczenie przed przepływem zwrotnym

MONTAŻ (patrz strona 17)

**Δ BEZPEČNOSTNÍ POKYNY**

- Δ Pro zabránění řezným zraněním a pohmožděninám je nutné při montáži nosit rukavice.
- Δ Produkt smí být používán pouze ke koupání a za účelem tělesné hygieny.
- Δ Je nutné vyrovnat velké rozdíly tlaku mezi přípoji studené a teplé vody.

POKYNY K MONTÁŽI

- / Před montáží je třeba produkt zkontrolovat, zda nebyl při transportu poškozen. Po zabudování nebudou uznány žádné škody způsobené transportem nebo poškození povrchu.
- / Vedení a armatura musí být namontovány, propláchnuty a otestovány podle platných norem.
- / Je třeba dodržovat montážní pravidla platné v dané zemi.

TECHNICKÉ ÚDAJE

Provozní tlak:	max. 1 MPa
Doporučený provozní tlak:	0,1 - 0,5 MPa
Zkušební tlak:	1,6 MPa (1 MPa = 10 bar = 147 PSI)
Teplota horké vody:	max. 70°C
Doporučená teplota horké vody:	65°C
Teplná desinfekce:	max. 70°C/4 min

Výrobky Hansgrohe jsou vhodné pro přímý kontakt s pitnou vodou.

POPIS SYMBOLŮ

Nepoužívat silikon s obsahem kyseliny octové!



ROZMĚRY (viz strana 20)



DIAGRAM PRŮTOKU (viz strana 20)



Pozor, horký povrch!



ÚDRŽBA (viz strana 19)

U zpětných ventilů se musí podle DIN EN 1717 v souladu s národními nebo regionálními předpisy testovat jejich funkčnost (alespoň jednou ročně).



SERVISNÍ DÍLY (viz strana 21)

XXX = Kód povrchové úpravy
000 = Chrom
820 = Brushed Nickel



OVLÁDÁNÍ (viz strana 19)



ČIŠTĚNÍ (viz strana 22)



ZKUŠEBNÍ ZNAČKA (viz strana 21)

PORUCHA	PŘÍČINA	ODSTRANĚNÍ
/ Málo vody	/ Zpětný ventil je zablokovaný	/ Vyměnit zpětný ventil
	/ Sítko v těsnění u sprchy zanesené	/ Vyčistit sítko v těsnění mezi sprchou a hadicí
/ Průtokový ohříváč nezapíná	/ Není odstraněn kroužek ze sprchy	/ Odstranit kroužek ze sprchy
	/ Sítko v těsnění u sprchy zanesené	/ Vyčistit sítko v těsnění mezi sprchou a hadicí
	/ Zpětný ventil je zablokovaný	/ Vyměnit zpětný ventil

MONTÁŽ (viz strana 17)



△ BEZPEČNOSTNÉ POKYNY

- △ Pri montáži musíte nosiť rukavice, aby ste predišli pomliaždeninám a rezným poraneniam.
- △ Produkt sa smie používať len na kúpanie a telesnú hygienu.
- △ Veľké rozdiely v tlaku medzi prípojkami studenej a teplej vody musia byť vyrovnané.

POKYNY PRE MONTÁŽ

- / Pred montážou musíte produkt skontrolovať, či nebol počas transportu poškodený. Po zabudovaní nebudú uznané žiadne škody spôsobené transportom alebo poškodenia povrchu.
- / Ledningarna och blandaren måste monteras, spolás igenom och kontrolleras enligt de gällande normerna.
- / Je potrebné dodržiavať smernice o inštalácii, ktoré sú práve teraz platné v krajinách.

TECHNICKÉ ÚDAJE

Prevádzkový tlak:	max. 1 MPa
Doporučený prevádzkový tlak:	0,1 - 0,5 MPa
Skúšobný tlak:	1,6 MPa (1 MPa = 10 bar = 147 PSI)
Teplota teplej vody:	max. 70°C
Doporučená teplota teplej vody:	65°C
Termická dezinfekcia:	max. 70°C / 4 min

Výrobok je koncipovaný výhradne pre pitnú vodu!

POPIS SYMBOLOV

 Nepoužívať silikón s obsahom kyseliny octovej!

 ROZMERY (viď strana 20)

 DIAGRAM PRIETOKU (viď strana 20)

 Pozor, horúci vzduch!

 ÚDRŽBA (viď strana 19)
Pri spätných ventiloch sa musí podľa DIN EN 1717 v súlade s národnými alebo regionálnymi predpismi testovať ich funkčnosť (aspoň raz ročne).

 SERVISNÉ DIELY (viď strana 21)

XXX = Farebné označenie
000 = Chróm
820 = Brushed Nickel

 OBSLUHA (viď strana 19)

 ČISTENIE (viď strana 22)

 OSVEDČENIE O SKÚŠKE (viď strana 21)

PORUCHA	PRÍČINA	POMOC
/ Málo vody	/ Obmedzovač spätného nasatia je zablokovaný / Sítko v tesnení sprchy je znečistené	/ Vymeniť obmedzovač spätného nasatia / Vyčistiť sítko tesnení medzi sprchou a hadicou
/ Prietokový ohrievač nezapína	/ Nie je odstránený krúžok zo sprchy / Sítko v tesnení sprchy je znečistené / Obmedzovač spätného nasatia je zablokovaný	/ Odstrániť krúžok zo sprchy / Vyčistiť sítko tesnení medzi sprchou a hadicou / Vymeniť obmedzovač spätného nasatia

△ 安全技巧

- △ 装配时为避免挤压和切割受伤，必须戴上手套。
- △ 本产品只允许作为洗浴、卫生和洁身之用。
- △ 冷热水管间过大的压力差必须予以平衡。

安装提示

- / 安装前必须检查产品是否受到运输损害。安装后将不认可运输损害或表面损伤。
- / 管道和阀门必须根据通用标准进行安装、冲洗和检查。
- / 请遵守当地国家现行的安装规定。

技术参数

工作压力:	最大 1 MPa
推荐工作压力:	0,1 - 0,5 MPa
测试压强:	1,6 MPa (1 MPa = 10 bar = 147 PSI)
热水温度:	最大 70°C
推荐热水温度:	65°C
热力消毒:	最大 70°C / 4 分钟

该产品专为饮用水设计！

符号说明

 请勿使用含有乙酸的硅胶！

 大小 (参见第页 20)

 流量示意图 (参见第页 20)

 热表面！

 保养 (参见第页 19)
单向阀必须在符合国家或当地的法律的情况下按照DIN EN 1717定期检查 (至少一年一次)。

 备用零件 (参见第页 21)

XXX = 颜色代码
000 = 镀铬
820 = Brushed Nickel

 操作 (参见第页 19)

 清洗 (参见第页 22)

 检验标记 (参见第页 21)

问题	原因	补救
/ 龙头出水量小	/ 单向阀装反 / 花洒滤网有垃圾堵塞	/ 正确安装单向阀 / 清洗花洒和软管间的过滤网
/ 燃气热水器不工作	/ 手持花洒的流量限制器没有去除 / 花洒滤网有垃圾堵塞 / 单向阀装反	/ 去除流量限制器 / 清洗花洒和软管间的过滤网 / 正确安装单向阀

УКАЗАНИЯ ПО ТЕХНИКЕ БЕЗОПАСНОСТИ

- △ Во время монтажа следует надеть перчатки во избежание прищемления и порезов.
- △ Изделие разрешается использовать только в гигиенических целях: для принятия ванны и личной гигиены.
- △ донного клапа. Перед установкой смесителя необходимо регулировочными кранами выровнять давление холодной и горячей воды при помощи вентилей регулирующих подачу воды в квартиру.

УКАЗАНИЯ ПО МОНТАЖУ

- / Перед монтажом следует проверить изделие на предмет повреждений при перевозке. После монтажа претензии о возмещении ущерба за повреждения при перевозке или повреждения поверхностей не принимаются.
- / Трубы и арматура должны быть установлены, промыты и проверены в соответствии с действующими нормами.
- / Необходимо соблюдать требования по монтажу, действующие в соответствующих странах.

ТЕХНИЧЕСКИЕ ДАННЫЕ

Рабочее давление:	не более 1 МПа
Рекомендуемое рабочее давление:	0,1 - 0,5 МПа
Давление:	1,6 МПа (1 МПа = 10 bar = 147 PSI)
Температура горячей воды:	не более 70°C
Рекомендуемая темп. гор. воды:	65°C
Термическая дезинфекция:	не более 70°C/4 мин

Изделие предназначено исключительно для питьевой воды!

ОПИСАНИЕ СИМВОЛОВ

-  Не применяйте силикон, содержащий уксусную кислоту.
-  РАЗМЕРЫ (см. стр. 20)
-  СХЕМА ПОТОКА (см. стр. 20)
-  Осторожно! Горячая поверхность!
-  ТЕХНИЧЕСКОЕ ОБСЛУЖИВАНИЕ (см. стр. 19)
Защита обратного тока должна регулярно проверяться (минимум один раз в год) по стандарту DIN EN 1717 или в соответствии с национальными или региональными нормативами
-  КОМПЛЕКТ (см. стр. 21)
XXX = Цветная кодировка
000 = Хром
820 = Brushed Nickel
-  ЭКСПЛУАТАЦИЯ (см. стр. 19)
-  ОЧИСТКА (см. стр. 22)
-  ЗНАК ТЕХНИЧЕСКОГО КОНТРОЛЯ (см. стр. 21)

НЕИСПРАВНОСТЬ ПРИЧИНА

НЕИСПРАВНОСТЬ ПРИЧИНА	УСТРАНЕНИЕ НЕИСПРАВНОСТИ
/ недостаточный давление (если устан напор воды)	/ Клапан обратного тока заедает / Фильтр душа загрязнен
/ Проточный нагреватель не включается	/ Дроссель не удален из ручного душа / Фильтр душа загрязнен / Клапан обратного тока заедает
	/ Замените клапаны обратного течения / Очистить фильтр / Извлеките дроссель из ручного душа / Очистить фильтр / Замените клапаны обратного течения



BIZTONSÁGI UTASÍTÁSOK

- △ A szerelésnél a zúzódások és vágási sérülések elkerülése érdekében kesztyűt kell viselni.
- △ A terméket csak fürdéshez, mosakodáshoz, és egészségügyi tisztálkodáshoz szabad használni.
- △ A hidegvíz- és a melegvíz-csatlakozások közötti nagy nyomáskülönbséget kikell egyenlíteni!

SZERELÉSI UTASÍTÁSOK







- / A szerelés előtt ellenőrizni kell, hogy a terméknek nincs-e szállítási sérülése. Beépítés után a szállítási- vagy felületi sérüléseket nem ismerik el.
- / A vezetékeket és a csaptelepet az érvényes szabványoknak megfelelően kell felszerelni, öblíteni és ellenőrizni
- / Az egyes országokban érvényes installációs irányelveket be kell tartani.

MŰSZAKI ADATOK

Üzemi nyomás:	max. 1 MPa
Ajánlott üzemi nyomás:	0,1 - 0,5 MPa
Nyomáspróba:	1,6 MPa (1 MPa = 10 bar = 147 PSI)
Forróvíz hőmérséklet:	max. 70°C
Forróvíz javasolt hőmérséklete:	65°C
Termikus fertőtlenítés:	max. 70°C/4 perc

A terméket kizárólag ivóvízhez tervezték!

SZIMBÓLUMOK LEÍRÁSA

-  Ne használjon ecetsavtartalmú szilikont!
-  MÉRETET (lásd a oldalon 20)
-  ÁTFOLYÁSI DIAGRAMM (lásd a oldalon 20)
-  Vigyázat! Forró felületek!
-  KARBANTARTÁS (lásd a oldalon 19)
A visszafolyásgátlók működése a DIN EN 1717 szabványnak megfelelően, a nemzeti vagy területi rendelkezésekkel összhangban, évente egyszer ellenőrizendő!
-  TARTOZÉKOK (lásd a oldalon 21)
XXX = Színkódolás
000 = Króm
820 = Brushed Nickel
-  HASZNÁLAT (lásd a oldalon 19)
-  TISZTÍTÁS (lásd a oldalon 22)
-  VIZSGAJEL (lásd a oldalon 21)

HIBA

HIBA	OK	MEGOLDÁS
/ Kevés víz	/ A visszafolyásgátló be- ragadt. / A zuhany szűrőtítmítése koszos	/ A visszafolyásgátló kicse- relése javasolt. / A zuhany és a cső közötti szűrőt ki kell tisztítani
/ Az átfolyós vízmelegítő nem kapcsol be.	/ Nincs kiserelve a zuhany- rózsából a vízmennyiség szabályozó. / A zuhany szűrőtítmítése koszos / A visszafolyásgátló be- ragadt.	/ El kell távolítani a vízmennyi- ség szabályozót. / A zuhany és a cső közötti szűrőt ki kell tisztítani / A visszafolyásgátló kicse- relése javasolt.



△ TURVALLISUUSOHJEET

- △ Asennuksessa on käytettävä käsiineitä puristumien ja viiltojen aiheuttamien tapaturmien estämiseksi.
- △ Tuotetta saa käyttää ainoastaan kylpy-, hygienia- ja puhdistustarkoituksiin.
- △ Suuret paine-erot kylmä- ja kuumavesiliitäntöjen välillä on tasattava.

ASENNUSOHJEET

- / Ennen asennusta on tarkastettava tuotteen mahdolliset kuljetusvahingot. Asennuksen jälkeen kuljetus- ja pintavaurioita ei hyväksytä.
- / Putket ja hana on asennettava, huuhdeltava ja tarkastettava voimassa olevien standardien mukaisesti.
- / Jokaisessa maassa on noudatettava siellä päteviä asennusohjeita.

TEKNISET TIEDOT

Käyttöpaine:	maks. 1 MPa
Suosittelut käyttöpaine:	0,1 - 0,5 MPa
Koestuspaine:	1,6 MPa (1 MPa = 10 bar = 147 PSI)
Kuuman veden lämpötila:	maks. 70°C
Kuuman veden suosituslämpötila:	65°C
Lämpödesinfektio:	maks. 70°C / 4 min

Tuote on suunniteltu käytettäväksi ainoastaan juomaveden kanssa!

△ SÄKERHETSANVISNINGAR

- △ Handskar ska bäras under monteringsarbetet så att man kan undvika kläm- och skärskadorgen werden.
- △ Produkten får bara användas till kroppshygien med bad och dusch.
- △ Stora tryckskillnader mellan anslutningarna för varmt och kallt vatten måste utjämnas.

MONTERINGSANVISNINGAR

- / Det måste undersökas om produkten har transportskador innan den monteras. Efter monteringen accepteras inga transport- eller ytskiktskador.
- / Ledningarna och blandaren måste monteras, spolas igenom och kontrolleras enligt de gällande normerna.
- / De installationsriktlinjer som gäller i länderna ska följas.

TEKNISKA DATA

Driftstryck:	max. 1 MPa
Rek. driftstryck:	0,1 - 0,5 MPa
Tryck vid provtryckning:	1,6 MPa (1 MPa = 10 bar = 147 PSI)
Varmvattentemperatur:	max. 70°C
Rek. varmvattentemp.:	65°C
Termisk desinfektion:	max. 70°C / 4 min

Produkten är enbart avsedd för dricksvatten!

MERKIN KUVAUS

 Älä käytä etikkahappopitoista silikonial!

 MITAT (katso sivu 20)

 VIRTAUSDIAGRAMMI (katso sivu 20)

 Varoitus kuumasta pinnasta!

 HUOLTO (katso sivu 19)
Vastaventtiilien toiminta on tarkastettava säännöllisesti paikallisten ja kansallisten määräysten mukaisesti (DIN EN 1717, vähintään kerran vuodessa).

 VARAOSAT (katso sivu 21)
XXX = Värikoodaus
000 = Kromi
820 = Brushed Nickel

 KÄYTTÖ (katso sivu 19)

 PUHDISTUS (katso sivu 22)

 KOESTUSMERKKI (katso sivu 21)

SYMBOLFÖRKLARING

 Använd inte silikon som innehåller ättiksyra!

 MÅTTEN (se sidan 20)

 FLÖDESSCHEMA (se sidan 20)

 Varning för het yta!

 SKÖTSEL (se sidan 19)
Backventilens funktion måste kontrolleras regelbundet enligt nationella eller regionala bestämmelser i enlighet med DIN EN 1717 (minst en gång per år).

 RESERVDLAR (se sidan 21)
XXX = Färgkodning
000 = Krom
820 = Brushed Nickel

 HANTERING (se sidan 19)

 RENGÖRING (se sidan 22)

 TESTSIGILL (se sidan 21)

HÄIRIÖ	SYY	TOIMENPIDE
/ Vähän vettä	/ Suuntaisventtiili juuttunut	/ Vaihda suuntaisventtiili
	/ Käsisiuhkun sihttiiviste likaantunut	/ Puhdista siuhkukahvan ja letkun välissä oleva sihttiiviste
/ Läpimenokuumennin ei kytkeydy päälle	/ Käsisiuhkussa olevaa kuristinta ei ole poistettu	/ Poista kuristin käsisiuhkusta
	/ Käsisiuhkun sihttiiviste likaantunut	/ Puhdista siuhkukahvan ja letkun välissä oleva sihttiiviste
	/ Suuntaisventtiili juuttunut	/ Vaihda suuntaisventtiili

STÖRNING	ORSAK	ÅTGÄRD
/ För lite vatten	/ Backventil är defekt	/ Byt backventil
	/ Silfiltret i duschen smutsigt	/ Rengör silfiltret mellan slangen och termostaten
/ Varmvattenberedare slår ej på	/ Vattenbegränsare i handduschen har ej tagits bort	/ Ta bort vattenbegränsaren
	/ Silfiltret i duschen smutsigt	/ Rengör silfiltret mellan slangen och termostaten
	/ Backventil är defekt	/ Byt backventil

SAUGUMO TECHNIKOS NURODYMAI

- ⚠ Apsaugai nuo užspaudimo ir įsijovimo montavimo metu mūvėkite pirštines.
- ⚠ Gaminys turi būti naudojamas tik maudymuisi, kūno higienai ir švarai palaikyti.
- ⚠ Turi būti išlyginti šalto ir karšto slėgio nelygumai.

MONTAVIMO INSTRUKCIJA









- / Prieš montuojant būtina patikrinti, ar gaminys nebuvo pažeistas transportavimo metu. Sumontavus pretenzijos dėl transportavimo ir paviršiaus pažeidimų nepriimamos.
- / Vamzdžiai ir sujungimai turi būti montuojami, plaunami ir tikrinami pagal galiojančias normas.
- / Laikykitės atitinkamoje šalyje galiojančių direktyvų dėl įrengimo.

TECHNINIAI DUOMENYS

Darbinis slėgis:	ne daugiau kaip 1 MPa
Rekomenduojamas slėgis:	0,1 - 0,5 MPa
Bandomasis slėgis:	1,6 MPa (1 MPa = 10 barų = 147 PSI)
Karšto vandens temperatūra:	ne daugiau kaip 70°C
Rekomenduojama karšto vandens temperatūra:	65°C
Terminis dezinfekavimas:	ne daugiau kaip 70°C/4 min

Produktas skirtas tik geriamajam vandeniui!

SIMBOLIO APRAŠYMAS

-  Nenaudokite silikono, kurio sudėtyje yra acto rūgšties!
-  IŠMATAVIMAI (žr. psl. 20)
-  PRALAUDIMO DIAGRAMA (žr. psl. 20)
-  Karštas paviršius!
-  TECHNINIS APTARNAVIMAS (žr. psl. 19)
Atbulinio vožtuvo apsauga privalo būti tikrinama reguliariai (mažiausiai kartą per metus) pagal DIN EN1717 arba pagal galiojančias nacionalines arba regionines normas.
-  ATSARGINĖS DALYS (žr. psl. 21)
XXX = Spalvos
000 = Chrom
820 = Brushed Nickel
-  EKSPLOATACIJA (žr. psl. 19)
-  VALYMAS (žr. psl. 22)
-  BANDYMO PAŽYMA (žr. psl. 21)

GEDIMAS	PRIEŽASTIS	PRIEMONĖ
/ Per maža srovė	/ Abulinis vožtuvas neveikia / Dušo galvos filtras užsikimšęs	/ Pakeisti atbulinį vožtuvą / Išvalyti dušo galvos filtrą
/ Momentinis pašildytojas neįsijungia	/ Neišimtas ribotuvas iš dušo galvutės / Dušo galvos filtras užsikimšęs / Abulinis vožtuvas neveikia	/ Išimti ribotuvą iš dušo galvutės / Išvalyti dušo galvos filtrą / Pakeisti atbulinį vožtuvą

**SIGURNOSNE UPUTE**

- ⚠ Prilikom montaže se radi sprječavanja prignječanja i posjekotina moraju nositi rukavice.
- ⚠ Proizvod se smije primjenjivati samo za kupanje, tuširanje i osobnu higijenu.
- ⚠ Velika razlika u pritisku između vruće i hladne vode mora biti izbalansirana.

UPUTE ZA MONTAŽU









- / Prije montaže mora se provjeriti je li proizvod oštećen prilikom transporta. Nakon ugradnje se ne priznaju nikakve reklamacije koje se odnose na površinska i transportna oštećenja.
- / Cijevi i armatura moraju biti postavljene, isprani i testirani prema važećim normama.
- / Obvezno se moraju uvažiti propisi o instalacijama koji vrijede u dotičnoj zemlji.

TEHNIČKI PODATCI

Najveći dopušteni tlak:	tlak 1 MPa
Preporučeni tlak:	0,1 - 0,5 MPa
Probnii tlak:	1,6 MPa (1 MPa = 10 bar = 147 PSI)
Temperatura vruće vode:	tlak 70°C
Preporučena temperatura vruće vode:	65°C
Termička dezinfekcija:	tlak 70°C/4 min

Proizvod je koncipiran isključivo za pitku vodu!

OPIS SIMBOLA

-  Nemojte koristiti silikon koji sadrži octenu kiselinu!
-  MJERE (pogledaj stranicu 20)
-  DIJAGRAM PROTOKA (pogledaj stranicu 20)
-  Upozorenje na opasnost od vrele površine!
-  ODRŽAVANJE (pogledaj stranicu 19)
Ispravnost nepovratnog ventila mora se redovito provjeravati prema standardu DIN EN 1717 i u skladu sa važećim propisima (najmanje jednom godišnje).
-  REZERVNI DJELOVI (pogledaj stranicu 21)
XXX = Boje
000 = Krom
820 = Brushed Nickel
-  UPOTREBA (pogledaj stranicu 19)
-  ČIŠĆENJE (pogledaj stranicu 22)
-  OZNAKA TESTIRANJA (pogledaj stranicu 21)

GREŠKA	UZROK	OTKLANJANJE
/ Nedovoljno vode	/ Nepovratni ventil se nije vratio u početni položaj / Filter tuša je prljav	/ Zamijenite nepovratni ventil / Očistite filter između tuša i crijeva
/ Protočni bojler ne radi	/ Limiter protoka u ručnom tušu nije odstranjen / Filter tuša je prljav / Nepovratni ventil se nije vratio u početni položaj	/ Odstranite limiter protoka / Očistite filter između tuša i crijeva / Zamijenite nepovratni ventil



⚠ GÜVENLİK UYARILARI

- ⚠ Montaj esnasında ezilme ve kesilme gibi yaralanmaları önlemek için eldiven kullanılmalıdır.
- ⚠ Ürün yalnızca banyo, hijyen ve beden temizliği amaçları doğrultusunda kullanılabilir.
- ⚠ Sıcak ve soğuk su bağlantıları arasında büyük basınç farklılıkları varsa, bu basınç farklılıklarının dengelenmesi gerekir.

MONTAJ AÇIKLAMALARI

- / Montaj işleminden önce ürün nakliye hasarları yönünden kontrol edilmelidir. Montaj işleminden sonra nakliye veya yüzey hasarları için sorumluluk üstlenilmemektedir.
- / Boruların ve armatürün montajı, yıkanması ve kontrolü geçerli normlara göre yapılmalıdır.
- / Ülkelerde geçerli kurulum yönetmeliklerine riayet edilmelidir.

TEKNİK BİLGİLER

İşletme basıncı:	azami 1 MPa
Tavsiye edilen işletme basıncı:	0,1 - 0,5 MPa
Kontrol basıncı:	1,6 MPa (1 MPa = 10 bar = 147 PSI)
Sıcak su sıcaklığı:	azami 70°C
Tavsiye edilen su ısı:	65°C
Termik dezenfeksiyon:	azami 70°C/4 dak

Ürün sadece şebeke suyu için tasarlanmıştır!

SİMGE AÇIKLAMASI

-  Asetik asit içeren silikon kullanmayın!
-  ÖLÇÜLERİ (bakınız sayfa 20)
-  AKIŞ DİYAGRAMI (bakınız sayfa 20)
-  Sıcak yüzeye karşı uyarı!
-  BAKIM (bakınız sayfa 19)
DIN EN 1717 ve ulusal standartlar doğrultusunda Çek valfler düzenli olarak kontrol edilmelidir. (en az yılda bir kez)
-  YEDEK PARÇALAR (bakınız sayfa 21)
XXX = Renkler
000 = Krom
820 = Brushed Nickel
-  KULLANIMI (bakınız sayfa 19)
-  TEMİZLEME (bakınız sayfa 22)
-  KONTROL İŞARETİ (bakınız sayfa 21)

ARIZA	SEBEP	YARDIM
/ Az su geliyor	/ Çek valf çalışmıyor olabilir	/ Çek valfı değiştirin
	/ Duşun süzgeci tıkanmış olabilir	/ El duşu ile hortum arasındaki hortumu yıkayın
/ Şofben çalışmıyor	/ El duşunun içindeki akım limitleyici çıkarılmamış olabilir	/ Akım limitleyiciyi el duşundan çıkartın
	/ Duşun süzgeci tıkanmış olabilir	/ El duşu ile hortum arasındaki hortumu yıkayın
	/ Çek valf çalışmıyor olabilir	/ Çek valfı değiştirin

MONTAJI (bakınız sayfa 17) 

⚠ INSTRUCȚIUNI DE SIGURANȚĂ

- ⚠ La montare utilizați mănuși pentru evitarea contuziunilor și tăierii mâinilor.
- ⚠ Produsul poate fi utilizat doar pentru spălarea, menținerea igienei și curățarea corpului.
- ⚠ Diferențele de presiune mari între alimentarea cu apă rece și apă caldă trebuie echilibrate.

INSTRUCȚIUNI DE MONTARE

- / Înainte de instalare verificați, dacă produsul prezintă deteriorări de transport. După instalare garanția nu acoperă deteriorările de transport și cele de suprafață.
- / Conductele și bateriile trebuie montate, spălate și verificate conform normelor în vigoare.
- / Respectați reglementările referitoare la instalare valabile în țara respectivă.

DATE TEHNICE

Presiune de funcționare:	max. 1 MPa
Presiune de funcționare recomandată:	0,1 - 0,5 MPa
Presiune de verificare:	1,6 MPa (1 MPa = 10 bar = 147 PSI)
Temperatura apei calde:	max. 70°C
Temperatura recomandată a apei calde:	65°C
Dezinfecție termică:	max. 70°C/4 min
Produsul este destinat exclusiv pentru apă potabilă.	

DESCRIEREA SIMBOLURILOR

-  Nu utilizați silicon cu conținut de acid acetic!
-  DIMENSIUNI (vezi pag. 20)
-  DIAGRAMA DE DEBIT (vezi pag. 20)
-  Atenție la suprafața fierbinte!
-  ÎNTREȚINERE (vezi pag. 19)
Supapele anti-retur trebuie verificate regulat conform DIN EN 1717 și standardele naționale sau regionale (cel puțin o dată pe an).
-  PIESE DE SCHIMB (vezi pag. 21)
XXX = Coduri de culori
000 = Crom
820 = Brushed Nickel
-  UTILIZARE (vezi pag. 19)
-  CURĂȚARE (vezi pag. 22)
-  CERTIFICAT DE TESTARE (vezi pag. 21)

DERANJAMENT	CAUZA	MĂSURI DE REMEDIERE
/ Prea puțină apă	/ S-a blocat supapa anti-retur.	/ Schimbați supapa anti-retur.
	/ S-a murdărit garnitura de sită a capătului de duș.	/ Curățați garnitura sită dintre capătul duș și furtun.
/ Boilerul instant nu funcționează.	/ Reductorul nu a fost demontat din dușul de mână.	/ Îndepărtați reductorul din dușul de mână.
	/ S-a murdărit garnitura de sită a capătului de duș.	/ Curățați garnitura sită dintre capătul duș și furtun.
	/ S-a blocat supapa anti-retur.	/ Schimbați supapa anti-retur.

MONTARE (vezi pag. 17) 

⚠ ΥΠΟΔΕΙΞΕΙΣ ΑΣΦΑΛΕΙΑΣ

- ⚠ Για να αποφύγετε τραυματισμούς κατά τη συναρμολόγηση πρέπει να φοράτε γάντια.
- ⚠ Το προϊόν επιτρέπεται να χρησιμοποιείται μόνο σαν μέσο λουτρού, υγιεινής και καθαρισμού του σώματος.
- ⚠ Οι διαφορές της πίεσης μεταξύ της σύνδεσης κρύου και ζεστού νερού θα πρέπει να αντισταθμίζονται.

ΟΔΗΓΙΕΣ ΣΥΝΑΡΜΟΛΟΓΗΣΗΣ

- / Πριν τη συναρμολόγηση πρέπει να εξεταστεί το προϊόν για ζημιές μεταφοράς. Μετά την εγκατάσταση δεν αναγνωρίζονται ζημιές από τη μεταφορά ή επιφανειακές ζημιές.
- / Οι σωλήνες και η μπαταρία πρέπει να τοποθετηθούν σύμφωνα με τα ισχύοντα πρότυπα, να τεθούν υπό πίεση και να δοκιμαστούν.
- / Θα πρέπει να τηρούνται οι οδηγίες εγκατάστασης που ισχύουν σε κάθε κράτος.

ΤΕΧΝΙΚΑ ΧΑΡΑΚΤΗΡΙΣΤΙΚΑ

Λειτουργία πίεσης:	έως 1 MPa
Συνιστώμενη λειτουργία πίεσης:	0,1 - 0,5 MPa
Πίεση ελέγχου:	1,6 MPa (1 MPa = 10 bar = 147 PSI)
Θερμοκρασία ζεστού νερού:	έως 70°C
Συνιστώμενη θερμοκρασία ζεστού νερού:	65°C
Θερμική απολύμανση:	έως 70°C/4 min

Το προϊόν έχει σχεδιαστεί αποκλειστικά για πόσιμο νερό!

ΠΕΡΙΓΡΑΦΗ ΣΥΜΒΟΛΩΝ

-  Μην χρησιμοποιείτε σιλικόνη που περιέχει οξικό οξύ!
-  ΔΙΑΣΤΑΣΕΙΣ (βλ. Σελίδα 20)
-  ΔΙΑΓΡΑΜΜΑ ΡΟΗΣ (βλ. Σελίδα 20)
-  Προειδοποίηση: καυτή επιφάνεια!
-  ΣΥΝΤΗΡΗΣΗ (βλ. Σελίδα 19)
Οι βαλβίδες αντεπιστροφής πρέπει να ελέγχονται τακτικά ως προς τη λειτουργία τους, σύμφωνα με το πρότυπο DIN EN 1717, σε σχέση με τους ισχύοντες εθνικούς ή τοπικούς κανόνες (το ελάχιστο μια φορά το χρόνο).
-  ΑΝΤΑΛΛΑΚΤΙΚΑ (βλ. Σελίδα 21)
XXX = Χρώματα
000 = Επιχρωμωμένο
820 = Brushed Nickel
-  ΧΕΙΡΙΣΜΟΣ (βλ. Σελίδα 19)
-  ΚΑΘΑΡΙΣΜΟΣ (βλ. Σελίδα 22)
-  ΣΗΜΑ ΕΛΕΓΧΟΥ (βλ. Σελίδα 21)

ΒΛΑΒΗ	ΑΙΤΙΑ	ΔΙΟΡΘΩΣΗ
/ Ανεπαρκές νερό	/ Η βαλβίδα αντεπιστροφής δεν γυρίζει πίσω. / Βρώμικη στεγανοποιητική σήτα του καταιονιστήρα	/ Αλλάξτε τη βαλβίδα αντεπιστροφής / Καθαρίστε και, εάν χρειαστεί, αλλάξτε τη στεγανοποιητική σήτα μεταξύ καταιονιστήρα και σπιράλ
/ Ο ταχυθερμοσίφνας δεν ενεργοποιείται	/ Το στραγγαλιστικό πηνίο δεν έχει αποσυναρμολογηθεί από τον καταιονιστήρα χειρός / Βρώμικη στεγανοποιητική σήτα του καταιονιστήρα	/ Καθαρίστε το στραγγαλιστικό πηνίο από τον καταιονιστήρα χειρός / Καθαρίστε και, εάν χρειαστεί, αλλάξτε τη στεγανοποιητική σήτα μεταξύ καταιονιστήρα και σπιράλ
	/ Η βαλβίδα αντεπιστροφής δεν γυρίζει πίσω.	/ Αλλάξτε τη βαλβίδα αντεπιστροφής

ΣΥΝΑΡΜΟΛΟΓΗΣΗ (βλ. Σελίδα 17)

**⚠ VARNOSTNA OPOZORILA**

- ⚠ Pri montaži je treba nositi rokavice, da se preprečijo poškodbe zaradi zmečkanja ali urezov.
- ⚠ Ta izdelek se sme uporabljati le z namenom umivanja, vzdrževanja higiene in telesne nege.
- ⚠ Velike razlike v tlaku med priključkom za mrzlo in priključkom za toplo vodo je potrebno izravnati.

NAVODILA ZA MONTAŽO









- / Pred montažo je treba izdelek preveriti glede morebitnih transportnih poškodb. Po vgradnji transportne ali površinske poškodbe ne bodo več priznane.
- / Cevi in armaturo je treba montirati, izprati in preveriti po veljavnih standardih.
- / Upoštevati je treba pravilnike o inštalacijah, ki veljajo v posamezni državi.

TEHNIČNI PODATKI

Delovni tlak:	maks. 1 MPa
Priporočeni delovni tlak:	0,1 - 0,5 MPa
Preskusni tlak:	1,6 MPa (1 MPa = 10 bar = 147 PSI)
Temperatura tople vode:	maks. 70°C
Priporočena temperatura tople vode:	65°C
Termična dezinfekcija:	maks. 70°C/4 min

Proizvod je zasnovan izključno za sanitarno vodo!

OPIS SIMBOLA

-  Ne smete uporabiti silikona, ki vsebuje ocatno kislino!
-  MERE (glejte stran 20)
-  DIAGRAM PRETOKA (glejte stran 20)
-  Opozorilo pred vročo površino!
-  VZDRŽEVANJE (glejte stran 19)
Delovanje protipovratnega ventila je potrebno v skladu z DIN EN 1717 in skladno z državnimi in regionalnimi določili redno testirati (najmanj enkrat letno).
-  REZERVNI DELI (glejte stran 21)
XXX = Barve
000 = Krom
820 = Brushed Nickel
-  UPRAVLJANJE (glejte stran 19)
-  ČIŠČENJE (glejte stran 22)
-  PRESKUSNI ZNAK (glejte stran 21)

NARAKA	VZROK	POMOČ
/ Malo vode	/ Protipovratni ventil je običal / Filtrirna mrežica prhe je umazana	/ Zamenjajte protipovratni ventil / Očistite filtrirno mrežico med prho in gibko cevjo
/ Pretočni grelnik se ne vklopi	/ Omejevalnik pretoka ni odstranjen iz ročne prhe / Filtrirna mrežica prhe je umazana	/ Odstranite omejevalnik pretoka iz ročne prhe / Očistite filtrirno mrežico med prho in gibko cevjo
	/ Protipovratni ventil je običal	/ Zamenjajte protipovratni ventil

MONTAŽA (glejte stran 17)



△ OHUTUSJUHISED

- △ Kandke paigaldamisel muljumis- ja löikevigastuste vältimiseks kindaid.
- △ Toodet tohib kasutada ainult pesemis-, hügieeni- ja kehahügieeniseesmärkidel.
- △ Kui külma ja kuuma vee ühenduste surve on väga erinev, tuleb need tasakaalustada.

PAIGALDAMISJUHISED

- / Enne paigaldamist tuleb toodet kontrollida transpordikahjustuste osas Pärast paigaldamist ei tunnustata enam transpordi- või pinnakahjustuste kaebuseid.
- / Voolikute ja segisti paigaldamisel, loputamisel ja kontrollimisel tuleb lähtuda kehtivatest normatiividest
- / Vastavas riigis kehtivaid paigalduseeskirju tuleb järgida.

TEHNILISED ANDMED

Töörõhk	maks. 1 MPa
Soovitav töörõhk:	0,1 - 0,5 MPa
Kontrollsurve:	1,6 MPa (1 MPa = 10 baari = 147 PSI)
Kuuma vee temperatuur:	maks. 70°C
Soovitav kuuma vee temperatuur:	65°C
Terminline desinfektsioon:	maks. 70°C / 4 min

Toode on ette nähtud eranditult joogivee jaoks!

SÜMBOLITE KIRJELDUS

 Ärge kasutage äädikhapet sisaldavat silikooni!

 MÕÕTUDE (vt lk 20)

 LÄBIVOOLUDIAGRAMM (vt lk 20)

 Kuum pealispind!

 HOOLDUS (vt lk 19)
Tagasilöögiklappide toimimist tuleb koostöös riiklike ja regionaalsete määrustega regulaarselt kontrollida vastavalt standardile DIN EN 1717 (vähemalt kord aastas).

 VARUOSAD (vt lk 21)
XXX = Värvid
000 = Kroom
820 = Brushed Nickel

 KASUTAMINE (vt lk 19)

 PUHASTAMINE (vt lk 22)

 KONTROLLSERTIFIKAAT (vt lk 21)

RIKE	PÕHIUS	LAHENDUS
/ Vähe vett	/ Tagasilöögiklapp on kinni	/ Tagasilöögiklapp välja vahetada
	/ Duši söelühend must	/ Puhastage duši ja vooliku vaheline söelühend
/ avatud süsteemi boiler ei lülitu sisse	/ Veehulga piirajat ei ole ära võetud	/ Eemaldage veehulga piiraja
	/ Duši söelühend must	/ Puhastage duši ja vooliku vaheline söelühend
	/ Tagasilöögiklapp on kinni	/ Tagasilöögiklapp välja vahetada

PAIGALDAMINE (vt lk 17) 

△ DROŠĪBAS NORĀDES

- △ Montāžas laikā, lai izvairītos no saspiedumiem un iegriezumiem, nepieciešams nēsāt cimdus.
- △ Šo produktu drīkst izmantot tikai, lai mazgātos, higiēnai un ķermeņa tīrīšanai.
- △ Jāizlīdzina spiediena atšķirības starp aukstā un karstā ūdens pievadiem.

NORĀDĪJUMI MONTĀŽAI

- / Pirms montāžas nepieciešams pārbaudīt, vai produktam transportēšanas laikā nav radušies bojājumi. Pēc iebūvēšanas bojājumi, kas radušies transportēšanas laikā, vai virsmas bojājumi netiek atzīti.
- / Caurulvadi un armatūra ir jāuzstāda, jāizskalo un jāpārbauda saskaņā ar spēkā esošajiem standartiem.
- / Jāievēro attiecīgās valstīs spēkā esošās montāžas prasības.

TEHNISKIE DATI

Darba spiediens:	maks. 1 MPa
Ieteicamais darba spiediens:	0,1 - 0,5 MPa
Pārbaudes spiediens:	1,6 MPa (1 MPa = 10 bar = 147 PSI)
Karstā ūdens temperatūra:	maks. 70°C
Ieteicamā karstā ūdens temperatūra:	65°C
Termiskā dezinfekcija:	maks. 70°C / 4 min

Izstrādājums ir paredzēts tikai dzeramajam ūdenim!

SIMBOLU NOZĪME

 Neizmantot silikonu, kas satur etiķskābi!

 IZMĒRUS (skat. lpp. 20)

 CAURPLŪDES DIAGRAMMA (skat. lpp. 20)

 Brīdinājums par karstu virsmu!

 APKOPE (skat. lpp. 19)
Regulāri jāpārbauda pretvārsta funkcija saskaņā ar DIN EN 1717 saistībā ar nacionālajiem vai vietējiem noteikumiem (vismaz vienreiz gadā).

 REZERVES DAĻAS (skat. lpp. 21)
XXX = Krāsu kodi
000 = Hroma
820 = Brushed Nickel

 LIETOŠANA (skat. lpp. 19)

 TĪRĪŠANA (skat. lpp. 22)

 PĀRBAUDES ZĪME (skat. lpp. 21)

TRAUCĒJUMS	IEMESLS	BOJĀJUMU NOVĒRŠANA
/ Maz ūdens	/ Pretvārsts ir iesprūdis	/ Nomainīt pretvārstu
	/ Netīrs dušas filtra blīvējums	/ Izīrīt filtra blīvējumu starp dušu un šļūteni
/ Neieslēdzas caurteces sildītājs	/ Rokas dušā nav demontēts vārsts	/ Izņemt no rokas dušas vārstu
	/ Netīrs dušas filtra blīvējums	/ Izīrīt filtra blīvējumu starp dušu un šļūteni
	/ Pretvārsts ir iesprūdis	/ Nomainīt pretvārstu

MONTĀŽA (skat. lpp. 17) 

△ SIGURNOSNE NAPOMENE

- △ Prilikom montaže se radi sprečavanja prignječenja i posekotina moraju nositi rukavice.
- △ Proizvod sme da se koristi samo za kupanje, tuširanje i ličnu higijenu.
- △ Velika razlika u pritisku između vruće i hladne vode mora biti izbalansirana.

INSTRUKCIJE ZA MONTAŽU









- / Pre montaže se mora proveriti da li je proizvod oštećen pri transportu. Nakon ugradnje se ne priznaju nikakve reklamacije koje se odnose na površinska i transportna oštećenja.
- / Vodovi i armatura moraju biti postavljeni, isprani i testirani prema važećim normama.
- / Treba se pridržavati propisa koji u određenim zemljama važe za instalacije.

TEHNIČKI PODACI

Radni pritisak:	maks. 1 MPa
Preporučeni radni pritisak:	0,1 - 0,5 MPa
Probni pritisak:	1,6 MPa (1 MPa = 10 bar = 147 PSI)
Temperatura vruće vode:	maks. 70°C
Preporučena temperatura vruće vode:	65°C
Termička dezinfekcija:	maks. 70°C/4 min

Proizvod je koncipiran isključivo za pijaću vodu!

OPIS SIMBOLA

-  Nemojte koristiti silikon koji sadrži sirćetnu kiselinu!
-  MERE (vidi stranu 20)
-  DIJAGRAM PROTOKA (vidi stranu 20)
-  Upozorenje na opasnost od vrele površine!
-  ODRŽAVANJE (vidi stranu 19)
Ispravno funkcionisanje nepovratnog ventila se mora redovno proveravati prema standardu DIN EN 1717 i u skladu s važećim nacionalnim ili regionalnim propisima (najmanje jednom godišnje).
-  REZERVNI DELOVI (vidi stranu 21)
XXX = Oznake boja
000 = Hrom
820 = Brushed Nickel
-  RUKOVANJE (vidi stranu 19)
-  ČIŠĆENJE (vidi stranu 22)
-  ISPITNI ZNAK (vidi stranu 21)

SMETNJA	UZROK	POMOĆ
/ Nedovoljno vode	/ Nepovratni ventil se nije vratio u početni položaj	/ Zamenite nepovratni ventil
	/ Mrežasta zaptivka tuša je prljava	/ Očistite mrežastu zaptivku između tuša i crijeva
/ Protočni bojler ne radi	/ Prigušnica u ručnom tušu nije odstranjena	/ Odstranite prigušnicu iz ručnog tuša
	/ Mrežasta zaptivka tuša je prljava	/ Očistite mrežastu zaptivku između tuša i crijeva
	/ Nepovratni ventil se nije vratio u početni položaj	/ Zamenite nepovratni ventil



△ SIKKERHETSHENVISNINGER

- △ Bruk hansker under montasjen for å unngå klem- og kuttskader.
- △ Produktet skal kun brukes for bade-, hygiene- og kroppshygiene.
- △ Store trykkdifferanser mellom kaldt- og varmtvannstilkoblinger skal utlignes.





MONTAGEHENVISNINGER

- / Før montasjen skal produktet sjekkes for transportskader. Etter monteringen aksepteres ikke noen transport- eller overflateskader.
- / Ledningene og armaturen skal monteres, spyles og sjekkes iht. de gyldige normer.
- / Gjeldende retningslinjer for rørleggerarbeid i de enkelte land skal følges.

TEKNISKE DATA

Driftstrykk	maks. 1 MPa
Anbefalt driftstrykk:	0,1 - 0,5 MPa
Prøvetrykk	1,6 MPa (1 MPa = 10 bar = 147 PSI)
Varmtvannstemperatur	maks. 70°C
Anbefalt temperatur for varmt vann	65°C
Termisk desinfisering:	maks. 70°C/4 min
Produktet er utelukkende designet for drikkevann!	

SYMBOLBESKRIVELSE

-  Ikke bruk silikon som inneholder eddiksyre!
-  MÅL (se side 20)
-  GJENNOMSTRØMNINGSDIAGRAM (se side 20)
-  Varsel pga. het overflate!
-  VEDLIKEHOLD (se side 19)
Funksjonen til returløpssperren skal iht. DIN EN 1717 og i samsvar med de nasjonale og lokale forskrifter sjekkes regelmessig (minst en gang i året).
-  SERVICEDELER (se side 21)
XXX = Fargekode
000 = Krom
820 = Brushed Nickel
-  BETJENING (se side 19)
-  RENGJØRING (se side 22)
-  PRØVEMERKE (se side 21)

FEIL	ÅRSAK	FEILRETTELSE
/ Lite vann	/ Returløpstopper sitter fast	/ Returløpstopper byttes
	/ Dusjens silpakning er skitten	/ Silpakning mellom dusj og slangen rengjøres
/ gjennomstrømningsvarmer innkobler ikke.	/ Drossel til hånddusjen ikke fjernet	/ Drossel fjernes fra hånddusjen
	/ Dusjens silpakning er skitten	/ Silpakning mellom dusj og slangen rengjøres
	/ Returløpstopper sitter fast	/ Returløpstopper byttes



▲ УКАЗАНИЯ ЗА БЕЗОПАСНОСТ

- ▲ При монтажа трябва да се носят ръкавици, за да се избегнат наранявания поради притискане или порязване.
- ▲ Позволено е използването на продукта само за къпане, хигиена и цели на почистване на тялото.
- ▲ Големите разлики в налягането между изводите за студената и топлата вода трябва да се изравняват.

УКАЗАНИЯ ЗА МОНТАЖ

- / Преди монтажа продуктът трябва да се провери за транспортни щети. След монтажа не се признават транспортни или повърхностни щети.
- / Тръбопроводите и арматурата трябва да се монтират, промият и проверят в съответствие с валидните норми.
- / Трябва да бъдат спазвани валидните в съответните страни предписания за инсталиране.

ТЕХНИЧЕСКИ ДАННИ

Работно налягане:	макс. 1 МПа
Препоръчително работно налягане:	0,1 - 0,5 МПа
Контролно налягане:	1,6 МПа
	(1 МПа = 10 bar = 147 PSI)
Температура на горещата вода:	макс. 70°C
Препоръчителна температура на горещата вода:	65°C
Термична дезинфекция:	макс. 70°C/4 мин

Продуктът е разработен само за питейна вода!

ОПИСАНИЕ НА СИМВОЛИТЕ

 Не използвайте силикон, съдържащ оцетна киселина!

 РАЗМЕРИ (вижте стр. 20)

 ДИАГРАМА НА ПОТОКА (вижте стр. 20)

 Предупреждение за гореща повърхност!

 ПОДДРЪЖКА (вижте стр. 19)
Съгласно DIN EN 1717 функционирането на приспособленията за предотвратяване на обратния поток трябва редовно да се проверява в съответствие с националните или регионални изисквания (поне веднъж годишно).

 СЕРВИЗНИ ЧАСТИ (вижте стр. 21)

XXX = Цветово кодиране
000 = Хром
820 = Brushed Nickel

 ОБСЛУЖВАНЕ (вижте стр. 19)

 ПОЧИСТВАНЕ (вижте стр. 22)

 КОНТРОЛЕН ЗНАК (вижте стр. 21)

НЕИЗПРАВНОСТ	ПРИЧИНА	ПОМОЩ
/ Малко вода	/ Здравно стоящо приспособление за предотвратяване на обратния поток	/ Смяна на приспособлението за предотвратяване на обратния поток
	/ Замърсено е уплътнението с цедка на разпръсквателя	/ Почистете уплътнението с цедка между разпръсквателя и маркуча
/ Проточният нагревател не се включва	/ Дроселът в ръчния разпръсквател не е демонтиран	/ Отстранете дросела от ръчния разпръсквател
	/ Замърсено е уплътнението с цедка на разпръсквателя	/ Почистете уплътнението с цедка между разпръсквателя и маркуча
	/ Здравно стоящо приспособление за предотвратяване на обратния поток	/ Смяна на приспособлението за предотвратяване на обратния поток

МОНТАЖ (вижте стр. 17) 

▲ UDHËZIME SIGURIE

- ▲ Për të evituar lëndimet e pickimeve ose të prerjeve gjatë procesit të montimit duhet që të vishni doreza.
- ▲ Produkti duhet të përdoret vetëm qëllimet e banjave, të higjienës dhe të larjes së trupit.
- ▲ Ndryshimet e mëdha të presionit mes lidhjeve të ujit të ftohtë dhe atij të ngrohtë duhen ekuilibruar.

UDHËZIME PËR MONTIMIN

- / Përpara montimit duhet që produkti të kontrollohet për dëmtime nga transporti. Pas instalimit nuk do të njihet asnjë dëmtim nga transporti ose dëmtim i sipërfaqes.
- / Tubacionet dhe rubinetet duhet që të montohen, të shpëlahen dhe të kontrollohen sipas standardeve në fuqi
- / Duhet të respektohen linjat udhëzuese të instalimit, të vlefshme për vendet respektive.

TË DHËNA TEKNIKE

Presioni gjatë punës	макс. 1 МПа
Presioni i rekomanduar:	0,1 - 0,5 МПа
Presioni për provë:	1,6 МПа
	(1 МПа = 10 bar = 147 PSI)
Температура e ujit të ngrohtë	макс. 70°C
Температура e rekomanduar e ujit të ngrohtë:	65°C
Dezinfektim Termik:	макс. 70°C/4 min

Produkti është projektuar ekskluzivisht për ujë të pijshëm!

PËRSHKRIMI I SIMBOLIT

 Mos përdorni silikon që në përbërje ka acid acetik.

 PËRMASAT (shih faqen 20)

 DIAGRAMI I QARKULLIMIT (shih faqen 20)

 Paralajmërimi për sipërfaqen e nxehtë!

 MIRËMBAJTJA (shih faqen 19)
Penguesit e rrjedhjes në drejtim të kundërt duhen kontrolluar rregullisht në bazë të normave DIN EN 1717 konform normave nacionale dhe regionale (së paku një herë në vit).

 PJESËT E SERVISIT (shih faqen 21)

XXX = Kodimi me anë të ngjyrave
000 = Krom
820 = Brushed Nickel

 PËRDORIMI (shih faqen 19)

 PASTRIMI (shih faqen 22)

 SHENJA E KONTROLLIT (shih faqen 21)

DEM TIM	SHKAKU	NDIHME
/ Pak ujë	/ Penguesi i rrjedhjes mbrapsht te ujit qendron i fiksuar	/ Kembeni penguesin e rrjedhjes mbrapsht te ujit
	/ Gomina hermetizuese e pajisjes me papasterti	/ Pastroni gominen e sites midis pajisjes dhe tubit
/ Ngrohesi i ujit nuk ndizet.	/ Rregulluesi i ujit në tubacione nuk është i hequr nga spërkatësja	/ Hiqni rregulluesin e ujit në tubacione nga spërkatësja
	/ Gomina hermetizuese e pajisjes me papasterti	/ Pastroni gominen e sites midis pajisjes dhe tubit
	/ Penguesi i rrjedhjes mbrapsht te ujit qendron i fiksuar	/ Kembeni penguesin e rrjedhjes mbrapsht te ujit

MONTIMI (shih faqen 17) 

⚠️ تنبيهات الأمان

- ⚠️ يجب إرتداء قفازات لليد أثناء التركيب لتجنب حدوث أخطار الإنحشار أو الجروح.
- ⚠️ لا يجب استخدام المنتج إلا في أغراض الاستحمام والأغراض الصحية وأغراض تنظيف الجسم.
- ⚠️ يجب أن يكون تيار الماء الساخن والماء البارد متعادلين في الضغط.

تعليمات التركيب

- / قبل القيام بعملية التركيب، يجب فحص المنتج للتأكد من خلوه من أية تلفيات ناتجة عن النقل. يعد القيام بعملية التركيب، لن يتم الاعتراف بوجود أية تلفيات سطحية أو تلفيات ناتجة عن عملية النقل.
- / يجب تركيب وغسيل واختبار التوصيلات وخلطات المياه طبقاً للمعايير السارية.
- / يجب مراعاة القواعد الخاصة بالتركيب وأعمال السباكة وفقاً للوائح الخاصة بكل بلد.

المواصفات الفنية

- ضغط التشغيل: الحد الأقصى 1 ميجاباسكال
- ضغط التشغيل الموصى به: 0,1 - 0,5 ميجاباسكال
- ضغط الاختبار: 1,6 ميجاباسكال
- (1 ميجاباسكال = 10 بار = PSI 147)
- درجة حرارة الماء الساخن: الحد الأقصى 70°C
- درجة الحرارة الموصى بها للماء الساخن: 65°C
- تعقيم حراري: الحد الأقصى 4/70°C الدقيقة
- المنتج مخصص فقط لماء الشرب!

وصف الرمز

هام! لا تستخدم السليكون الذي يحتوي على أحماض! 

أبعاد (راجع صفحة 20) 

رسم للصرف (راجع صفحة 20) 

سطح ساخن! 

الصيانة (راجع صفحة 19) 

يجب فحص صمام عدم الرجوع بصفة منتظمة حسب المواصفة DIN 1717 EN وذلك طبقاً للوائح الوطنية أو الإقليمية (مرة واحد سنوياً على الأقل).

قطع الغيار (راجع صفحة 21) 

الألوان = XXX
كروم = 000
Brushed Nickel = 820

التشغيل (راجع صفحة 19) 

التنظيف (راجع صفحة 22) 

شهادة اختبار (راجع صفحة 21) 

العطل	السبب	العلاج والإصلاح
/ الماء غير كافٍ	/ صمام منع الرجوع ثابت ولا يتحرك	/ قم بتغيير صمام منع الرجوع
/ سخان الفوري لا يعمل	/ سدادة مصفاة الدش متسخة	/ نظف سدادة المصفاة بين الدش والخرطوم
/ محدّد التدفق غير مخلوع من الدش	/ محدّد التدفق غير مخلوع من الدش	/ انزع محدّد التدفق من الدش
/ سدادة مصفاة الدش متسخة	/ سدادة مصفاة الدش متسخة	/ نظف سدادة المصفاة بين الدش والخرطوم
/ صمام منع الرجوع ثابت ولا يتحرك	/ صمام منع الرجوع ثابت ولا يتحرك	/ قم بتغيير صمام منع الرجوع

التركيب (راجع صفحة 17) 

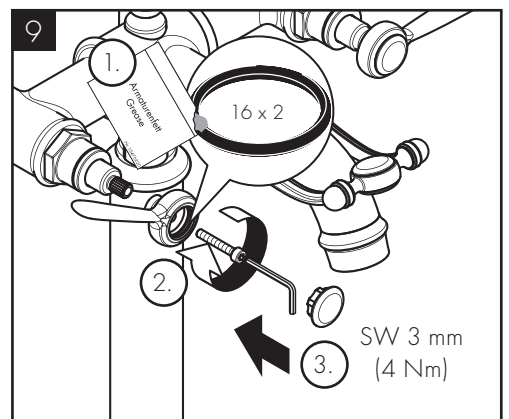
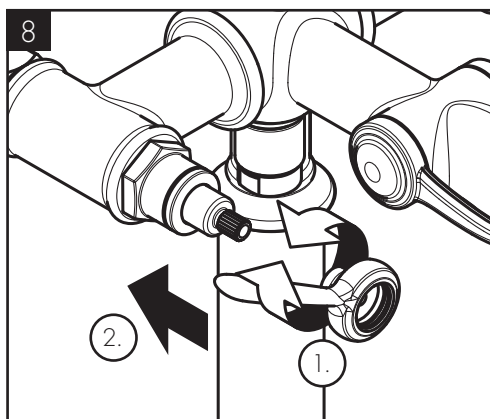
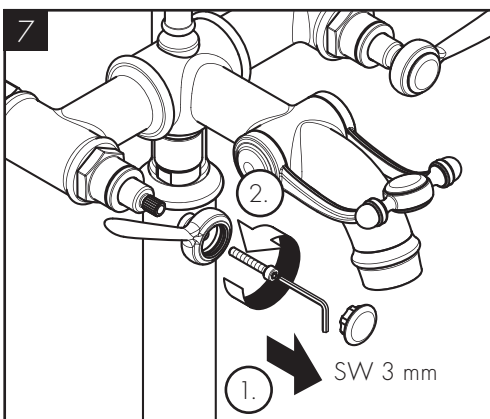
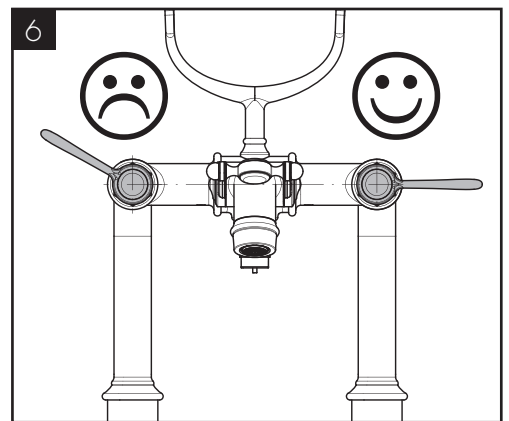
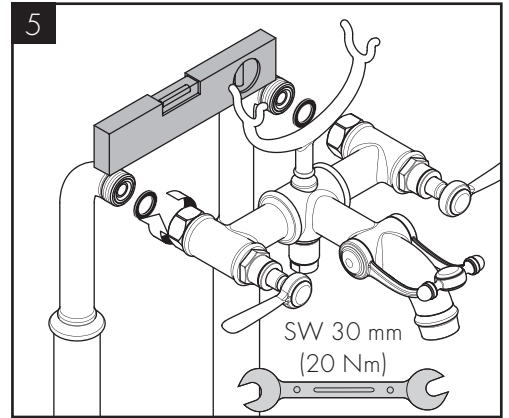
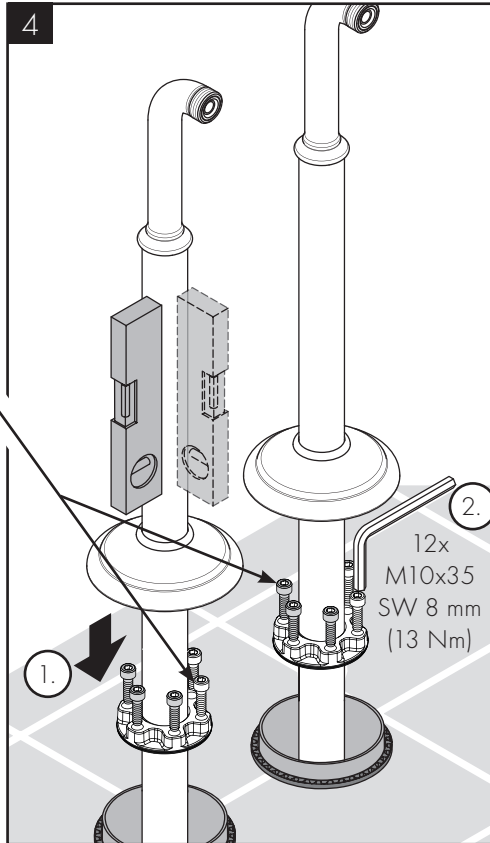
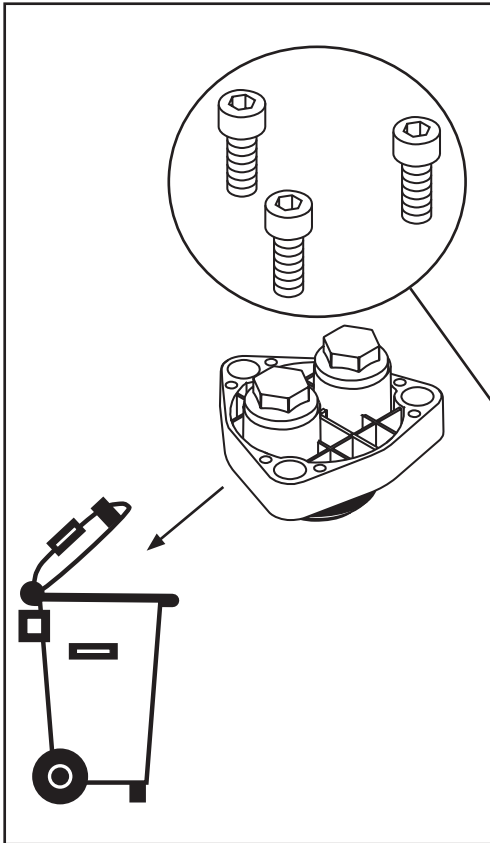
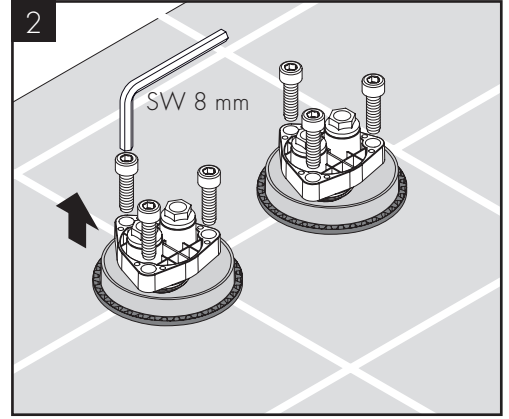
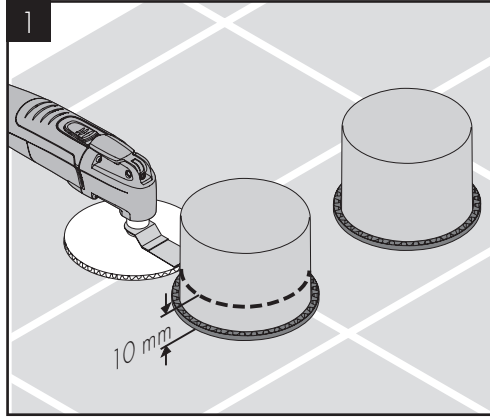
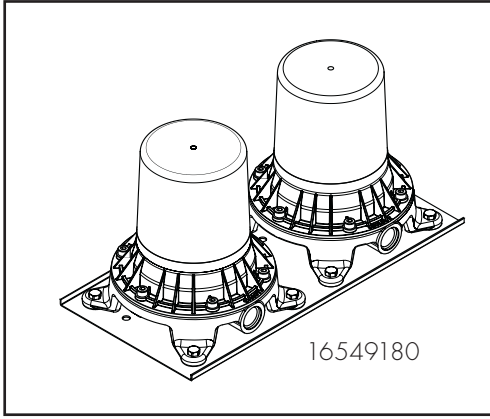

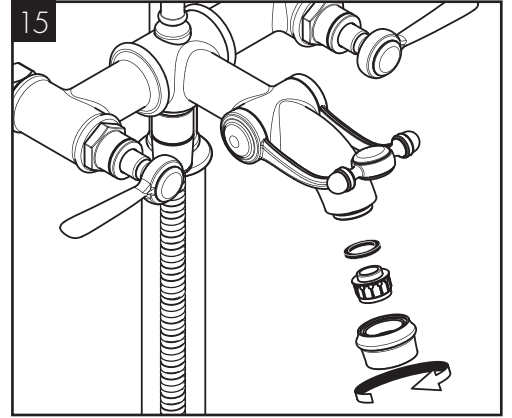
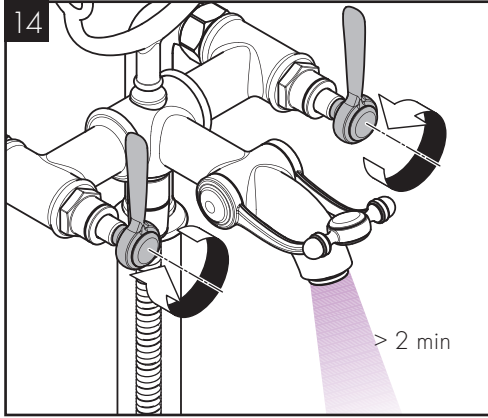
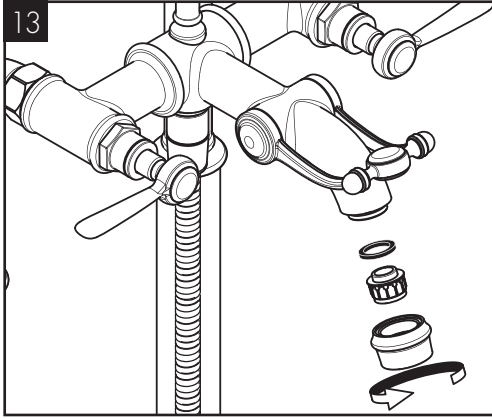
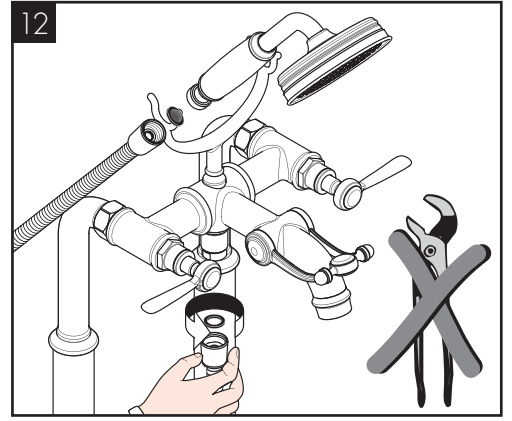
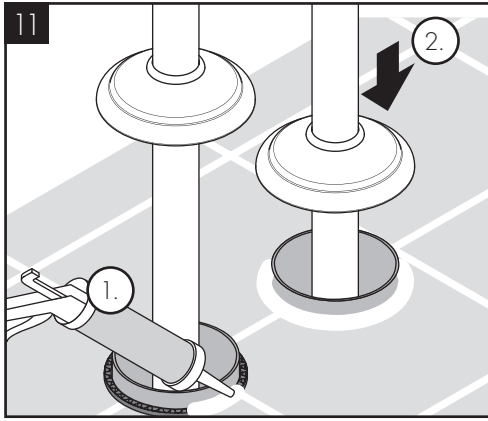
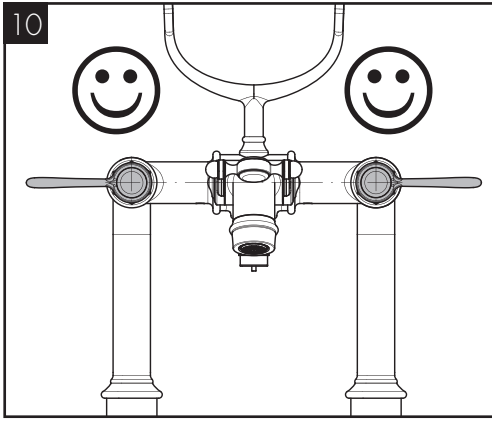

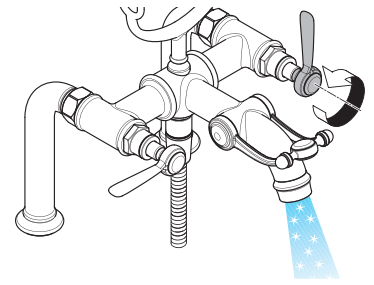
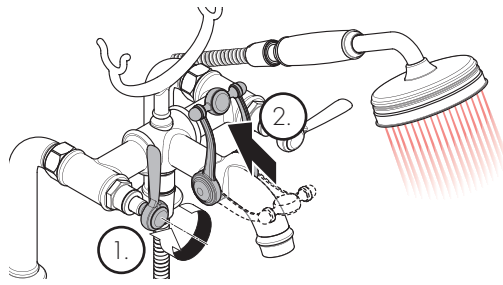
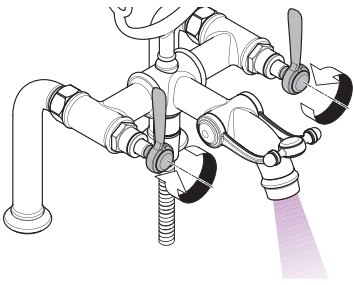

öffnen / ouvert / open / aperto / abierto / open / åbne / abrir / otworzyć / otevřít / otvorit / 开 / открыть / nyitás /
 avaaminen / öppna / atidaryti / Otvaranje / açmak / deschide / ανοικτό / odpreti / avage / atvērt / otvoriti / åpne /
 отваряне / hare / حنف

kalt / froid / cold / freddo / frío / koud / koldt / fría /
 zimna / studená / studená / 冷 / холодная / hideg / kylmä /
 kallt / šaltas / Hladno / soğuk / rece / κρύο / mrzlo / külm /
 auksts / hladno / kaldt / студено / i ftohtë / درياء

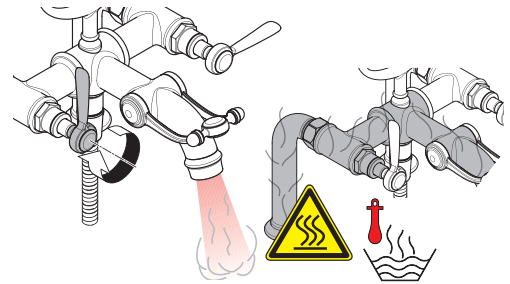
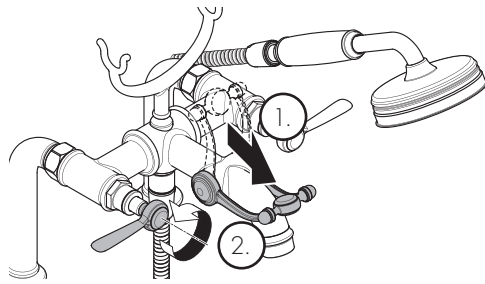
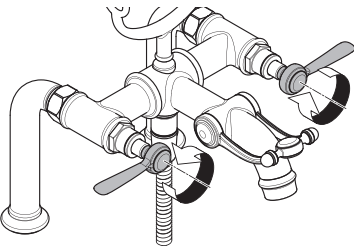

schließen / fermé / close / chiudere / cerrar / sluiten / lukke / fechar / zamknąć / zavřít / uzavrieť / 关 / закрыть / bezárás /
 sulkeminen / stänga / uždaryti / Zatvaranje / kapatmak / închide / κλειστό / zapreti / sulgege / aizvērt / zatvori / lukke /
 затваряне / mbylle / قلاغا

warm / chaud / hot / caldo / caliente / varm / varmt /
 quente / ciepla / teplá / teplá / 热 / горячая / meleg /
 lämmin / varmt / karštas / Vruća voda / sıcak / cald / ζεστό /
 toplo / kuum / karsts / topla / varm / тепло / i ngrohtë / نخلص

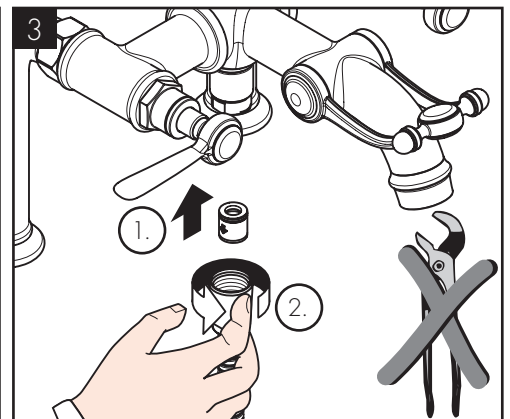
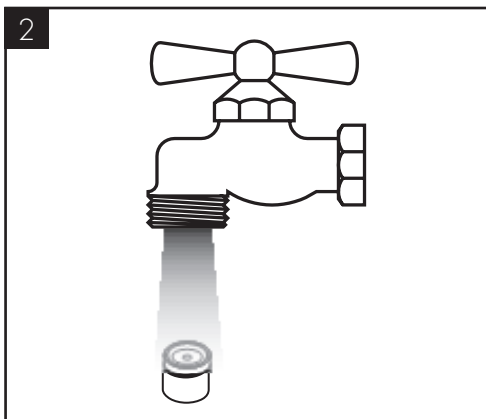
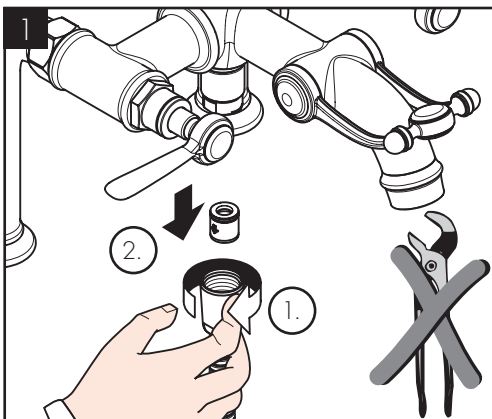



AXOR Montreux
16553XXX

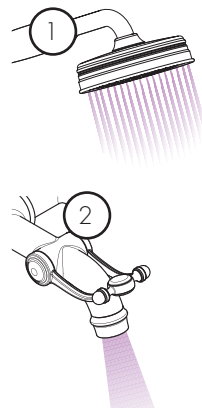
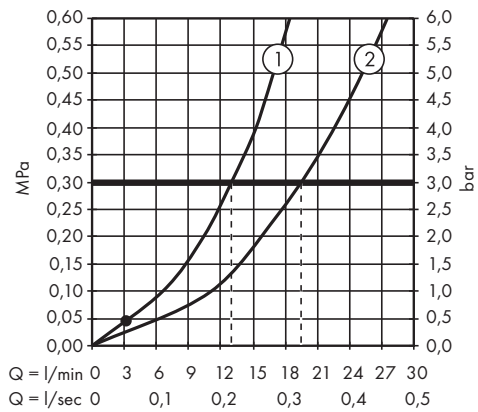
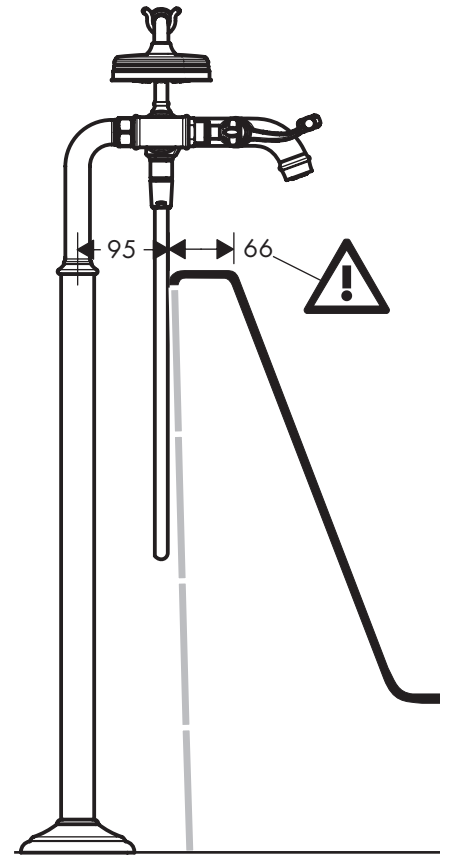
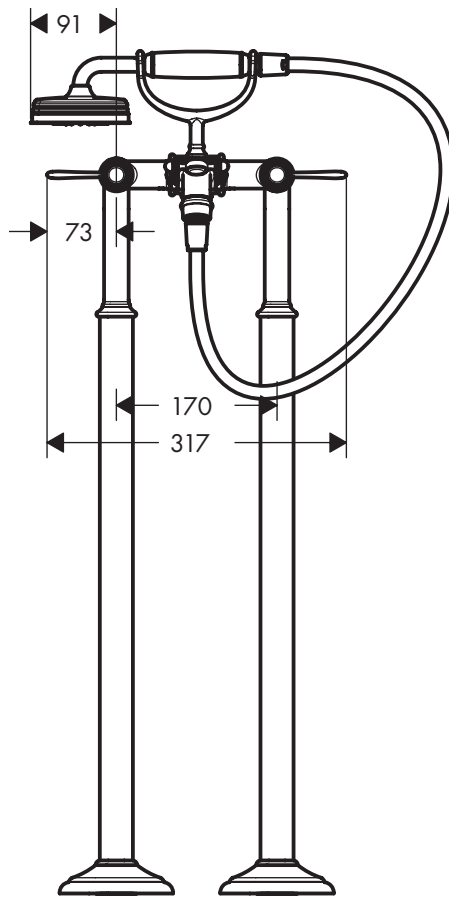
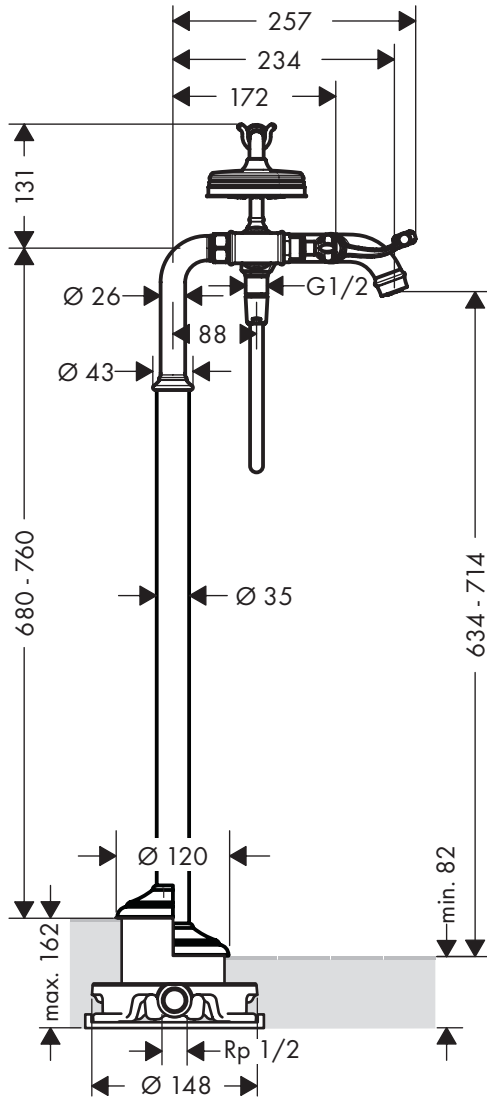



AXOR Montreux
16553XXX

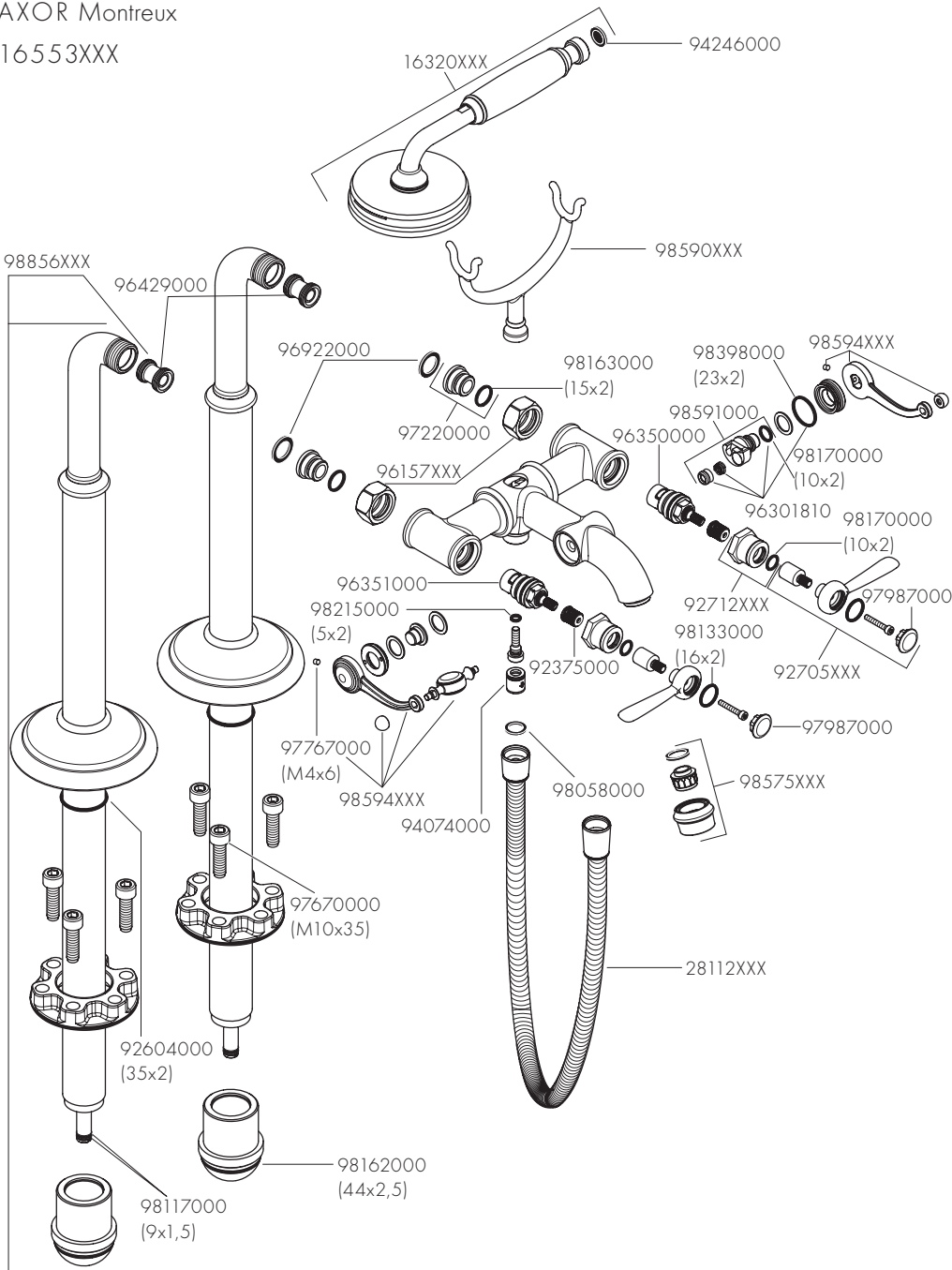

P-IX

DVGW

SVGW

ACS

WRAS



ETA



GODKENDT
TIL DRILLEKAVAND

16552XXX P-IX 9087/ICB



hansgrohe

DIN 4109

P-IX 9087/ICB

LGAD
Landesgesundheitsamt



DE / Reinigungsempfehlung / Garantie / Kontakt
 FR / Recommandation pour le nettoyage / Garanties / Contact
 EN / Cleaning recommendation / Warranty / Contact
 IT / Raccomandazione di pulizia / Garanzia / Contatto
 ES / Recomendaciones para la limpieza / Garantía / Contacto
 NL / Aanbevelingen inzake reiniging / Garantie / Contact
 DK / Rensning, anbefaling / Garanti / Kontakt
 PT / Recomendações de limpeza / Garantia / Contacto
 PL / Zalecenie dotyczące pielęgnacji / Gwarancja / Kontakt
 CS / Doporučení k čištění / Záruka / Kontakt
 SK / Odporúčania pre čistenie / Záruka / Kontakt
 ZH / 清洁指南 / 担保 / 接触
 RU / Рекомендации по очистке / Гарантия / Контакты
 HU / Tisztítási tanácsok / Garancia / érintkezés
 FI / Puhdistussuositus / Takuu / Kosketus
 SV / Rengöringsrekommendationer / Garanti / Contacto
 LT / Valymo rekomendacijos / Garantija / Kontaktai
 HR / Preporuke za čišćenje / Garancija / Kontakt
 TR / Temizleme önerisi / Garanti / Temas
 RO / Recomandări pentru curățare / Garanție / Contact
 EL / Σύσταση καθαρισμού / Εγγύηση / επαφή
 SL / Priporočilo za čiščenje / Garancija / Kontakt
 ET / Puhastussuovitused / Garantii / Kontakt
 LV / Tīrīšanas ieteikumi / Garantija / Kontakti
 SR / Preporuke za čišćenje / Garancija / Kontakt
 NO / Anbefaling for rengjøring / Garanti / Kontakt
 BG / Препоръка за почистване / Гаранция / Контакт
 SQ / Këshilla rreth pastrimit / Garancia / Kontakt
 KO / 세정시 권장사항 / 품질보증 / 접촉
 AR / توصيات التنظيف / الضمان (الولايات المتحدة الأمريكية) / اتصال

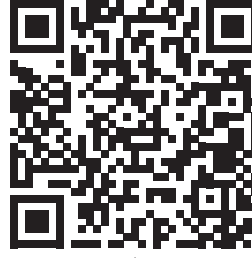

[www.axor-design.com/
cleaning-recommendation](http://www.axor-design.com/cleaning-recommendation)

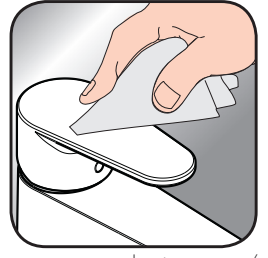

[www.axor-design.com/
cleaning-recommendation](http://www.axor-design.com/cleaning-recommendation)



[www.axor-design.com/
cleaning-recommendation](http://www.axor-design.com/cleaning-recommendation)



[www.axor-design.com/
cleaning-recommendation](http://www.axor-design.com/cleaning-recommendation)

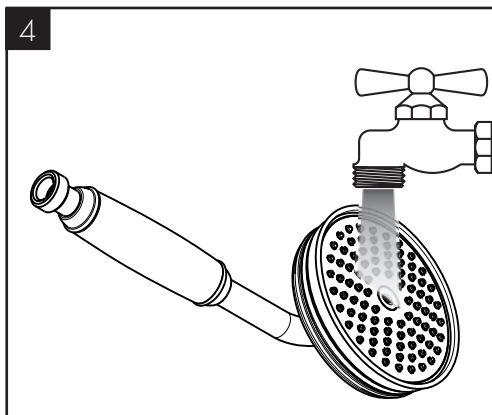
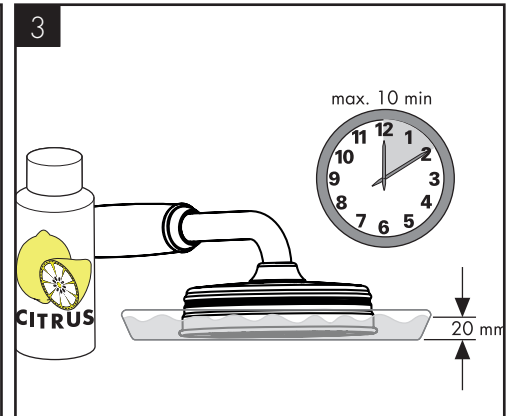
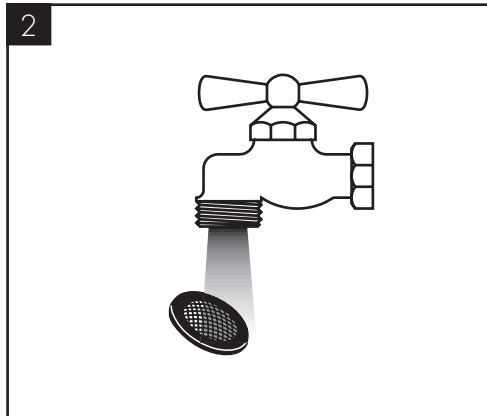
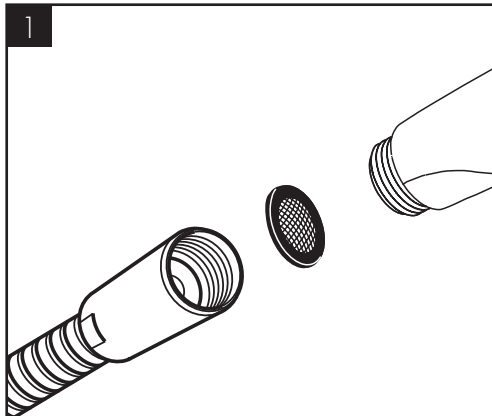

AXOR

AXOR / Hansgrohe SE
Austraße 5-9
77761 Schiltach
Deutschland

info@axor-design.com
axor-design.com

09/2018
9.01224.01