

DE	Gebrauchsanleitung / Montageanleitung	2
FR	Mode d'emploi / Instructions de montage	3
EN	Instructions for use / assembly instructions	4
IT	Istruzioni per l'uso / Istruzioni per Installazione	5
ES	Modo de empleo / Instrucciones de montaje	6
NL	Gebruiksaanwijzing / Handleiding	7
DK	Brugsanvisning / Monteringsvejledning	8
PT	Instruções para uso / Manual de Instalação	9
PL	Instrukcja obsługi / Instrukcja montażu	10
CS	Návod k použití / Montážní návod	11
SK	Návod na použitie / Montážny návod	12
ZH	用户手册 / 组装说明	13
RU	Руководство пользователя / Инструкция по монтажу	14
HU	Használati útmutató / Szerelési útmutató	15
FI	Käyttöohje / Asennusohje	16
SV	Bruksanvisning / Monteringsanvisning	17
LT	Vartotojo instrukcija / Montavimo instrukcijos	18
HR	Upute za uporabu / Uputstva za instalaciju	19
TR	Kullanım kılavuzu / Montaj kılavuzu	20
RO	Manual de utilizare / Instrucțiuni de montare	21
EL	Οδηγίες χρήσης / Οδηγία συναρμολόγησης	22
SL	Navodilo za uporabo / Navodila za montažo	23
ET	Kasutusjuhend / Paigaldusjuhend	24
LV	Lietošanas pamācība / Montāžas instrukcija	25
SR	Uputstvo za upotrebu / Uputstvo za montažu	26
NO	Bruksanvisning / Montasjeveiledning	27
BG	Инструкция за употреба / Ръководство за монтаж	28
SQ	Udhëzuesi i përdorimit / Udhëzime rreth montimit	29
AR	دليل الاستخدام / تعليمات التجميع	30

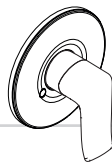

Talis E²
31636000
31687000



Metris
31686000



Focus E
31766000

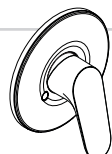

Focus
31966000
31967XXX
37967007

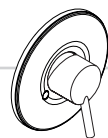

Talis S
32635000

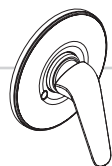

Novus
71067000
71068000



Logis
71606000
71666000



Talis E
71766000



Talis S
72606000



Ihr Online-Fachhändler für:

hansgrohe

- Kostenlose und individuelle Beratung
- Hochwertige Produkte
- Kostenloser und schneller Versand

- TOP Bewertungen
- Exzelerter Kundenservice
- Über 20 Jahre Erfahrung



E-Mail: info@unidomo.de | Tel.: 04621 - 30 60 89 0 | www.unidomo.de



Sicherheitshinweise

- Bei der Montage müssen zur Vermeidung von Quetsch- und Schnittverletzungen Handschuhe getragen werden.
- Das Produkt darf nur zu Bade-, Hygiene- und Körperreinigungszwecken eingesetzt werden.
- Große Druckunterschiede zwischen den Kalt- und Warmwasseranschlüssen müssen ausgeglichen werden.

Montagehinweise

- Vor der Montage muss das Produkt auf Transportschäden untersucht werden. Nach dem Einbau werden keine Transport- oder Oberflächenschäden anerkannt.
- Die Leitungen und die Armatur müssen nach den gültigen Normen montiert, gespült und geprüft werden.

Technische Daten

Betriebsdruck:	max. 1 MPa
Empfohlener Betriebsdruck:	0,1 - 0,5 MPa
Prüfdruck:	1,6 MPa
(1 MPa = 10 bar = 147 PSI)	
Heißwassertemperatur:	max. 70 °C
Empfohlene Heißwassertemperatur:	65 °C
Thermische Desinfektion:	max. 70 °C / 4 min

Das Produkt ist ausschließlich für Trinkwasser konzipiert!

Symbolerklärung



Kein essigsäurehaltiges Silikon verwenden!



Justierung(siehe Seite 32)

Einstellen der Warmwasserbegrenzung. In Verbindung mit Durchlauferhitzern ist eine Warmwassersperre nicht zu empfehlen.



Maße (siehe Seite 33)



Durchflussdiagramm

(siehe Seite 34)

Freier Durchfluss bei 0,3 MPa:



Bedienung (siehe Seite 34)



Serviceteile (siehe Seite 35)

XXX = Farbcodierung

000 = chrom

250 = brushed gold-optik

340 = brushed black chrome



Reinigung (siehe beiliegende Broschüre)



Prüfzeichen (siehe Seite 40)

Störung

Ursache

Abhilfe

Armatur schwergängig

- Kartusche defekt, verkalkt

- Kartusche austauschen

Armatur tropft

- Kartusche defekt

- Kartusche austauschen

Zu niedrige Warmwassertemperatur, kein Kaltwasser. Durchlauferhitzer springt an, wenn Kaltwasser angewählt wird.

- Warmwasserbegrenzung falsch eingestellt

- Warmwasserbegrenzung einstellen

- Kreuzfluss



- Kartusche austauschen



Montage siehe Seite 31



Consignes de sécurité

-  Lors du montage, porter des gants de protection pour éviter toute blessure par écrasement ou coupure.
-  Le produit ne doit servir qu'à se laver et à assurer l'hygiène corporelle.
-  Il est conseillé d'équilibrer les pressions de l'eau chaude et froide.

Instructions pour le montage

- Avant son montage, s'assurer que le produit n'a subi aucun dommage pendant le transport. Après le montage, tout dommage de transport ou de surface ne pourra pas être reconnu.
- Les conduites et la robinetterie doivent être montés, rincés et contrôlés selon les normes en vigueur.

Informations techniques

Pression de service autorisée:	max. 1 MPa
Pression de service conseillée:	0,1 - 0,5 MPa
Pression maximum de contrôle:	1,6 MPa
(1 MPa = 10 bar = 147 PSI)	
Température d'eau chaude:	max. 70 °C
Température recommandée:	65 °C
Désinfection thermique:	max. 70 °C / 4 min

Le produit est exclusivement conçu pour de l'eau potable!

Description du symbole



Ne pas utiliser de silicone contenant de l'acide acétique!



Étalonnage (voir pages 32)

Réglage de la limitation d'eau chaude. En liaison avec les chauffe-eau, un blocage de l'eau chaude n'est pas recommandable.



Dimensions (voir pages 33)

Diagramme du débit

(voir pages 34)

Débit libre à 0,3 MPa:



Instructions de service (voir pages 34)



Pièces détachées (voir pages 35)

XXX = Couleurs

000 = chromé

250 = brushed gold-optic

340 = brushed black chrome



Nettoyage (voir la brochure ci-jointe)



Classification acoustique et débit (voir pages 40)

Dysfonctionnement	Origine	Solution
Durété de fonctionnement	- Cartouche défectueuse, entartrée	- Changer la cartouche
Le mitigeur goutte	- Cartouche défectueuse	- Changer la cartouche
Température d'eau chaude trop basse, pas d'eau froide. Le chauffe-eau instantané met en route quand on puise de l'eau froide.	- Limiteur de température mal positionné - Flux inversé	- Positionner le limiteur de température - Changer la cartouche



Montage voir pages 31



Safety Notes

- ⚠ Gloves should be worn during installation to prevent crushing and cutting injuries.
- ⚠ The product may only be used for bathing, hygienic and body cleaning purposes.
- ⚠ The hot and cold supplies must be of equal pressures.

Installation Instructions

- Prior to installation, inspect the product for transport damages. After it has been installed, no transport or surface damage will be honoured.
- The pipes and the fixture must be installed, flushed and tested as per the applicable standards.

Technical Data

Operating pressure:	max. 1 MPa
Recommended operating pressure:	0,1 - 0,5 MPa
Test pressure:	1,6 MPa
(1 MPa = 10 bar = 147 PSI)	
Hot water temperature:	max. 70 °C
Recommended hot water temp.:	65 °C
Thermal disinfection:	max. 70 °C / 4 min

The product is exclusively designed for drinking water!

Symbol description



Do not use silicone containing acetic acid!



Adjustment(see page 32)

To adjust the hot water limiter. Using a hot water limiter in combination with a continuous flow water heater is not recommended.



Dimensions (see page 33)



Flow diagram

(see page 34)

Rate of flow by 0,3 MPa:



Operation (see page 34)



Spare parts (see page 35)

XXX = Colors

000 = chrome plated

250 = brushed gold-optic

340 = brushed black chrome



Cleaning (see enclosed brochure)



Test certificate (see page 40)



Fault	Cause	Remedy
Mixer stiff	- Cartridge defective, calcified	- Exchange cartridge
Mixer dripping	- Cartridge defective	- Exchange cartridge
Hot water temperature too low, no cold water. Instantaneous water heater starts up when cold water is selected.	- Hot water limiter incorrectly set	- Set hot water limiter
	- Crossflow	- Exchange cartridge



Assembly see page 31



Indicazioni sulla sicurezza

-  Durante il montaggio, per evitare ferite da schiacciamento e da taglio bisogna indossare guanti protettivi.
-  Il prodotto deve essere utilizzato esclusivamente per fare il bagno e per l'igiene del corpo.
-  Attenzione! Compensare le differenze di pressione tra i collegamenti dell'acqua fredda e dell'acqua calda.

Istruzioni per il montaggio

- Prima del montaggio è necessario controllare che non ci siano stati danni durante il trasporto. Una volta eseguito il montaggio, non verranno riconosciuti eventuali danni di trasporto o delle superfici.
- Montare, lavare e controllare tubature e rubinetteria rispettando le norme correnti.

Dati tecnici

Pressione d'uso:	max. 1 MPa
Pressione d'uso consigliata:	0,1 - 0,5 MPa
Pressione di prova:	1,6 MPa
(1 MPa = 10 bar = 147 PSI)	
Temperatura dell'acqua calda:	max. 70 °C
Temp. dell'acqua calda consigliata:	65 °C
Disinfezione termica:	max. 70 °C / 4 min

Il prodotto è concepito esclusivamente per acqua potabile!

Descrizione simbolo



Non utilizzare silicone contenente acido acetico!



Taratura (vedi pagg. 32)

Regolazione del limitatore di erogazione d'acqua calda. Un limitatore di erogazione di acqua calda in combinazione con le caldaie istantanee non è consigliabile.



Ingombri (vedi pagg. 33)

Diagramma flusso

(vedi pagg. 34)

Portata a 0,3 MPa:



Procedura (vedi pagg. 34)



Parti di ricambio (vedi pagg. 35)

XXX = Trattamento

000 = cromato

250 = brushed gold-optic

340 = brushed black chrome



Pulitura (vedi il prospetto accluso)



Segno di verifica (vedi pagg. 40)

Problema	Possibile causa	Rimedio
Miscelatore duro	- Cartuccia difettosa	- Sostituire la cartuccia
Miscelatore gocciola	- Cartuccia difettosa	- Sostituire la cartuccia
Temperatura dell'acqua calda troppo bassa, niente acqua fredda, caldaia istantanea si accende quando si seleziona acqua fredda	- Limitazione dell'acqua calda regolata male - Flusso incrociato	- Regolare la limitazione dell'acqua calda - Sostituire la cartuccia



Montaggio vedi pagg. 31



Indicaciones de seguridad

- △ Durante el montaje deben utilizarse guantes para evitar heridas por aplastamiento o corte.
- △ El producto solo debe ser utilizado para fines de baño, higiene y limpieza corporal.
- △ Grandes diferencias de presión en servicio entre agua fría y agua caliente deben equilibrarse.

Indicaciones para el montaje

- Antes del montaje se debe examinarse el producto contra daños de transporte. Después de la instalación no se reconoce ningún daño de transporte o de superficie.
- Los conductos y la grifería deben montarse, lavarse y comprobarse según las normas vigentes.

Datos técnicos

Presión en servicio:	max. 1 MPa
Presión recomendada en servicio:	0,1 - 0,5 MPa
Presión de prueba:	1,6 MPa
(1 MPa = 10 bar = 147 PSI)	
Temperatura del agua caliente:	max. 70 °C
Temp. recomendada del agua caliente:	65 °C
Desinfección térmica:	max. 70 °C / 4 min

El producto ha sido concebido exclusivamente para agua potable.

Descripción de símbolos



No utilizar silicona que contiene ácido acético!



Ajuste (ver página 32)

Ajuste del límite de agua caliente. En combinación con calentadores continuos no es recomendable utilizar un bloqueo de agua caliente.



Dimensiones (ver página 33)



Diagrama de circulación (ver página 34)

Caudal con 0,3 MPa



Manejo (ver página 34)



Repuestos (ver página 35)

XXX = Acabados
000 = cromado
250 = brushed gold-optic
340 = brushed black chrome



Limpiar (ver el folleto adjunto)



Marca de verificación (ver página 40)

Problema	Causa	Solución
Manecilla va dura	- cartucho dañado	- cambiar el cartucho
Grifo pierde agua	- cartucho dañado	- cambiar el cartucho
Temperatura del agua caliente demasiado baja, agua fría calentador se dispara al abrir agua fría	- tope de agua caliente mal - Flujo cruzado	- ajustar tope - cambiar el cartucho





Veiligheidsinstructies

- ⚠ Bij de montage moeten ter voorkoming van knel- en snijwonden handschoenen worden gedragen.
- ⚠ Het product mag alleen voor het wassen, hygiënische doeleinden en voor de lichaamsreiniging worden gebruikt.
- ⚠ Grote drukverschillen tussen de koud- en warmwater-toevoer dienen vermeden te worden.

Montage-instructies

- Vóór de montage moet het product gecontroleerd worden op transportschade. Na de inbouw wordt geen transport- of oppervlakteschade meer aanvaard.
- De leidingen en armaturen moeten gemonteerd, gespoeld en gecontroleerd worden volgens de geldige normen.

Technische gegevens

Werkdruk: max.	max. 1 MPa
Aanbevolen werkdruk:	0,1 - 0,5 MPa
Getest bij:	1,6 MPa
(1 MPa = 10 bar = 147 PSI)	
Temperatuur warm water:	max. 70 °C
Aanbevolen warm water temp.:	65 °C
Thermische desinfectie:	max. 70 °C / 4 min

Het product is uitsluitend ontworpen voor drinkwater!

Symboolbeschrijving



Gebruik geen zuurhoudende silicone!



Instellen (zie blz. 32)

Instellen van de warmwaterbegrenzing. In combinatie met een doorstromer is een warmwaterblokering niet aanbevelenswaardig.



Maten (zie blz. 33)

Doorstroombiagram (zie blz. 34)

Vrije doorstroom bij 0,3 MPa:



Bediening (zie blz. 34)



Service onderdelen (zie blz. 35)

XXX = Kleuren
000 = verchromd
250 = brushed gold-optic
340 = brushed black chrome



Reinigen (zie bijgevoegde brochure)



Keurmerk (zie blz. 40)

Storing	Oorzaak	Oplossing
Bediening zwaar	- Kardoes defect of verkalkt	- Kardoes uitwisselen
Mengkraan lekt	- Kardoes defect	- Kardoes uitwisselen
Warmwater temperatuur te laag, geen koud water. Doorstroombiagram springt aan wanneer koud water gekozen is.	- Heetwaterbegrenzer verkeerd ingesteld - Kruisstroom	- Heetwaterbegrenzer instellen - Kardoes uitwisselen



Montage zie blz. 31



Sikkerhedsanvisninger

- △ Ved monteringen skal der bruges handsker for at undgå kvæstelser og snitsår.
- △ Produktet må kun bruges til bade-, hygiejne og kropsrengøringsformål.
- △ Større trykforskelle mellem koldt og varmt vand bør undgås.

Monteringsanvisninger

- Før monteringen skal produktet kontrolleres for transportskader. Efter monteringen godkendes transportskader eller skader på overfladen ikke længere.
- Ledningerne og armaturerne skal monteres, skylles og kontrolleres iht. de gældende standarder.

Tekniske data

Driftstryk:	max. 1 MPa
Anbefalet driftstryk:	0,1 - 0,5 MPa
Prøvetryk:	1,6 MPa
(1 MPa = 10 bar = 147 PSI)	
Varmtvandstemperatur:	max. 70 °C
Anbefalet varmtvandstemperatur:	65 °C
Termisk desinfektion:	max. 70 °C / 4 min

Produktet er udelukkende beregnet til drikkevand!

Symbolbeskrivelse



Der må ikke benyttes eddikesyreholdig silikone!



Forindstilling (se s. 32)

Indstilling af varmvandsbegrænsningen. I forbindelse med gennemstrømningsvandvarmere anbefaler vi ikke en varmvandsspærre.



Målene (se s. 33)



Gennemstrømningsdiagram (se s. 34)

Fri gennemstrømning ved 0,3 MPa:



Brugsanvisning (se s. 34)



Reserve dele (se s. 35)

XXX = Overflade
 000 = Krom
 250 = brushed gold-optic
 340 = brushed black chrome



Rengøring (se venligst den vedlagte brochure)



Godkendelse (se s. 40)

Fejl	Årsag	Hjælp
Grebet går trægt	- Kartusche defekt, tilkalket	- Udskift kartusche
Armaturet drypper	- Defekt kartusche	- Udskift kartusche
For lav varmtvandstemperatur. Ingen koldt vand. Vandvarmeren starter, når der åbnes for det kolde vand.	- Varmtvandsbegrænsningen er forkert indstillet - Kryds-flow	- Indstil varmtvandsbegrænsningen - Udskift kartusche





Avisos de segurança

- ⚠ Durante a montagem devem ser utilizadas luvas de protecção, de modo a evitar ferimentos resultantes de entalamentos e de cortes.
- ⚠ O produto só pode ser utilizado para fins de higiene pessoal.
- ⚠ Grandes diferenças entre as pressões das águas quente e fria devem ser compensadas.

Avisos de montagem

- Antes da montagem deve-se controlar o produto relativamente a danos de transporte. Após a montagem não são aceites quaisquer danos de transporte ou de superfície.
- As tubagens e a torneira têm que ser montadas, enxaguadas e verificadas de acordo com as normas em vigor.

Dados Técnicos

Pressão de funcionamento:	max. 1 MPa
Pressão de func. recomendada:	0,1 - 0,5 MPa
Pressão testada:	1,6 MPa
(1 MPa = 10 bar = 147 PSI)	
Temperatura da água quente:	max. 70 °C
Temp. água quente recomendada:	65 °C
Desinfecção térmica:	max. 70 °C / 4 min

Este produto foi única e exclusivamente concebido para água potável!

Descrição do símbolo



Não utilizar silicone que contenha ácido acético!



Afinação (ver página 32)

Ajuste do limitador de água quente. Em combinação com um esquentador, não é recomendável o uso de um bloqueio de água quente.



Medidas (ver página 33)



Fluxograma

(ver página 34)

Caudal a 0,3 MPa:



Funcionamento (ver página 34)



Peças de substituição

(ver página 35)

XXX = Acabamentos

000 = cromado

250 = brushed gold-optic

340 = brushed black chrome



Limpeza (consultar a seguinte brochura)



Marca de controlo



(ver página 40)

Falha	Causa	Solução
Misturadora perra	- Cartucho defeituoso, calcificado	- Substituir o cartucho
Misturadora a pingar	- Cartucho defeituoso	- Substituir o cartucho
Temperatura da água quente muito baixa, sem água fria. O esquentador dispara quando a água fria está seleccionada.	- O limitador de temperatura está incorrectamente colocado - Fluxo cruzado	- Regular o limitador de temperatura - Substituir o cartucho





Wskazówki bezpieczeństwa

-  Aby uniknąć zranień na skutek zgniecenia lub przecięcia, podczas montażu należy nosić rękawice ochronne.
-  Produkt może być używany tylko do kąpieli, higieny i czyszczenia ciała.
-  Znaczne różnice ciśnień na doptywach ciepłej i zimnej wody muszą zostać wyrównane.

Wskazówki montażowe

- Przed montażem należy skontrolować produkt pod kątem szkód transportowych. Po montażu nie widać żadnych szkód transportowych ani szkód na powierzchni.
- Przewody i armatura muszą być montowane, płukane i kontrolowane według obowiązujących norm.

Dane techniczne

Ciśnienie robocze: maks. 1 MPa
 Zalecane ciśnienie robocze: 0,1 - 0,5 MPa
 Ciśnienie próbne: 1,6 MPa
 (1 MPa = 10 bary = 147 PSI)
 Temperatura wody gorącej: maks. 70 °C
 Zalecana temperatura wody gorącej: 65 °C
 Dezynfekcja termiczna: maks. 70 °C / 4 min

Produkt przeznaczony wyłącznie do wody pitnej!

Opis symbolu



Nie stosować silikonów zawierających kwas octowy!



Ustawianie (patrz strona 32)

Ustawianie ogranicznika ciepłej wody. Używanie ogranicznika temperatury wody w połączeniu z przepływowym podgrzewaczem wody nie jest zalecane.



Wymiary (patrz strona 33)



Schemat przepływu

(patrz strona 34)

Swobodny przepływ przy 0,3 MPa:



Obsługa (patrz strona 34)



Części serwisowe

(patrz strona 35)

XXX = Kody kolorów

000 = chrom

250 = brushed gold-optic

340 = brushed black chrome



Czyszczenie (patrz dołączona broszura)



Znak jakości (patrz strona 40)

Usterka

Przyczyna

Pomoc



Uchwyt armatury pracuje z wysiłkiem	- Uszkodzony wkład, zakamieniony	- Wymiana wkładu
Armatura cieknie	- Uszkodzony wkład	- Wymiana wkładu
Za niska temperatura ciepłej wody, brak zimnej wody. Przepływowy podgrzewacz wody uruchamia się, gdy wybiera się zimną wodę.	- Niewłaściwe ustawienie ogranicznik ciepłej wody - Przepływ krzyżowy	- Ustawić ogranicznik ciepłej wody - Wymiana wkładu



Montaż patrz strona 31



Bezpečnostní pokyny

-  Pro zabránění řezným zraněním a pohmožděninám je nutné při montáži nosit rukavice.
-  Produkt smí být používán pouze ke koupání a za účelem tělesné hygieny.
-  Je nutné vyrovnat velké rozdíly tlaku mezi přípoji studené a teplé vody.

Pokyny k montáži

- Před montáží je třeba produkt zkontrolovat, zda nebyl při transportu poškozen. Po zabudování nebudou uznány žádné škody způsobené transportem nebo poškození povrchu.
- Vedení a armatura musí být namontovány, propláchnuty a otestovány podle platných norem.

Technické údaje

Provozní tlak:	max. 1 MPa
Doporučený provozní tlak:	0,1 - 0,5 MPa
Zkušební tlak:	1,6 MPa
(1 MPa = 10 bar = 147 PSI)	
Teplota horké vody:	max. 70 °C
Doporučená teplota horké vody:	65 °C
Teplná desinfekce:	max. 70 °C / 4 min

Výrobky Hansgrohe jsou vhodné pro přímý kontakt s pitnou vodou.

Popis symbolů



Nepoužívat silikon s obsahem kyseliny octové!



Nastavení (viz strana 32)

Nastavení omezovače teplé vody. Ve spojení s průtokovým ohřívačem se použití uzávěru teplé vody nedoporučuje.



Rozměry (viz strana 33)



Diagram průtoku

(viz strana 34)

Volný průtok při 0,3 MPa



Ovládání (viz strana 34)



Servisní díly (viz strana 35)

XXX = Kód povrchové úpravy

000 = chrom

250 = brushed gold-optic

340 = brushed black chrome



Čištění (viz příložená brožura)



Zkušební značka (viz strana 40)

Porucha	Příčina	Odstranění
Armatura jde ztěžka	- Kartuše je vadná, zanesená vodním kamenem	- Kartuši vyměnit
Armatura odkapává	- Kartuše je vadná	- Kartuši vyměnit
nízká teplota teplé vody .žádná studená voda průtokový ohřívač naskočí, když se navolí studená voda	- Špatně nastavená zarážka pro teplou vodu - Křížení toků	- Seřadit zarážku pro teplou vodu - Kartuši vyměnit



Montáž viz strana 31



Bezpečnostné pokyny

- △ Pri montáži musíte nosiť rukavice, aby ste predišli pomliaždeninám a rezným poraneniam.
- △ Produkt sa smie používať len na kúpanie a telesnú hygienu.
- △ Veľké rozdiely v tlaku medzi prípojkami studenej a teplej vody musia byť vyrovnané.

Pokyny pre montáž

- Pred montážou musíte produkt skontrolovať, či nebol počas transportu poškodený. Po zabudovaní nebudú uznané žiadne škody spôsobené transportom alebo poškodenia povrchu.
- Ledningarna och blandaren måste monteras, spolás igenom och kontrolleras enligt de gällande normerna.

Technické údaje

Prevádzkový tlak:	max. 1 MPa
Doporučený prevádzkový tlak:	0,1 - 0,5 MPa
Skúšobný tlak:	1,6 MPa
(1 MPa = 10 bar = 147 PSI)	
Teplota teplej vody:	max. 70 °C
Doporučená teplota teplej vody:	65 °C
Termická dezinfekcia:	max. 70 °C / 4 min

Výrobok je koncipovaný výhradne pre pitnú vodu!

Popis symbolov



Nepoužívať silikón s obsahom kyseliny octovej!



Nastavenie (viď strana 32)

Nastavenie obmedzenia teplej vody. V spojení s prietokovými ohrievačmi sa neodporúča použitie obmedzovača teplej vody.



Rozmery (viď strana 33)



Diagram prietoku

(viď strana 34)

Volný prietok pri 0,3 MPa



Obsluha (viď strana 34)



Servisné diely (viď strana 35)

XXX = Farebné označenie

000 = chróm

250 = brushed gold-optic

340 = brushed black chrome



Čistenie (nájdeť v priloženej brožúre)



Osvedčenie o skúške

(viď strana 40)

Porucha	Príčina	Pomoc
Armatúra "chodí" ťažko	- Kartuša je poškodená, vápenaté usadeniny	- Vymeniť kartušu
Z armatúry kvapká voda	- Kartuša je poškodená	- Vymeniť kartušu
Málo teplá voda, žiadna studená voda, prietokový ohrievač naskočí, keď sa navolí studená voda.	- Nesprávne nastavená zarážka na teplú vodu - Kríženie tokov	- Nastavenie zarážky na teplú vodu - Vymeniť kartušu



Montáž viď strana 31



安全技巧

- △ 装配时为避免挤压和切割受伤，必须戴上手套。
- △ 本产品只允许作为洗浴、卫生和洁身之用。
- △ 冷热水管间过大的压力差必须予以平衡。

安装提示

- 安装前必须检查产品是否受到运输损害。安装后将不认可运输损害或表面损伤。
- 管道和阀门必须根据通用标准进行安装、冲洗和检查。

技术参数

工作压力:	最大 1 MPa
推荐工作压力:	0,1 - 0,5 MPa
测试压强:	1,6 MPa
(1 MPa = 10 bar = 147 PSI)	
热水温度:	最大 70°C
推荐热水温度:	65°C
热力消毒:	最大 70°C / 4 分钟

该产品专为饮用水设计！

符号说明



请勿使用含有乙酸的硅胶！



调节(参见第页 32)

热水温度调节。如果使用即热式喷头，则不建议安装热水阀门。



大小 (参见第页 33)



流量示意图

(参见第页 34)

0,3 MPa时的流速:



操作 (参见第页 34)



备用零件 (参见第页 35)

XXX = 颜色代码

000 = 镀铬

250 = brushed gold-optic

340 = brushed black chrome



清洗 (附有小手册)



检验标记 (参见第页 40)

问题	原因	补救
龙头不灵活	- 阀芯损坏、结垢	- 更换阀芯
龙头滴水	- 阀芯损坏	- 更换阀芯
热水温度过低，没有冷水。选择冷水时，热水器启动。	- 温度限制器设置错误 - 交叉流动	- 设置温度限制器 - 更换阀芯



安装 参见第页 31



Указания по технике безопасности

- Во время монтажа следует надеть перчатки во избежание прищемления и порезов.
- Изделие разрешается использовать только в гигиенических целях: для принятия ванны и личной гигиены.
- донного клапа. Перед установкой смесителя необходимо регулировочными кранами выровнять давление холодной и горячей воды при помощи вентилей регулирующих подачу воды в квартиру.

Указания по монтажу

- Перед монтажом следует проверить изделие на предмет повреждений при перевозке. После монтажа претензии о возмещении ущерба за повреждения при перевозке или повреждения поверхностей не принимаются.
- Трубы и арматура должны быть установлены, промыты и проверены в соответствии с действующими нормами.

Технические данные

Рабочее давление: не более. 1 МПа
 Рекомендуемое рабочее давление: 0,1 - 0,5 МПа
 Давление: 1,6 МПа
 (1 МПа = 10 bar = 147 PSI)
 Температура горячей воды: не более. 70 °C
 Рекомендуемая темп. гор. воды: 65 °C
 Термическая дезинфекция: не более. 70 °C / 4 мин

Изделие предназначено исключительно для питьевой воды!

Описание символов



Не применяйте силикон, содержащий уксусную кислоту.

Подгонка (см. стр. 32)

Регулировка ограничителя горячей воды. В сочетании с проточными нагревателями не рекомендуется использовать блокировку воды.

Размеры (см. стр. 33)



Схема потока

(см. стр. 34)
Свободное истечение при 0,3 МПа:



Эксплуатация (см. стр. 34)

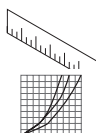

Комплект (см. стр. 35)

XXX = Цветная кодировка
 000 = хром
 250 = brushed gold-optic
 340 = brushed black chrome



Очистка (см прилагаемая брошюра)



Знак технического контроля (см. стр. 40)

Неисправность	Причина	Устранение неисправности
Арматура работает с усилием	- Картридж неисправен, засорение накипью	- Замените картридж
Арматура протекает	- Картридж неисправен	- Замените картридж
Слишком низкая температура горячей воды. Проточный нагреватель запускается при выборе холодной воды.	- Ограничение горячей воды отрегулировано неправильно	- Отрегулируйте ограничение горячей воды
	- Перекрестный поток	- Замените картридж





Biztonsági utasítások

- △ A szerelésnél a zúzódások és vágási sérülések elkerülése érdekében kesztyűt kell viselni.
- △ A terméket csak fürdéshez, mosakodáshoz, és egészségügyi tisztálkodáshoz szabad használni.
- △ A hidegvíz- és a melegvíz-csatlakozások közötti nagy nyomáskülönbséget kikell egyenlíteni!

Szerelési utasítások

- A szerelés előtt ellenőrizni kell, hogy a terméknek nincs-e szállítási sérülése. Beépítés után a szállítási- vagy felületi sérüléseket nem ismerik el.
- A vezetékeket és a csaptelepet az érvényes szabványoknak megfelelően kell felszerelni, öblíteni és ellenőrizni

Műszaki adatok

Üzemi nyomás:	max. 1 MPa
Ajánlott üzemi nyomás:	0,1 - 0,5 MPa
Nyomáspróba:	1,6 MPa
(1 MPa = 10 bar = 147 PSI)	
Forróvíz hőmérséklet:	max. 70 °C
Forróvíz javasolt hőmérséklete:	65 °C
Termikus fertőtlenítés:	max. 70 °C / 4 perc

A terméket kizárólag ivóvízhez tervezték!

Szimbólumok leírása



Ne használjon ecetsavtartalmú szilikonl!



Beállítás(lásd a oldalon 32)

A meleg víz korlátozás beállítása. Átfolyós vízmelegítőknél meleg víz korlátozó használata nem ajánlott.



Méretet (lásd a oldalon 33)



Átfolyási diagramm

(lásd a oldalon 34)

Szabad átfolyás 0,3 MPa nyomás esetén:



Használat (lásd a oldalon 34)



Tartozékok (lásd a oldalon 35)

XXX = Színkódolás

000 = króm

250 = brushed gold-optic

340 = brushed black chrome



Tisztítás (lásd a mellékelt brosúrát)



Vizsgajel (lásd a oldalon 40)

Hiba	Ok	Megoldás
Nehezen nyitható a csap.	- A kerámiabetét meghibásodott, elvízkövesedett.	- A kerámiabetétet ki kell cserélni.
Csőpög a csap.	- A kerámiabetét meghibásodott.	- A kerámiabetétet ki kell cserélni.
Túl alacsony melegvíz hőmérséklet, nincs hidegvíz. A hidegvíz kiválasztásakor beindul az átfolyós melegítő.	- A melegvíz szabályozó rosszul van beállítva. - Keresztfolyás	- A melegvíz szabályozót újra be kell állítani. - A kerámiabetétet ki kell cserélni.



Szerelés lásd a oldalon 31



Turvallisuusohjeet

- △ Asennuksessa on käytettävä käsiineitä puristumien ja viiltojen aiheuttamien tapaturmien estämiseksi.
- △ Tuotetta saa käyttää ainoastaan kylpy-, hygienia- ja puhdistustarkoituksiin.
- △ Suuret paine-erot kylmä- ja kuumavesiliitännöiden välillä on tasattava.

Asennusohjeet

- Ennen asennusta on tarkastettava tuotteen mahdolliset kuljetusvahingot. Asennuksen jälkeen kuljetus- ja pintavaurioita ei hyväksytä.
- Putket ja hana on asennettava, huuhdeltava ja tarkastettava voimassa olevien standardien mukaisesti.

Tekniset tiedot

Käyttöpaine:	maks. 1 MPa
Suosittelut käyttöpaine:	0,1 - 0,5 MPa
Koestuspaine:	1,6 MPa
(1 MPa = 10 bar = 147 PSI)	
Kuuman veden lämpötila:	maks. 70 °C
Kuuman veden suosituslämpötila:	65 °C
Lämpödesinfektio:	maks. 70 °C / 4 min

Tuote on suunniteltu käytettäväksi ainoastaan juomaveden kanssa!

Merkin kuvaus



Älä käytä etikkahappopitoista silikonial



Säätö (katso sivu 32)

Lämpötilan rajoittimen säätäminen. Emme suosittele käyttämään lämpötilan rajoitinta vedenlämmittimen (läpivirtauskuumennin) yhteydessä.



Mitat (katso sivu 33)



Virtausdiagrammi

(katso sivu 34)

Vapaa läpivirtaus 0,3 MPa paineella:



Käyttö (katso sivu 34)



Varaosat (katso sivu 35)

XXX = Värikoodaus

000 = kromi

250 = brushed gold-optic

340 = brushed black chrome



Puhdistus (katso oheinen esite)



Koestusmerkki (katso sivu 40)

Häiriö

Syy

Toimenpide

Hana on raskaskäyttöinen

- Patruuna rikki, kalkkikerrostumia

- Vaihda patruuna

Hanasta tippuu vettä

- Patruuna rikki

- Vaihda patruuna

Lämminveden lämpötila liian

- Lämminveden rajoitin väärin sää-

- Säädä lämminveden rajoitin

alhainen, ei kylmää vettä. Läpivirtaus-

-detty

kuumennin käynnistyy kylmää vettä otettaessa.

- Ristiinvirtaus

- Vaihda patruuna



Asennus katso sivu 31



! Säkerhetsanvisningar

- △ Handskar ska bäras under monteringsarbetet så att man kan undvika kläm- och skärskadorgen werden.
- △ Produkten får bara användas till kroppshygien med bad och dusch.
- △ Stora tryckskillnader mellan anslutningarna för varmt och kallt vatten måste utjämnas.

Monteringsanvisningar

- Det måste undersökas om produkten har transportskador innan den monteras. Efter monteringen accepteras inga transport- eller ytskiktsskador.
- Ledningarna och blandaren måste monteras, spolats igenom och kontrolleras enligt de gällande normerna.

Tekniska data

Driftstryck:	max. 1 MPa
Rek. driftstryck:	0,1 - 0,5 MPa
Tryck vid provtryckning: (1 MPa = 10 bar = 147 PSI)	1,6 MPa
Varmvattentemperatur:	max. 70 °C
Rek. varmvattentemp.:	65 °C
Termisk desinfektion:	max. 70 °C / 4 min

Produkten är enbart avsedd för dricksvatten!

Symbolförklaring



Använd inte silikon som innehåller ättiksyra!



Justering (se sidan 32)

Ställa in varmvattenregleringen. Tillsammans med varmvattenberedare rekommenderas inte en varmvattenspär.



Måtten (se sidan 33)



Flödesschema

(se sidan 34)

Fri genomströmning vid 0,3 MPa:



Hantering (se sidan 34)



Reservdelar (se sidan 35)

XXX = Färgkodning

000 = krom

250 = brushed gold-optic

340 = brushed black chrome



Rengöring (se den medföljande broschyren)



Testsigill (se sidan 40)

Störning	Orsak	Åtgärd
Blandare är trög	- Patron defekt, förkalkad	- Byt ut patron
Blandare droppar	- Patron defekt	- Byt ut patron
För låg varmvattentemperatur, inget kallvatten. Varmvattenberedaren slår på när kallvatten väljs.	- Varmvattenreglering felaktigt inställd - Korsflöde	- Ställ in varmvattenreglering - Byt ut patron





Saugumo technikos nurodymai

- △ Apsaugai nuo užspaudimo ir įsijovimo montavimo metu mūvėkite pirštines.
- △ Gaminys turi būti naudojamas tik maudymuisi, kūno higienai ir švarai palaikyti.
- △ Turi būti išlyginti šalto ir karšto slėgio nelygumai.

Montavimo instrukcija

- Prieš montuojant būtina patikrinti, ar gaminys nebuvo pažeistas transportavimo metu. Sumontavus pretenzijos dėl transportavimo ir paviršiaus pažeidimų nepriimamos.
- Vamzdžiai ir sujungimai turi būti montuojami, plaunami ir tikrinami pagal galiojančias normas.

Techniniai duomenys

Darbinis slėgis: ne daugiau kaip 1 MPa
 Rekomenduojamas slėgis: 0,1 - 0,5 MPa
 Bandomasis slėgis: 1,6 MPa
 (1 MPa = 10 barų = 147 PSI)

Karšto vandens temperatūra: ne daugiau kaip 70 °C
 Rekomenduojama karšto vandens temperatūra: 65 °C
 Terminis dezinfekavimas: ne daugiau kaip 70 °C / 4 min

Produktas skirtas tik geriamajam vandeniui!

Simbolio aprašymas



Nenaudokite silikono, kurio sudėtyje yra acto rūgšties!



Reguliavimas (žr. psl. 32)

Karšto vandens ribojimas. Kartu su cirkuliaciniais šildytuvais nerekomenduojama naudoti karšto vandens blokavimo įtaisų.



Išmatavimai (žr. psl. 33)



Pralaidumo diagrama

(žr. psl. 34)

Laisvas vandens pralaidumas esant 0,3 MPa slėgiui:



Eksplotacija (žr. psl. 34)



Atsarginės dalys (žr. psl. 35)

XXX = Spalvos
 000 = chrom
 250 = brushed gold-optic
 340 = brushed black chrome



Valymas (žr. pridedamoje brošiūroje)



Bandymo pažyma (žr. psl. 40)

Gedimas	Priežastis	Priemonė
Sunkiai sukiojama rankenėlė	- Kasetė pažeista, užkalkėjusi	- Pakeisti kasetę
Maišytuvus praleidžia vandenį	- Kasetė pažeista	- Pakeisti kasetę
Per mažą karšto vandens temperatūrą, nėra šalto vandens. Momentinis pašildytojas pradeda veikti, kai naudojamas šalta vanduo	- Neteisingai nustatytas karšto vandens ribotuvus - Kryžminė srovė	- Nustatyti karšto vandens ribotuvą - Pakeisti kasetę



Montavimas žr. psl. 31



Sigurnosne upute

- △ Prilikom montaže se radi sprječavanja prignječenja i posjekotina moraju nositi rukavice.
- △ Proizvod se smije primjenjivati samo za kupanje, tuširanje i osobnu higijenu.
- △ Velika razlika u pritisku između vruće i hladne vode mora biti izbalansirana.

Upute za montažu

- Prije montaže mora se provjeriti je li proizvod oštećen prilikom transporta. Nakon ugradnje se ne priznaju nikakve reklamacije koje se odnose na površinska i transportna oštećenja.
- Cijevi i armatura moraju biti postavljeni, isprani i testirani prema važećim normama.

Tehnički podaci

Najveći dopušteni tlak:	tlak 1 MPa
Preporučeni tlak:	0,1 - 0,5 MPa
Probni tlak:	1,6 MPa
(1 MPa = 10 bar = 147 PSI)	
Temperatura vruće vode:	tlak 70 °C
Preporučena temperatura vruće vode:	65 °C
Termička dezinfekcija:	tlak 70 °C / 4 min

Proizvod je koncipiran isključivo za pitku vodu!

Opis simbola



Nemojte koristiti silikon koji sadrži octenu kiselinu!



Regulacija (pogledaj stranicu 32)

Namještanje limitera tople vode. U kombinaciji s protočnim bojlerima nije preporučljiva primjena sustava za blokiranje dotoka tople vode.



Mjere (pogledaj stranicu 33)



Dijagram protoka

(pogledaj stranicu 34)

Slobodan protok na 0,3 MPa:



Upotreba (pogledaj stranicu 34)



Rezervni dijelovi (pogledaj stranicu 35)

XXX = Boje

000 = krom

250 = brushed gold-optic

340 = brushed black chrome



Čišćenje (se u priloženoj brošuri)



Oznaka testiranja (pogledaj stranicu 40)

Greška	Uzrok	Otklanjanje
Ručica se zaglavila	- Neispravan uložak - Taloženje kalcija	- Zamijenite uložak
Slavina kaplje	- Neispravan uložak	- Zamijenite uložak
Preniska temperatura vruće vode, nedostatak hladne vode. Protočni bojler se pali pri podešenoj funkciji za protok hladne vode	- Limiter vruće vode nije dobro podešen - Križni tok vode	- Podesite limiter vruće vode - Zamijenite uložak



Sastavljanje pogledaj stranicu 31



⚠ Güvenlik uyarıları

- ⚠ Montaj esnasında ezilme ve kesilme gibi yaralanmaları önlemek için eldiven kullanılmalıdır.
- ⚠ Ürün yalnızca banyo, hijyen ve beden temizliği amaçları doğrultusunda kullanılabilir.
- ⚠ Sıcak ve soğuk su bağlantıları arasında büyük basınç farklılıkları varsa, bu basınç farklılıklarının dengelenmesi gerekir.

Montaj açıklamaları

- Montaj işleminden önce ürün nakliye hasarları yönünden kontrol edilmelidir. Montaj işleminden sonra nakliye veya yüzey hasarları için sorumluluk üstlenilmemektedir.
- Boruların ve armatürün montajı, yıkanması ve kontrolü geçerli normlara göre yapılmalıdır.

Teknik bilgiler

İşletme basıncı:	azami 1 MPa
Tavsiye edilen işletme basıncı:	0,1 - 0,5 MPa
Kontrol basıncı:	1,6 MPa
(1 MPa = 10 bar = 147 PSI)	
Sıcak su sıcaklığı:	azami 70°C
Tavsiye edilen su ısısı:	65°C
Termik dezenfeksiyon:	azami 70°C / 4 dak

Ürün sadece şebeke suyu için tasarlanmıştır!

Simge açıklaması



Asetik asit içeren silikon kullanmayın!



Ayarlama (bakınız sayfa 32)

Sıcak su sınırlamasının ayarlanması. Sıcak su kilitinin sürekli ısıtıcıyla kullanılması tavsiye edilmez.



Ölçüleri (bakınız sayfa 33)



Akış diyagramı

(bakınız sayfa 34)
0,3 MPa serbest akış:



Kullanımı (bakınız sayfa 34)



Yedek Parçalar (bakınız sayfa 35)

XXX = Renkler
000 = krom
250 = brushed gold-optic
340 = brushed black chrome



Temizleme (birlikte verilen broşür)





Kontrol işareti (bakınız sayfa 40)

arıza	sebebi	yardım
Batarya kullanımı ağırlaşıyor	- Kartuş Bozulmuş ve kireçlenmiş olabilir	- Kartuşu değiştirin
Batarya su damlatıyor	- Kartuş bozuk olabilir	- Kartuşu değiştirin
Sıcak su sıcaklığı çok düşük, soğuk su yok. Soğuk su seçilince soğuk çalışmaya başlıyor.	- Isı limitleyici düzgün çalışmıyor - Çapraz akış	- Isı limitleyiciyi yeniden ayarlayın - Kartuşu değiştirin





Instrucțiuni de siguranță

-  La montare utilizați mănuși pentru evitarea contuziunilor și tăierii mâinilor.
-  Produsul poate fi utilizat doar pentru spălarea, menținerea igienei și curățarea corpului.
-  Diferențele de presiune mari între alimentarea cu apă rece și apă caldă trebuie echilibrate.

Instrucțiuni de montare

- Înainte de instalare verificați, dacă produsul prezintă deteriorări de transport. După instalare garanția nu acoperă deteriorările de transport și cele de suprafață.
- Conductele și bateriile trebuie montate, spălate și verificate conform normelor în vigoare.

Date tehnice

Presiune de funcționare:	max. 1 MPa
Presiune de funcționare recomandată:	0,1 - 0,5 MPa
Presiune de verificare:	1,6 MPa
(1 MPa = 10 bar = 147 PSI)	
Temperatura apei calde:	max. 70°C
Temperatura recomandată a apei calde:	65°C
Dezinfecție termică:	max. 70°C / 4 min

Produsul este destinat exclusiv pentru apă potabilă.

Descrierea simbolurilor



Nu utilizați silicon cu conținut de acid acetic!



Reglare (vezi pag. 32)

Reglarea limitatorului de apă caldă. Nu se recomandă folosirea unui limitator de apă caldă în combinație cu un boiler instant.



Dimensiuni (vezi pag. 33)



Diagrama de debit

(vezi pag. 34)

Debit cu curgere liberă la 0,3 MPa:



Utilizare (vezi pag. 34)



Piese de schimb (vezi pag. 35)

XXX = Coduri de culori

000 = crom

250 = brushed gold-optic

340 = brushed black chrome



Curățare (vezi broșura alăturată)



Certificat de testare

(vezi pag. 40)

Deranjament	Cauza	Măsurile de remediere
Bateria se mișcă dificil	- Cartuș defect din cauza depunerilor de calcar	- Schimbați cartușul.
Bateria picură	- Cartuș defect	- Schimbați cartușul.
Temperatura apei este prea mică, nu este apă rece. Boilerul instant pornește când se dă drumul la apa rece	- Limitarea temperaturii apei calde setată incorect. - Curgere încrucișată (apa rece în intră în conducta de apă caldă și invers)	- Setați limitarea temperaturii apei calde. - Schimbați cartușul.



Montare vezi pag. 31



⚠ Υποδείξεις ασφαλείας

- ⚠ Για να αποφύγετε τραυματισμούς κατά τη συναρμολόγηση πρέπει να φοράτε γάντια.
- ⚠ Το προϊόν επιτρέπεται να χρησιμοποιείται μόνο σαν μέσο λουτρού, υγιεινής και καθαρισμού του σώματος.
- ⚠ Οι διαφορές της πίεσης μεταξύ της σύνδεσης κρύου και ζεστού νερού θα πρέπει να αντισταθμίζονται.

Οδηγίες συναρμολόγησης

- Πριν τη συναρμολόγηση πρέπει να εξεταστεί το προϊόν για ζημιές μεταφοράς. Μετά την εγκατάσταση δεν αναγνωρίζονται ζημιές από τη μεταφορά ή επιφανειακές ζημιές.
- Οι σωλίνες και η μπαταρία πρέπει να τοποθετηθούν σύμφωνα με τα ισχύοντα πρότυπα, να τεθούν υπό πίεση και να δοκιμαστούν.

Τεχνικά Χαρακτηριστικά

Λειτουργία πίεσης:	έως 1 MPa
Συνιστώμενη λειτουργία πίεσης:	0,1 - 0,5 MPa
Πίεση ελέγχου:	1,6 MPa
(1 MPa = 10 bar = 147 PSI)	
Θερμοκρασία ζεστού νερού:	έως 70 °C
Συνιστώμενη θερμοκρασία ζεστού νερού:	65 °C
Θερμική απολύμανση:	έως 70 °C / 4 min

Το προϊόν έχει σχεδιαστεί αποκλειστικά για πόσιμο νερό!

Περιγραφή συμβόλων



Μην χρησιμοποιείτε σιλικόνη που περιέχει οξικό οξύ!



Ρύθμιση (βλ. Σελίδα 32)

Ρύθμιση του δοσομετρητή ζεστού νερού. Δεν συνιστάται η διάταξη φραγής ζεστού νερού σε συνδυασμό με ταχυθερμοσίφωνα.



Διαστάσεις (βλ. Σελίδα 33)



Διάγραμμα ροής

(βλ. Σελίδα 34)

Ελεύθερη ροή στα 0,3 MPa:



Χειρισμός (βλ. Σελίδα 34)



Ανταλλακτικά (βλ. Σελίδα 35)

XXX = Χρώματα

000 = Επιχρωμιωμένο

250 = brushed gold-optic

340 = brushed black chrome



Καθαρισμός (βλ. συνημμένο φυλλάδιο)



Σήμα ελέγχου (βλ. Σελίδα 40)

Βλάβη

Αιτία



Διόρθωση

Σκληρή μπαταρία (μείκτης)	- Ελαττωματικό φυσιγγίο, άλατα	- Αλλαγή φυσιγγίου
Η μπαταρία στάζει	- Ελαττωματικό φυσιγγίο	- Αλλαγή φυσιγγίου
Χαμηλή θερμοκρασία ζεστού νερού, καθόλου κρύο νερό. Ο ταχυθερμοσίφωνας ενεργοποιείται, όταν επιλέγεται το κρύο νερό.	- Λάθος ρύθμιση της περιοριστικής διάταξης ζεστού νερού - Σταυροειδής ροή	- Ρυθμίστε την περιοριστική διάταξη του ζεστού νερού - Αλλαγή φυσιγγίου





Varnostna opozorila

-  Pri montaži je treba nositi rokavice, da se preprečijo poškodbe zaradi zmečkanja ali urezov.
-  Ta izdelek se sme uporabljati le z namenom umivanja, vzdrževanja higiene in telesne nege.
-  Velike razlike v tlaku med priključkom za mrzlo in priključkom za toplo vodo je potrebno izravnati.

Navodila za montažo

- Pred montažo je treba izdelek preveriti glede morebitnih transportnih poškodb. Po vgradnji transportne ali površinske poškodbe ne bodo več priznane.
- Cevi in armaturo je treba montirati, izprati in preveriti po veljavnih standardih.

Tehnični podatki

Delovni tlak:	maks. 1 MPa
Priporočeni delovni tlak:	0,1 - 0,5 MPa
Preskusni tlak:	1,6 MPa
(1 MPa = 10 bar = 147 PSI)	
Temperatura tople vode:	maks. 70 °C
Priporočena temperatura tople vode:	65 °C
Termična dezinfekcija:	maks. 70 °C / 4 min

Proizvod je zasnovan izključno za sanitarno vodo!

Opis simbola



Ne smete uporabiti silikona, ki vsebuje ocetno kislino!



Justiranje (glejte stran 32)

Nastavitev omejevalnika tople vode. V povezavi s pretočnimi grelniki uporaba zapore tople vode ni priporočljiva.



Mere (glejte stran 33)



Diagram pretoka

(glejte stran 34)

Prost pretok pri 0,3 MPa:



Upravljanje (glejte stran 34)



Rezervni deli (glejte stran 35)

XXX = Barve

000 = krom

250 = brushed gold-optic

340 = brushed black chrome



Čiščenje (glejte priloženi brošuri)



Preskusni znak (glejte stran 40)

Napaka	Vzrok	Pomoč
Težko premikanje armature	- Pokvarjen vložek, poapneno	- Zamenjajte vložek
Iz armature kaplja	- Pokvarjen vložek	- Zamenjajte vložek
Prenizka temperatura tople vode, ni mrzle vode. Pretočni grelnik se sproži, kadar izberete mrzlo vodo.	- Omejevalnik tople vode ni pravilno nastavljen - Križni tok	- Nastavite omejevalnik tople vode - Zamenjajte vložek



Montaža glejte stran 31



⚠ Ohutusjuhised

- △ Kandke paigaldamisel muljumis- ja löikevigastuste vältimiseks kindaid.
- △ Toodet tohib kasutada ainult pesemis-, hügieeni- ja kehapihustamiseesmärkidel.
- △ Kui külma ja kuuma vee ühenduste surve on väga erinev, tuleb need tasakaalustada.

Paigaldamisjuhised

- Enne paigaldamist tuleb toodet kontrollida transpordikahjustuste osas. Pärast paigaldamist ei tunnustata enam transpordi- või pinnakahjustuste kaebuseid.
- Voolikute ja segisti paigaldamisel, loputamisel ja kontrollimisel tuleb lähtuda kehtivatest normatiividest.

Tehnilised andmed

Töörõhk	maks. 1 MPa
Soovitavat töörõhki:	0,1 - 0,5 MPa
Kontrollsurve:	1,6 MPa
(1 MPa = 10 baari = 147 PSI)	
Kuuma vee temperatuur:	maks. 70 °C
Soovitavat kuuma vee temperatuur:	65 °C
Termiline desinfektsioon:	maks. 70 °C / 4 min

Toode on ette nähtud eranditult joogivee jaoks!

Sümbolite kirjeldus



Ärge kasutage äädikhapet sisaldavat silikooni!



Reguleerimine (vt lk 32)

Sooja vee piirangu seadistamine. Ühenduses boileritega ei ole sooja vee blokeeringu soovitatav.



Mõõtude (vt lk 33)



Läbivooludiagramm

(vt lk 34)

Äravoolu surve 0,3 MPa



Kasutamine (vt lk 34)



Varuosad (vt lk 35)

XXX = Värvid

000 = kroom

250 = brushed gold-optic

340 = brushed black chrome



Puhastamine (vt kaasasolevast brošüürist)



Kontrollsertifikaat (vt lk 40)

Rike	Põhjus	Lahendus
Segisti käib raskelt	- Tööelement on katkine, lubjastunud	- Vahetage tööelement
Segisti tilgub	- Tööelement on katkine	- Vahetage tööelement
Liiga madal sooja vee temperatuur, külma vett pole. Läbivoolu boiler hakkab tööle, kui on valitud külm vesi.	- Kuuma vee piirang valesti seatud - Ristvool	- Seadke kuuma vee piirang - Vahetage tööelement



Paigaldamine vt lk 31



Drošības norādes

- Montāžas laikā, lai izvairītos no saspiedumiem un iegriezumiem, nepieciešams nēsāt cimdus.
- Šo produktu drīkst izmantot tikai, lai mazgātos, higiēnai un ķermeņa tīrīšanai.
- Jāizlīdzina spiediena atšķirības starp aukstā un karstā ūdens pievadiem.

Norādījumi montāžai

- Pirms montāžas nepieciešams pārbaudīt, vai produktam transportēšanas laikā nav radušies bojājumi. Pēc iebūvēšanas bojājumi, kas radušies transportēšanas laikā, vai virsmas bojājumi netiek atzīti.
- Cauruļvadi un armatūra ir jāuzstāda, jāizskalo un jāpārbauda saskaņā ar spēkā esošajiem standartiem.

Tehniskie dati

Darba spiediens:	maks. 1 MPa
Ieteicamais darba spiediens:	0,1 - 0,5 MPa
Pārbaudes spiediens:	1,6 MPa
(1 MPa = 10 bar = 147 PSI)	
Karstā ūdens temperatūra:	maks. 70°C
Ieteicamā karstā ūdens temperatūra:	65°C
Termiskā dezinfekcija :	maks. 70°C / 4 min

Izstrādājums ir paredzēts tikai dzeramajam ūdenim!

Simbolu nozīme



Neizmantojiet silikonu, kas satur etiķskābi!



Ieregulēšana (skat. lpp. 32)

Karsta ūdens ierobežotāja regulēšana. Kopā ar caurteces sildītājiem nav ieteicams izmantot ūdens bloķētāju.



Izmērus (skat. lpp. 33)



Caurplūdes diagramma

(skat. lpp. 34)

Brīva caurplūde, ja ir 0,3 MPa:



Lietošana (skat. lpp. 34)



Rezerves daļas (skat. lpp. 35)

XXX = Krāsu kodi

000 = hroma

250 = brushed gold-optic

340 = brushed black chrome



Tīrīšana (skatiet pievienotajā brošūrā)



Pārbaudes zīme (skat. lpp. 40)

Traucējums

Iemesls

Bojājumu novēršana

Jaucējkrāns smagi grozāms

- Bojāta kartuša, aizkalļojusies

- Nomainīt kartušu

Jaucējkrāns pil

- Bojāta kartuša

- Nomainīt kartušu

Pārāk zema ūdens temperatūra, nav aukstā ūdens, izvēloties auksto ūdeni, sāk darboties caurteces sildītājs

- Nepareizi noregulāta karstā ūdens bloķēšana

- Noregulēt karstā ūdens ierobežošanu

- Ūdens sajaukšanās

- Nomainīt kartušu





Sigurnosne napomene

- Prilikom montaže se radi sprečavanja prignječenja i posekotina moraju nositi rukavice.
- Proizvod sme da se koristi samo za kupanje, tuširanje i ličnu higijenu.
- Velika razlika u pritisku između vruće i hladne vode mora biti izbalansirana.

Instrukcije za montažu

- Pre montaže se mora proveriti da li je proizvod oštećen pri transportu. Nakon ugradnje se ne priznaju nikakve reklamacije koje se odnose na površinska i transportna oštećenja.
- Vodovi i armatura moraju biti postavljeni, isprani i testirani prema važećim normama.

Tehnički podaci

Radni pritisak:	maks. 1 MPa
Preporučeni radni pritisak:	0,1 - 0,5 MPa
Probni pritisak:	1,6 MPa
(1 MPa = 10 bar = 147 PSI)	
Temperatura vruće vode:	maks. 70 °C
Preporučena temperatura vruće vode:	65 °C
Termička dezinfekcija:	maks. 70 °C / 4 min

Proizvod je koncipiran isključivo za pijaću vodu!

Opis simbola



Nemojte koristiti silikon koji sadrži sirćetnu kiselinu!



Podešavanje (vidi stranu 32)

Podešavanje ograničivača tople vode. U kombinaciji sa protočnim bojlerima ne preporučuje se primena sistema za blokiranje dotoka tople vode.



Mere (vidi stranu 33)



Dijagram protoka (vidi stranu 34)

Slobodan protok na 0,3 MPa:



Rukovanje (vidi stranu 34)



Rezervni delovi (vidi stranu 35)

XXX = Oznake boja
000 = hrom
250 = brushed gold-optic
340 = brushed black chrome



Čišćenje (vidi priloženoj brošuri)



Ispitni znak (vidi stranu 40)

Smetnja	Uzrok	Pomoć
Ručica se zaglavila	- Neispravna kartuša, nataloženi kamenac	- Zamenite kartušu
Slavina kaplje	- Neispravna kartuša	- Zamenite kartušu
Preniska temperatura tople vode, nema hladne vode. Protočni bojler se pali iako je puštena hladna voda.	- Ograničavač vruće vode nije dobro podešen - Ukršteni tok vode	- Podesite ograničavač vruće vode - Zamenite kartušu



Montaža vidi stranu 31



Sikkerhetshenvisninger

- △ Bruk hansker under montasjen for å unngå klem- og kuttskader.
- △ Produktet skal kun brukes for bade-, hygiene- og kroppshygiene.
- △ Store trykkdifferanser mellom kaldt- og varmtvannstilkoblinger skal utlignes.

Montagehenvisninger

- Før montasjen skal produktet sjekkes for transportskader. Etter monteringen aksepteres ikke noen transport- eller overflateskader.
- Ledningene og armaturen skal monteres, spyles og sjekkes iht. de gyldige normer.

Tekniske data

Driftstrykk	maks. 1 MPa
Anbefalt driftstrykk:	0,1 - 0,5 MPa
Prøvetrykk	1,6 MPa
(1 MPa = 10 bar = 147 PSI)	
Varmtvannstemperatur	maks. 70 °C
Anbefalt temperatur for varmt vann	65 °C
Termisk desinfisering:	maks. 70 °C / 4 min

Produktet er utelukkende designet for drikkevann!

Symbolbeskrivelse



Ikke bruk silikon som inneholder eddiksyre!



Justering (se side 32)

Innstilling av varmtvannsbegrensning. I forbindelse med gjennomstrømningsvarmere er det ikke anbefalt å bruke en varmtvannssperre.



Mål (se side 33)



Gjennomstrømningsdiagram (se side 34)

Fri gjennomstrømning ved 0,3 MPa:



Betjening (se side 34)



Serviceledere (se side 35)

XXX = Fargekode
000 = krom
250 = brushed gold-optic
340 = brushed black chrome



Rengjøring (se vedlagt brosjyre)



Prøvemerket (se side 40)

Feil	Årsak	Feilrettelse
Armatur ikke lett bevegelig	- Kartusj defekt, forkalkning	- Kartusj byttes
Armatur drypper	- Kartusj defekt	- Kartusj byttes
For lav varmtvannstemperatur, ikke noe kaldtvann. gjennomstrømningsvarmer slår seg på når det velges kaldt vann.	- Varmtvannsbegrensning er feil innstilt - Krysstrømning	- Varmtvannsbegrensning innstilles - Kartusj byttes



Montasje se side 31



Указания за безопасност

- При монтажа трябва да се носят ръкавици, за да се избегнат наранявания поради притискане или порязване.
- Позволено е използването на продукта само за къпане, хигиена и цели на почистване на тялото.
- Големите разлики в налягането между изводите за студената и топлата вода трябва да се изравняват.

Указания за монтаж

- Преди монтажа продуктът трябва да се провери за транспортни щети. След монтажа не се признават транспортни или повърхностни щети.
- Тръбопроводите и арматурата трябва да се монтират, промият и проверят в съответствие с валидните норми.

Технически данни

Работно налягане: макс. 1 МПа
 Препоръчително работно налягане: 0,1 - 0,5 МПа
 Контролно налягане: 1,6 МПа
 (1 МПа = 10 bar = 147 PSI)
 Температура на горещата вода: макс. 70°C
 Препоръчителна температура на горещата вода: 65°C
 Термична дезинфекция: макс. 70°C / 4 мин

Продуктът е разработен само за питейна вода!

Описание на символите



Не използвайте силикон, съдържащ оцветна киселина!



Юстиране (вижте стр. 32)

Настройка на ограничителя за топлата вода. Във връзка с проточни нагреватели не се препоръчва блокировка за топлата вода



Размери (вижте стр. 33)



Диаграма на потока

(вижте стр. 34)

Свободен поток при 0,3 МПа:



Обслужване (вижте стр. 34)



Сервизни части (вижте стр. 35)

XXX = Цветово кодиране
 000 = хром
 250 = brushed gold-optic
 340 = brushed black chrome



Почистване (от приложената брошура)



Контролен знак (вижте стр. 40)

Неизправност	Причина	Помощ
Трудно подвижна арматура	- Дефектна гилза, покрита с варовик	- Сменете гилзата
Арматурата капе	- Дефектна гилза	- Сменете гилзата
Твърде ниска температура на топлата вода, няма студена вода.	- Ограничението за топлата вода е грушно настроено	- Настройте ограничението за топлата вода
Проточният нагревател се задепства, когато се избере студена вода	- Кръстосване на потока	- Сменете гилзата



Монтаж вижте стр. 31



Udhëzime sigurie

- △ Për të evituar lëndimet e pickimeve ose të prerjeve gjatë procesit të montimit duhet që të vishni doreza.
- △ Produkti duhet të përdoret vetëm qëllimet e banjave, të higjienës dhe të larjes së trupit.
- △ Ndryshimet e mëdha të presionit mes lidhjeve të ujit të ftohtë dhe atij të ngrohtë duhen ekuilibruar.

Udhëzime për montimin

- Përpara montimit duhet që produkti të kontrollohet për dëmtime nga transporti. Pas instalimit nuk do të njihet asnjë dëmtim nga transporti ose dëmtim i sipërfaqes.
- Tubacionet dhe rubinetet duhet që të montohen, të shpëlahen dhe të kontrollohen sipas standardeve në fuqi

Të dhëna teknike

Presioni gjatë punës	maks. 1 MPa
Presioni i rekomanduar:	0,1 - 0,5 MPa
Presioni për provë:	1,6 MPa
(1 MPa = 10 bar = 147 PSI)	
Temperatura e ujit të ngrohtë	maks. 70°C
Temperatura e rekomanduar e ujit të ngrohtë:	65°C
Dezinfektim Termik:	maks. 70°C / 4 min

Produkti është projektuar ekskluzivisht për ujë të pijshëm!

Përshkrimi i simbolit



Mos përdorni silikon që në përbërje ka acid acetik.



Justimi(shih faqen 32)

Rregullimi i kufizimit me ujë të nxehtë. Një kombinim me një bojler ujit nuk është i rekomanduar.



Përmasat (shih faqen 33)



Diagrami i qarkullimit

(shih faqen 34)

Rrjedhja e lirë me 0,3 Mpa:



Përdorimi (shih faqen 34)



Pjesët e servisit (shih faqen 35)

XXX = Kodimi me anë të ngjyrave

000 = krom

250 = brushed gold-optic

340 = brushed black chrome



Pastrimi (shikoni broshurën bashkëngjitur)



Shenja e kontrollit (shih faqen 40)

Dëmtim	Shkaku	Ndihme
Armatura punon rende	- Kartusha me defekt, me kalk	- Kembeni kartushen
Armatura pikon	- Kartusha me defekt	- Kembeni kartushen
Temperaturë e ulët e ujit të ngrohtë, nuk ka ujë të ftohtë. Ngrohësi elektrik i ujit ndizet kur zgjidhet uji i ftohtë.	- Kufiri i ujit të ngrohtë është regjistruar gabim	- Regjistroni kufirin e ujit të ngrohtë
	- Rrjedhje e kryqëzuar.	- Kembeni kartushen





وصف الرمز

هام! لا تستخدم السليكون الذي يحتوي على أمحاض!



الضبط (راجع صفحة 32)



ضبط تحديد المياه الدافئة. لا ينصح باستخدام محدد المياه الدافئة مع سخان المياه الوقفي.

أبعاد (راجع صفحة 33)



رسم للصرف

(راجع صفحة 34)

معدل تدفق 0,3 ميجاباسكال:



التشغيل (راجع صفحة 34)



قطع الغيار (راجع صفحة 35)



=XXX الألوان

=000 كروم

brushed gold-optic =250

brushed black chrome =340

التنظيف (راجع والكتيب المرفق)



شهادة اختبار (راجع صفحة 40)



⚠ تنبيهات الأمان

⚠ يجب إرتداء قفازات لليد أثناء التركيب لتجنب حدوث أخطار الإنحشار أو الجروح.

⚠ لا يجب استخدام المنتج إلا في أغراض الاستحمام والأغراض الصحية وأغراض تنظيف الجسم.

⚠ يجب أن يكون تيار الماء الساخن والماء البارد متعادلين في الضغط.

تعليمات التركيب

- قبل القيام بعملية التركيب، يجب فحص المنتج للتأكد من خلوه من أية تلفيات ناتجة عن النقل. بعد القيام بعملية التركيب، لن يتم الاعتراف بوجود أية تلفيات سطحية أو تلفيات ناتجة عن عملية النقل.
- يجب تركيب وغسيل واختيار التوصيلات وخلطات المياه طبقاً للمعايير السارية.

المواصفات الفنية

ضغط التشغيل: الحد الأقصى 1 ميجاباسكال

ضغط التشغيل الموصى به: 0,5 - 0,1 ميجاباسكال

ضغط الاختبار: 1,6 ميجاباسكال

(1 ميجاباسكال = 10 بار = 147 PSI)

درجة حرارة الماء الساخن: الحد الأقصى 70°C

درجة الحرارة الموصى بها للماء الساخن: 65°C

تعقيم حراري: الحد الأقصى 70°C / 4 الدقيقة

المنتج مخصص فقط لماء الشرب!

العطل	السبب	العلاج والإصلاح
الخلاط ثقيل الحركة	- الخرطوشة تالفة، تراكم عليها الجير	- قم بتغيير الخرطوشة
تساقط قطرات مياه من الخلاط	- الخرطوشة تالفة	- قم بتغيير الخرطوشة
درجة حرارة الماء الساخن منخفضة للغاية، ولا يوجد ماء بارد. سخان المياه الفوري يعمل عند استخدام الماء البارد.	- محدد الماء الساخن مضبوط بشكل خاطيء	- قم بضبط محدد الماء الساخن
	- اندفاع متعكس للمياه	- قم بتغيير الخرطوشة





13620180

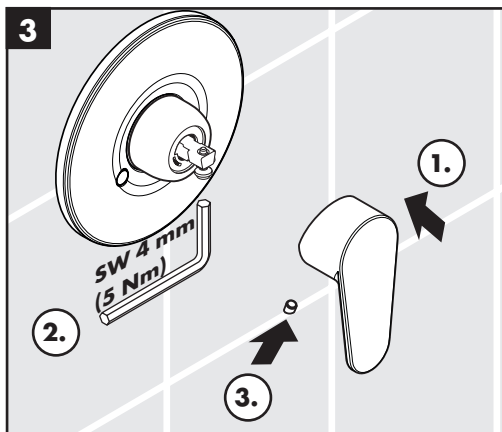
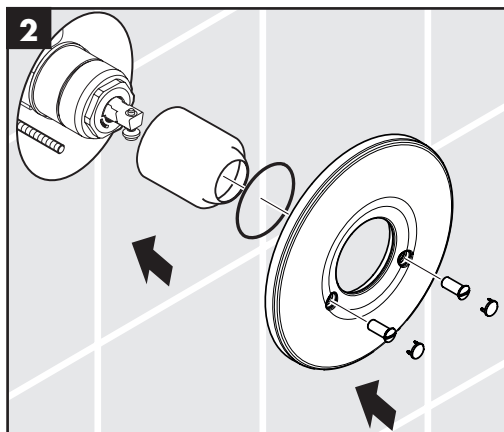
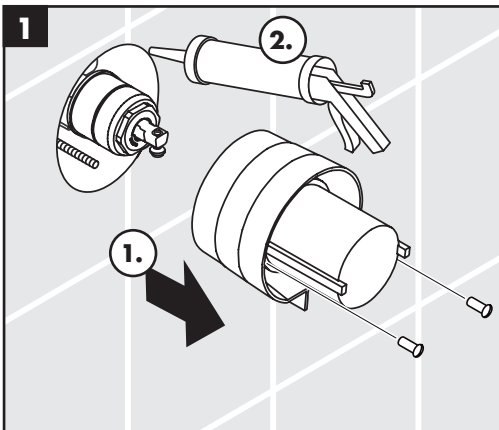
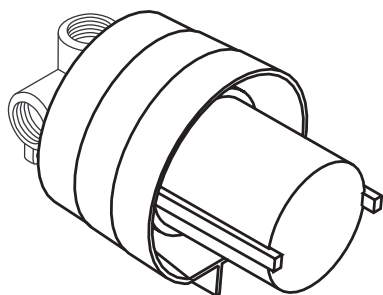

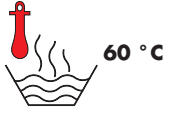

60 °C



10 °C



0,3 MPa
0,3 МПа
0,3 میجاباسکال

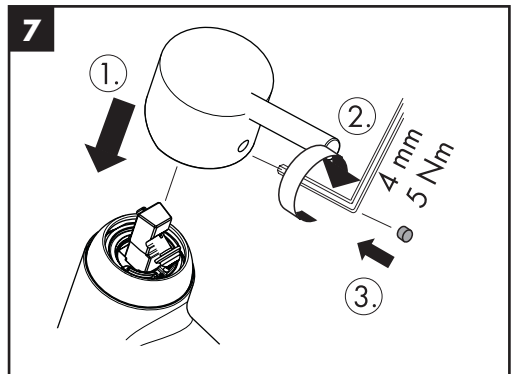
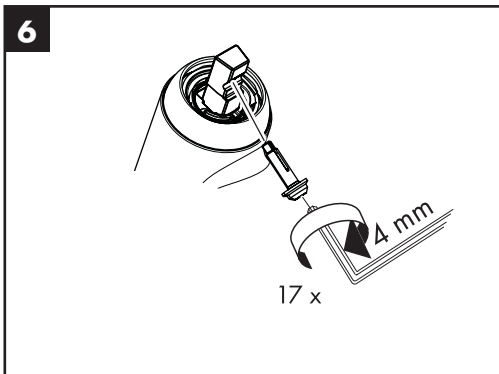
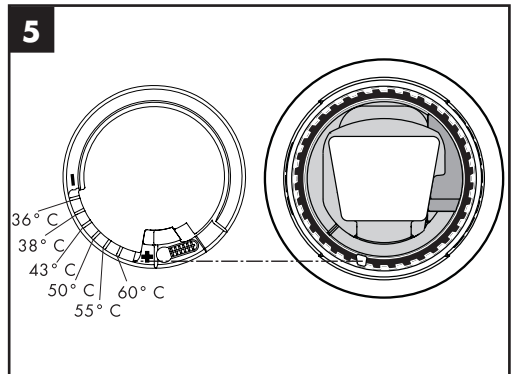
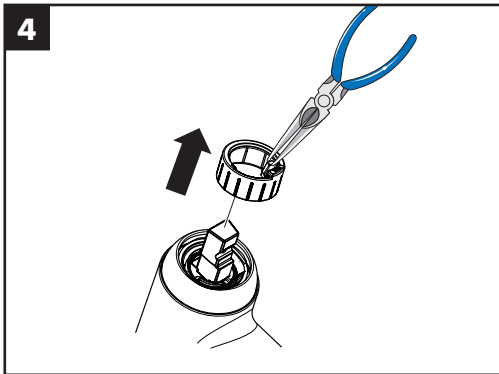
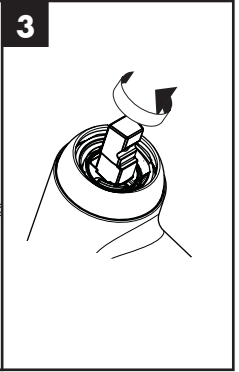
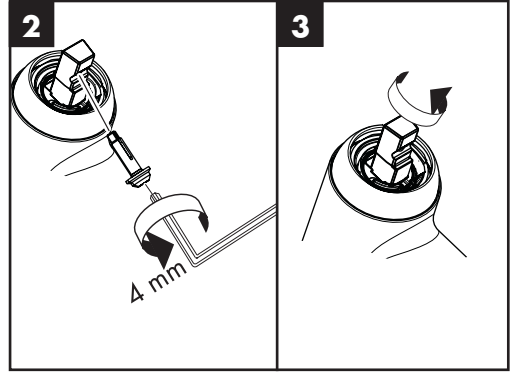
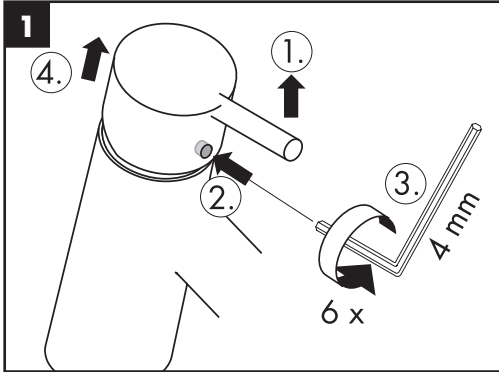

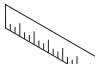

Talis E²
31636000 / 31687000

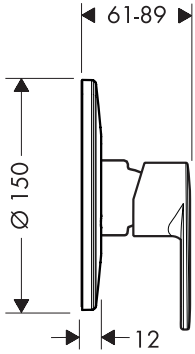

Metris
31686000

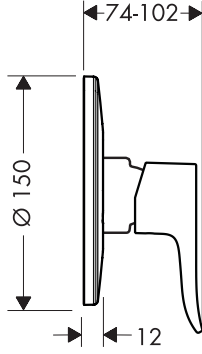

Focus E
31766000

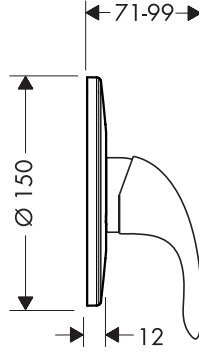

Focus
31966000

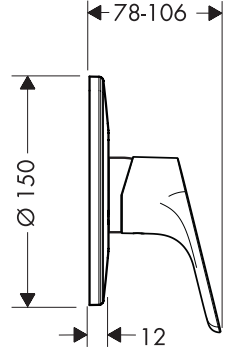

Focus E²
31967XXX / 31967007

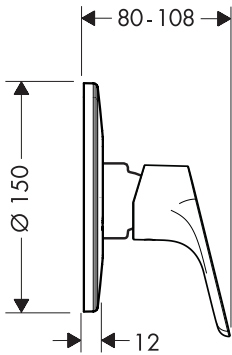

Talis S
32635000

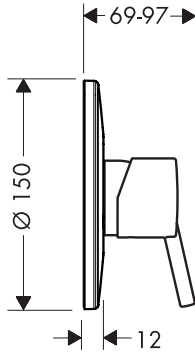

Novus
71067000 / 71068000

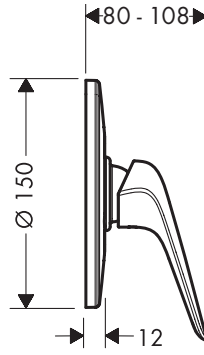

Logis
71606000 / 71666000

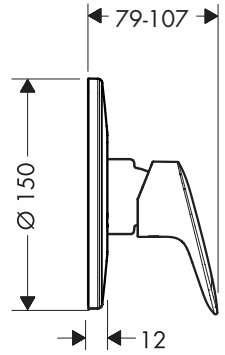

Talis E
71766000

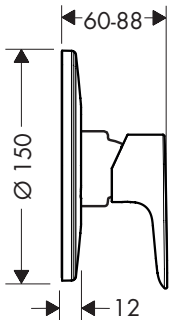

Talis S
72606000

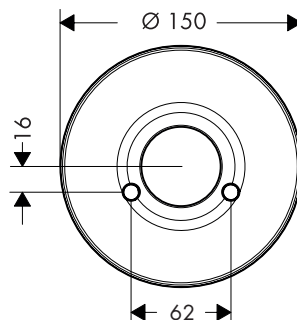
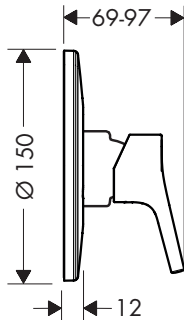

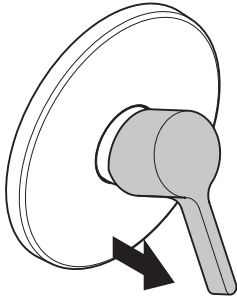
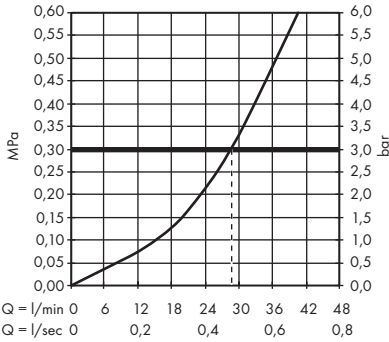

öffnen / ouvert / open / aperto / abierto / open / åbne /
 abrir / otworzyć / otevřít / otvorit / 开 / открыть / nyitás /
 avaaminen / öppna / atidaryti / Отваранье / açmak /
 deschide / ανοικτό / odpreti / avage / atvērt / otvoriti /
 árne / отваряне / hare / فتح

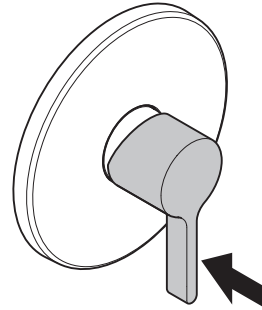

schließen / fermé / close / chiudere / cerrar / sluiten / lukke /
 fechar / zamknąć / zavřít / uzavrieť / 关 / закрыть /
 bezárás / sulkeminen / stänga / uždaryti / Zatvaranje /
 kapatmak / închide / κλειστό / zapreti / sulgege / aizvērt /
 zatvoriti / lukke / затваряне / mbylle / إغلاق

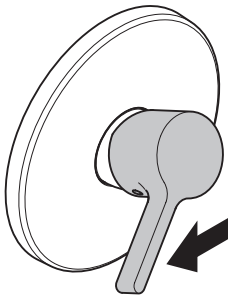

warm / chaud / hot / caldo / caliente / warm / varmt /
 quente / ciepła / teplá / teplá / 热 / горячая / meleg /
 lämmin / varmt / karštas / Vruća voda / sıcak / cald /
 ζεστό / toplo / kuum / karsts / topla / varm / тепло /
 i ngrohtë / ساخن

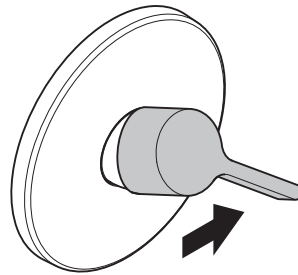

kalt / froid / cold / freddo / frío / koud / koldt / fria /
 zimna / studená / studená / 冷 / холодная / hideg /
 kylmä / kallt / šaltas / Hladno / soğuk / rece / κρύο /
 mrzlo / külm / auksts / hladno / kaldt / студено / i ftohtë /
 بارد

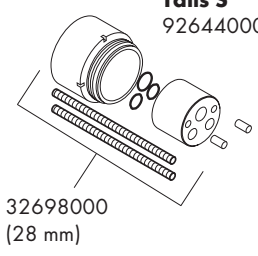
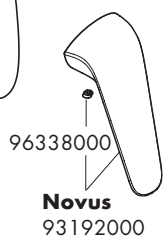
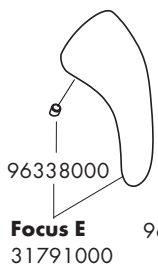
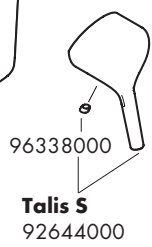
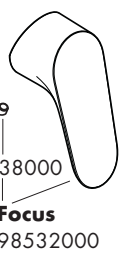
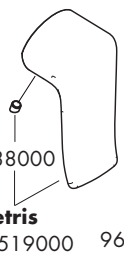
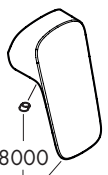
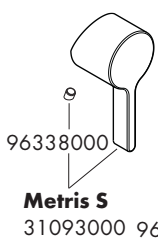
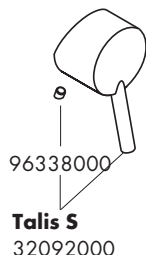
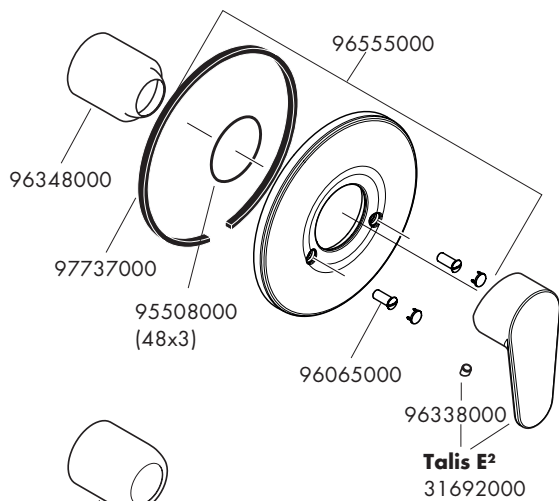







P-IX DVGW SVGW ACS WRAS ETA



31636000	PA-IX 9628/IC	X	X		
31686000	PA-IX 9628/IC		X	X	
31687000	PA-IX 9628/IC		X		
31766000	PA-IX 9628/IC		X	X	
31966000	PA-IX 9628/IC		X	X	
31967XXX	PA-IX 9628/IC		X	X	
31967007					
32635000	PA-IX 9628/IC		X	X	
71067000					
71068000					
71606000	PA-IX 9628/IC		X	X	
71666000			X		
71766000			X		
72606000					

