

DE	Gebrauchsanleitung / Montageanleitung	2
EN	Instructions for use / assembly instructions	3

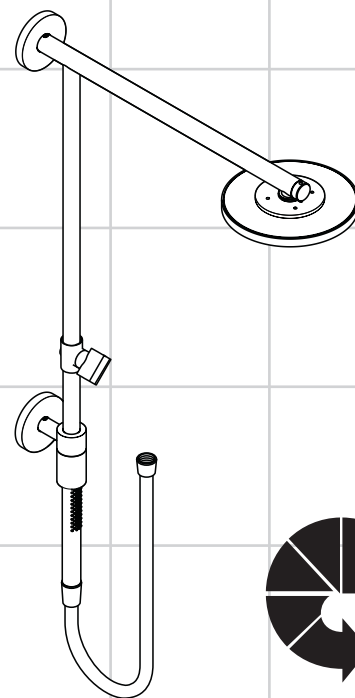

**Raindance Connect
Eco Showerpipe**
27166003



Ihr Online-Fachhändler für:

hansgrohe

- Kostenlose und individuelle Beratung
- Hochwertige Produkte
- Kostenloser und schneller Versand

- TOP Bewertungen
- Exzelerter Kundenservice
- Über 20 Jahre Erfahrung



E-Mail: info@unidomo.de | Tel.: 04621 - 30 60 89 0 | www.unidomo.de



Sicherheitshinweise

- ⚠ Bei der Montage müssen zur Vermeidung von Quetsch- und Schnittverletzungen Handschuhe getragen werden.
- ⚠ Der Kopfbrausearm ist nur für das Halten der Kopfbrause ausgelegt, er darf nicht mit weiteren Gegenständen belastet werden!
- ⚠ Kinder, sowie Erwachsene mit körperlichen, geistigen und / oder sensorischen Einschränkungen dürfen das Produkt nicht unbeaufsichtigt benutzen. Personen, die unter Alkohol- oder Drogeneinfluss stehen, dürfen das Produkt nicht benutzen.
- ⚠ Der Kontakt der Brausestrahlen mit empfindlichen Körperstellen (z. B. Augen) muss vermieden werden. Es muss ein ausreichender Abstand zwischen Brause und Körper eingehalten werden.
- ⚠ Das Produkt darf nicht als Haltegriff benutzt werden. Es muss ein separater Haltegriff montiert werden.
- ⚠ Das Produkt darf nur zu Bade-, Hygiene- und Körperreinigungszwecken eingesetzt werden.
- ⚠ Große Druckunterschiede zwischen den Kalt- und Warmwasseranschlüssen müssen ausgeglichen werden.

Montagehinweise

- Vor der Montage muss das Produkt auf Transportschäden untersucht werden. Nach dem Einbau werden keine Transport- oder Oberflächenschäden anerkannt.
- Die Leitungen und die Armatur müssen nach den gültigen Normen montiert, gespült und geprüft werden.
- Die in den Ländern jeweils gültigen Installationsrichtlinien sind einzuhalten.
- Die in der Montageanleitung angegebenen Montagemaße sind ideal für Personen von ca. 1800 mm Körpergröße und müssen gegebenenfalls angepasst werden. Hierbei ist darauf zu achten, dass sich bei geänderter Montagehöhe die Mindesthöhe ändert und die Änderung der Anschlussmaße berücksichtigt werden müssen.
- Bei der Montage des Produktes durch qualifiziertes Fachpersonal ist darauf zu achten, dass die Befestigungsfläche im gesamten Bereich der Befestigung plan ist (keine vorstehenden Fugen oder Fliesenversatz), der Wandaufbau für eine Montage des Produktes geeignet ist und keine Schwachstellen aufweist. Die beigelegten Schrauben und Dübel sind nur für Beton geeignet. Bei anderen Wandaufbauten sind die Herstellerangaben des Dübelherstellers zu beachten.
- Die der Brause beigelegte Siebdichtung muss eingebaut werden, um Schmutzeinspülungen aus dem Leitungsnetz zu vermeiden. Schmutzeinspülungen können die Funktion beeinträchtigen und/oder zu Beschädigungen an Funktionsteilen der Brause führen, für hieraus ergebende Schäden haftet Hansgrohe nicht.
- Die Brause darf nur nach einem Absperrventil oder einer Sanitärarmatur angeschlossen werden.
- Im Notfall kann das Rohr zwischen Armatur und Kopfbrause im unteren Bereich mit einer feinen Säge gekürzt werden.

Technische Daten

Betriebsdruck:	max. 0,6 MPa
Empfohlener Betriebsdruck: (1 MPa = 10 bar = 147 PSI)	0,19 - 0,4 MPa
Heißwassertemperatur:	max. 60°C
Thermische Desinfektion:	max. 70°C / 4 min

Eigensicher gegen Rückfließen

Das Produkt ist ausschließlich für Trinkwasser konzipiert!

Symbolbeschreibung



Kein essigsäurehaltiges Silikon verwenden!



Serviceteile (siehe Seite 3)

Sonderzubehör (nicht im Lieferumfang enthalten)



Fliesenausgleichsscheibe chrom #98681000



Maße (siehe Seite 8)



Durchflussdiagramm (siehe Seite 8)

- ① Kopfbrause
- ② Handbrause



Reinigung (siehe Seite 9) und beiliegende Broschüre



Bedienung (siehe Seite 11)









Montage siehe Seite 4



Eckmontageset siehe Seite 6



Safety Notes

-  Gloves should be worn during installation to prevent crushing and cutting injuries.
-  The arm of the shower head is intended only to hold the shower head. Do not load it down with other objects!
-  Children as well as adults with physical, mental and/or sensoric impairments must not use this product without proper supervision. Persons under the influence of alcohol or drugs are prohibited from using this product.
-  Do not allow the streams of the shower touch sensitive body parts (such as your eyes). An adequate distance must be kept between the shower and you.
-  The product may not be used as a holding handle. A separate handle must be installed.
-  The shower system may only be used for bathing, hygienic and body cleaning purposes.
-  The hot and cold supplies must be of equal pressures.

Installation Instructions

- Prior to installation, inspect the product for transport damages. After it has been installed, no transport or surface damage will be honoured.
- The pipes and the fixture must be installed, flushed and tested as per the applicable standards.
- The plumbing codes applicable in the respective countries must be observed.
- The installation dimensions stated in these installation instructions are ideal for people of approximately 1800 mm in body height. The dimensions can be altered if required. In this case, pay attention to the fact that a change of installation height will also change the minimum height, and that the altered mounting dimensions must be taken into consideration.
- Where the contractor mounts the product, he should ensure that the entire area of the wall to which the mounting plate is to be fitted, is flat (no projecting joints or tiles sticking out), that the structure of the wall is suitable for the installation of the product and has no weak points. The enclosed screws and dowels are only suitable for concrete. For another wall constructions the manufacturer's indications of the dowel manufacturer have to be taken into account.
- The mesh washer must be insert to protect the overhead shower against incoming dirt by pipework. Incoming dirt leads to defects or/and can damage parts of the shower; such caused faults voids all liability and guarantee claims.
- The shower may only be connected downstream of a shut-off valve or sanitary fitting.
- If required, the bottom part of the pipe between the fixture and the shower head can be shortened with a fine-toothed saw.

Technical Data

Operating pressure: max. 0,6 MPa
 Recommended operating pressure: 0,19 - 0,4 MPa
 (1 MPa = 10 bar = 147 PSI)
 Hot water temperature: max. 60°C
 Thermal disinfection: max. 70°C / 4 min

Safety against backflow

The product is exclusively designed for drinking water!

Symbol description

 Do not use silicone containing acetic acid!

 **Spare parts** (see page 3)

 **Special accessories** (order as an extra)

 tile-matching-disk chrome plated #98681000

 **Dimensions** (see page 8)

 **Flow diagram** (see page 8)

- ① overhead shower
- ② Hand shower

 **Cleaning** (see page 9) and enclosed brochure

 **Operation** (see page 11)



Assembly see page 4

corner fitting set see page 6

