



**UNIDOMO®**

**Web:** [www.unidomo.de](http://www.unidomo.de)

**Telefon:** 04621- 30 60 89 0

**Mail:** [info@unidomo.com](mailto:info@unidomo.com)

**Öffnungszeiten:** Mo.-Fr. 8:00-17:00 Uhr

**VIESMANN**

**Buderus**

 **Vaillant**

**WOLF**

 **JUNKERS**  **BOSCH**

 **remeha**

 **DAIKIN**

**ROTEX**

a member of DAIKIN group



-  Individuelle Beratung
-  Kostenloser Versand
-  Hochwertige Produkte

-  Komplettpakete
-  Über 15 Jahre Erfahrung
-  Markenhersteller

- DE** Gebrauchsanleitung / Montageanleitung  
**FR** Mode d'emploi / Instructions de montage  
**EN** Instructions for use / assembly instructions  
**IT** Istruzioni per l'uso / Istruzioni per Installazione  
**ES** Modo de empleo / Instrucciones de montaje  
**NL** Gebruiksaanwijzing / Handleiding  
**DK** Brugsanvisning / Monteringsvejledning  
**PT** Instruções para uso / Manual de Instalação  
**PL** Instrukcja obsługi / Instrukcja montażu  
**CS** Návod k použití / Montážní návod  
**SK** Návod na použitie / Montážny návod  
**ZH** 用户手册 / 组装说明  
**RU** Руководство пользователя /  
Инструкция по монтажу  
**FI** Käyttöohje / Asennusohje  
**SV** Bruksanvisning / Monteringsanvisning  
**LT** Vartotojo instrukcija / Montavimo instrukcijos  
**HR** Upute za uporabu / Uputstva za instalaciju  
**TR** Kullanım kılavuzu / Montaj kılavuzu  
**RO** Manual de utilizare / Instrucțiuni de montare  
**EL** Οδηγίες χρήσης / Οδηγία συναρμολόγησης  
**SL** Navodilo za uporabo / Navodila za montažo  
**ET** Kasutusjuhend / Paigaldusjuhend  
**LV** Lietošanas pamācība / Montāžas instrukcija  
**SR** Uputstvo za upotrebu / Uputstvo za montažu  
**NO** Bruksanvisning / Montasjeveiledning  
**BG** Инструкция за употреба /  
Ръководство за монтаж  
**SQ** Udhëzuesi i përdorimit / Udhëzime rreth montimit  
**AR** دليل الاستخدام / تعليمات التجميع  
**HU** Használati útmutató / Szerelési útmutató

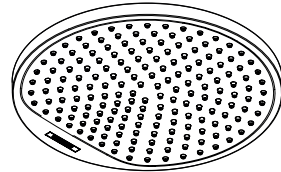

**Crometta S 240 1jet**  
26723000

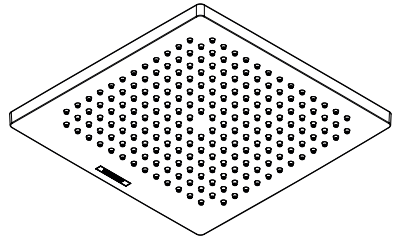

**Crometta E 240 1jet**  
26726000



### Crometta S 240 1jet 26723000

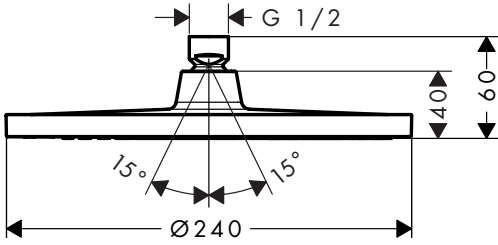

### Crometta E 240 1jet 26726000

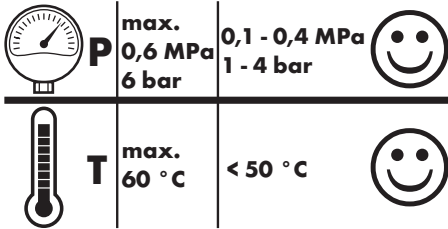
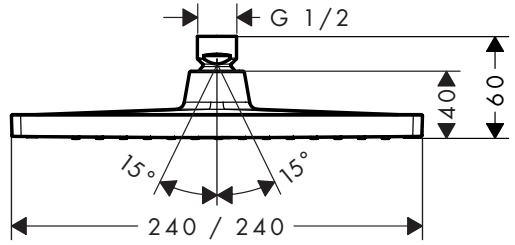

### Crometta S 240 1jet 26723000

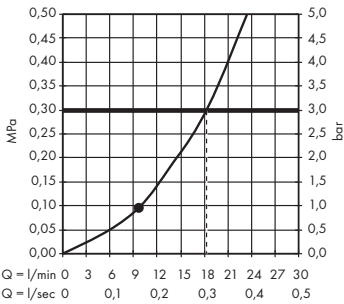

### Crometta E 240 1jet 26726000

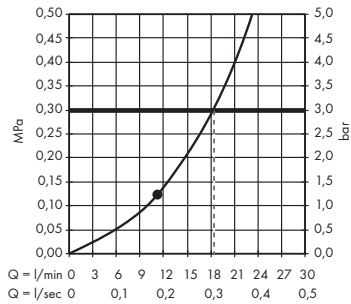

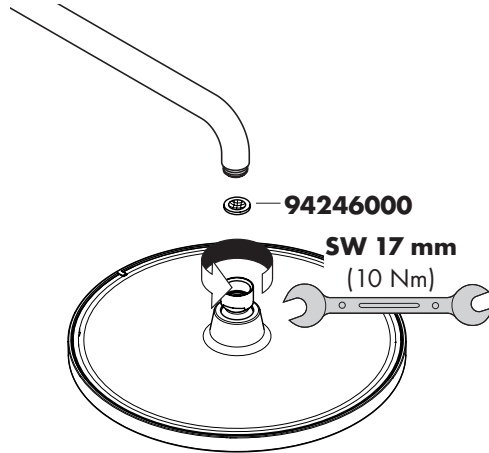

	P-IX	DVGW	SINTEF	NF	STF	CERTIFICATION BODY KIWA
26723000	P-IX 28843/IIB			X		
26726000	P-IX 28844/IIB			X		

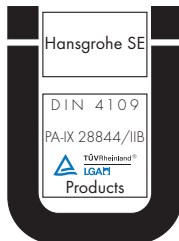



- DE** Reinigungsempfehlung / Garantie / Kontakt
- FR** Recommandation pour le nettoyage / Garanties / Contact
- EN** Cleaning recommendation / Warranty / Contact
- IT** Raccomandazione di pulizia / Garanzia / Contatto
- ES** Recomendaciones para la limpieza / Garantía / Contacto
- NL** Aanbevelingen inzake reiniging / Garantie / Contact
- DK** Rensning, anbefaling / Garanti / Kontakt
- PT** Recomendações de limpeza / Garantia / Contacto
- PL** Zalecenie dotyczące pielęgnacji / Gwarancja / Kontakt
- CS** Doporučení k čištění / Záruka / Kontakt
- SK** Odporúčania pre čistenie / Záruka / Kontakt
- ZH** 清洁指南 / 担保 / 接触
- RU** Рекомендации по очистке / Гарантия / Контакты
- HU** Tisztítási tanácsok / Garancia / érintkezés
- FI** Puhdistussuositus / Takuu / Kosketus
- SV** Rengöringsrekommendationer / Garanti / Contacto
- LT** Valymo rekomendacijos / Garantija / Kontaktai
- HR** Preporuke za čišćenje / Garancija / Kontakt
- TR** Temizleme önerisi / Garanti / Temas
- RO** Recomandări pentru curățare / Garanție / Contact
- EL** Σύσταση καθαρισμού / Εγγύηση / επαφή
- SL** Priporočilo za čiščenje / Garancija / Kontakt
- ET** Puhastussuovitused / Garantii / Kontakt
- LV** Tīrīšanas ieteikumi / Garantija / Kontakti
- SR** Preporuke za čišćenje / Garancija / Kontakt
- NO** Anbefaling for rengjøring / Garanti / Kontakt
- BG** Препоръка за почистване / Гаранция / Контакт
- SQ** Këshilla rreth pastrimit / Garancia / Kontakt
- KO** 세정시 권장사항 / 품질보증 / 접촉
- AR** توصيات التنظيف / الضمان (الولايات المتحدة الأمريكية) / اتصال



[www.hansgrohe.com/  
cleaning-recommendation](http://www.hansgrohe.com/cleaning-recommendation)

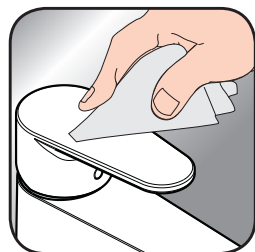

[www.hansgrohe.com/  
cleaning-recommendation](http://www.hansgrohe.com/cleaning-recommendation)



[www.hansgrohe.com/  
cleaning-recommendation](http://www.hansgrohe.com/cleaning-recommendation)



[www.hansgrohe.com/  
cleaning-recommendation](http://www.hansgrohe.com/cleaning-recommendation)

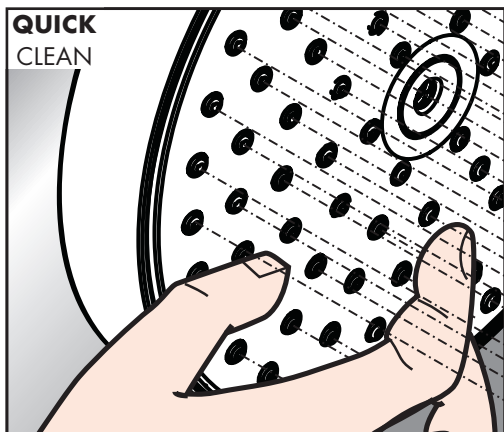

**DE** Einfach sauber: Kalk lässt sich von den Noppen ganz leicht abrubbeln.

**FR** La propreté en toute simplicité: les dépôts formés sur les buses élastiques en silicone s'éliminent par un simple passage de la main.

**EN** Just clean: simply rub over the spray nozzles to remove lime scale.

**IT** Facile da pulire: Il calcare viene eliminato semplicemente dagli ugelli elastici in silicone.

**ES** Fácil asear: La cal se puede retirar sencillamente frotando con los dedos de las toberas elásticas de silicona.

**NL** Eenvoudig schoon: Kalk kan eenvoudig van de poppen worden gewreven.

**DK** Enkel rengøring: Det er let at fjerne kalkaflejringer fra stråledyserne.

**PT** Simplesmente limpo: o calcário pode ser simplesmente retirado das saliências através de fricção.

**PL** Po prostu czysto: Pęczki można całkiem łatwo oczyścić z kamienia.

**CS** Jednoduše čistě: Vapenné usazeniny můžete z popků snadno odstranit oříením.

**SK** Jednoducho čistý: Vodný kameň sa dá zo štetín celkom ľahko odstrániť.

**ZH** 清洁: 只需要揉搓花洒表面的出水孔即可去除水垢。

**RU** Простота чистки: известь очень легко стирается с утолщений.

**HU** Egyszerűen tisztá: a vízkő egészen könnyen ledörzsölhető a csomókról.

**FI** Yksinkertaisesti puhdas: kalkin voi helposti hieroa irti nyypiästä.

**SV** Enkelt att göra rent: det är lätt att ta bort kalk från popporna.

**LT** Paprasta švara: kalkės lengvai nugrandomos nuo kilpos.

**HR** Jednostavno čisto: Kamenac se sasvim lako uklanja s izbočina.

**TR** Sadece temiz: Kireç, düğümlerle kolayca ovalanabilir.

**RO** Pur și simplu curat: Calcarul se îndepărtează ușor de pe noduri prin frecare.

**EL** Απλά τέλεια καθαριότητα: Τα άλατα μπορούν να αφαιρεθούν με μεγάλη ευκολία από τα στόμια.

**SL** Preprosto čisto: arpenec se z lahkoto podrgne z vozličkov.

**ET** Lihtsalt puhas: luoja saab nuppudel lihtsalt maha hõõruda.

**LV** Vienkārša tīrīšana: kaļķis no izvirzījumiem ir viegli norubināms.

**SR** Jednostavno čisto: Kamenac se sasvim lako skida sa izbočina.

**NO** Simpelten ren: Ved å gnikke er det lett å fjerne kalk fra nuppene.

**BG** Просто чисто: Варовикът лесно може да се изтърси от удебеленията.

**SQ** Thjesht dhe pastër. Mbetjet gëlqerore mund të hiqen me fërkim të lehtë.

**AR** إنه سهل التنظيف، حيث يسقط الجير بسهولة شديدة من الأجزاء الناتئة

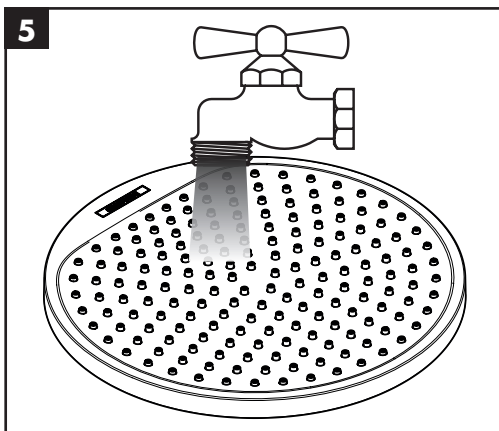
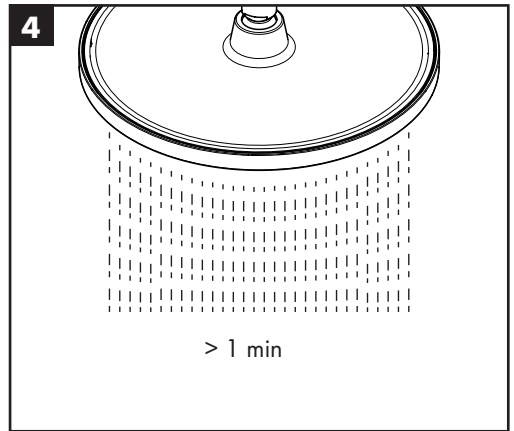
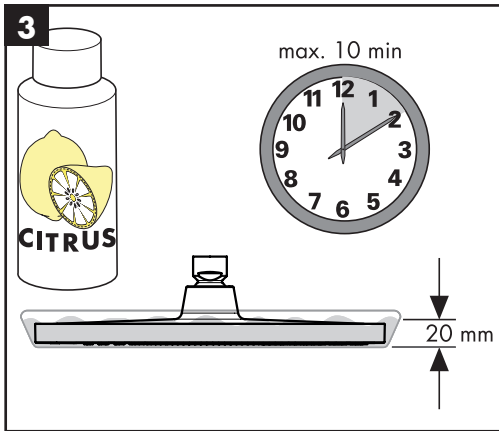
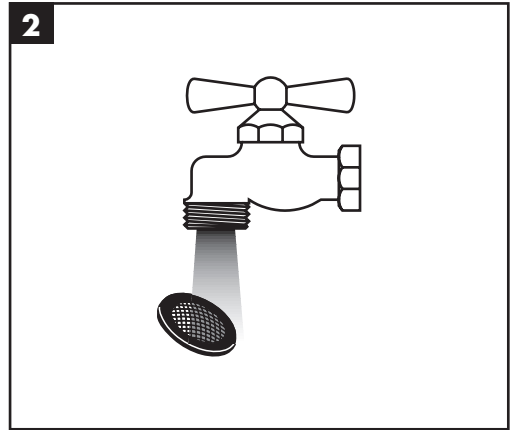
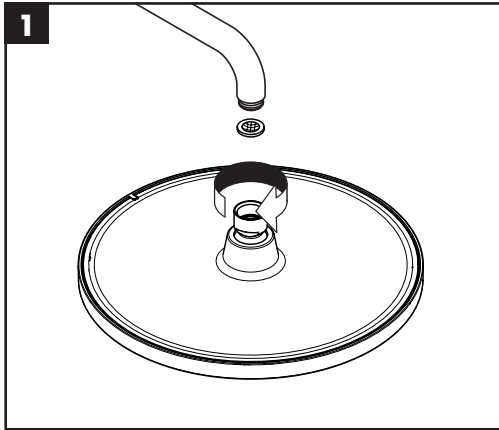





---

**hansgrohe**

Hansgrohe · Auestraße 5 · 9 · D-77761 Schiltach · Telefon +49 (0) 78 36/51-1282 · Telefax +49 (0) 7836/511440  
E-Mail: [info@hansgrohe.com](mailto:info@hansgrohe.com) · Internet: [www.hansgrohe.com](http://www.hansgrohe.com)

10/2019  
9.0130001