

<b>EN</b> Instructions for use / assembly instructions	<b>2</b>
<b>DE</b> Gebrauchsanleitung / Montageanleitung	<b>2</b>



**Raindance E Eco**  
26540403



**Marin² Multi**  
28379003

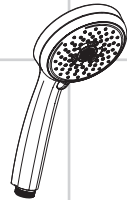

**Croma 100 Multi**  
28536003

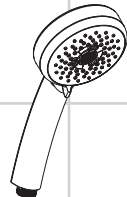

**Verso Multi**  
28778003



**Ihr Online-Fachhändler für:**

**hansgrohe**

- Kostenlose und individuelle Beratung
- Hochwertige Produkte
- Kostenloser und schneller Versand



- TOP Bewertungen
- Exzelerter Kundenservice
- Über 20 Jahre Erfahrung



**E-Mail: [info@unidomo.de](mailto:info@unidomo.de) | Tel.: 04621 - 30 60 89 0 | [www.unidomo.de](http://www.unidomo.de)**



## Safety Notes

-  Gloves should be worn during installation to prevent crushing and cutting injuries.
-  Do not allow the streams of the shower touch sensitive body parts (such as your eyes). An adequate distance must be kept between the shower and you.
-  The shower may only be used for bathing, hygiene and body cleansing purposes.

## Installation Instructions

- The mesh washer must be insert to protect the overhead shower against incoming dirt by pipework. Incoming dirt leads to defects or/and can damage parts of the shower; such caused faults voids all liability and guarantee claims.

## Technical Data

Operating pressure:	max. 0,6 MPa
Recommended operating pressure: (1 MPa = 10 bar = 147 PSI)	0,1 - 0,4 MPa
Hot water temperature:	max. 60 °C

## Symbol description



**Dimensions** (see page 3)



**Flow diagram**  
(see page 3)



**Operation** (see page 5)





**Cleaning** (see page 5) enclosed brochure



**Spare parts** (see page 7)

## Sicherheitshinweise

-  Bei der Montage müssen zur Vermeidung von Quetsch- und Schnittverletzungen Handschuhe getragen werden.
-  Der Kontakt der Brausestrahlen mit empfindlichen Körperstellen (z. B. Augen) muss vermieden werden. Es muss ein ausreichender Abstand zwischen Brause und Körper eingehalten werden.
-  Die Brause darf nur zur Bade-, Hygiene- und Körperreinigungszwecke eingesetzt werden.

## Montagehinweise

- Die der Brause beige packte Siebdichtung muss eingebaut werden, um Schmutzeinspülungen aus dem Leitungsnetz zu vermeiden. Schmutzeinspülungen können die Funktion beeinträchtigen und/oder zu Beschädigungen an Funktionsteilen der Brause führen, für hieraus ergebende Schäden haftet Hansgrohe nicht.

## Technische Daten

Betriebsdruck:	max. 0,6 MPa
Empfohlener Betriebsdruck: (1 MPa = 10 bar = 147 PSI)	0,1 - 0,4 MPa
Heißwassertemperatur:	max. 60 °C

## Symbolerklärung



**Maße** (siehe Seite 3)



**Durchflussdiagramm**  
(siehe Seite 3)



**Bedienung** (siehe Seite 5)



**Reinigung** (siehe Seite 6) und beiliegende Broschüre



**Serviceteile** (siehe Seite 7)

**Assembly see page 5**



**Montage siehe Seite 5**

## Raindance E Eco

26540403

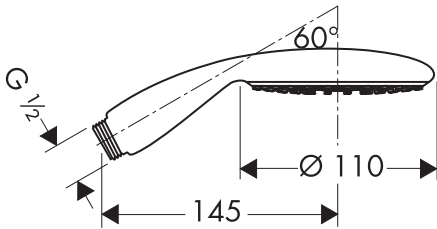
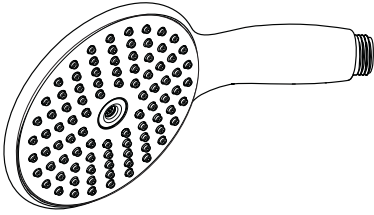

## Marin<sup>2</sup> Multi

28379003

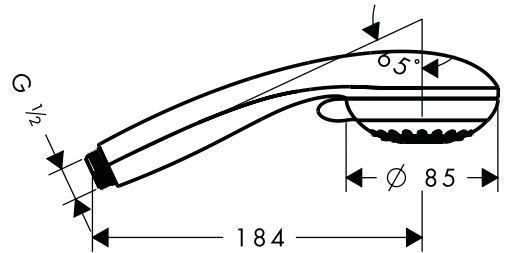
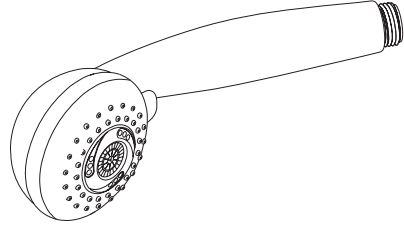

## Raindance E Eco

26540403

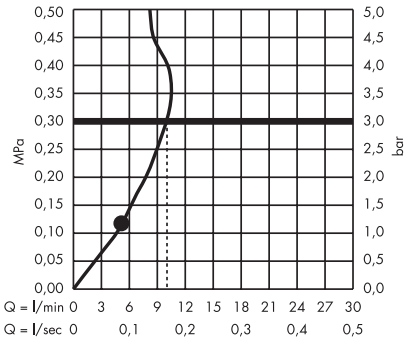

## Marin<sup>2</sup> Multi

28379003

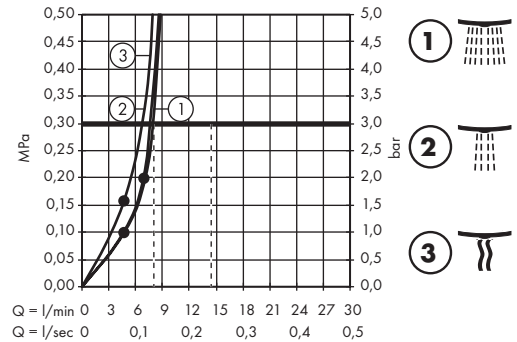



**Croma 100 Multi**  
28536003

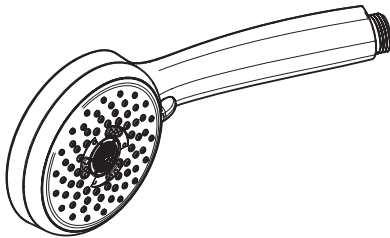

**Verso Multi**  
28778003

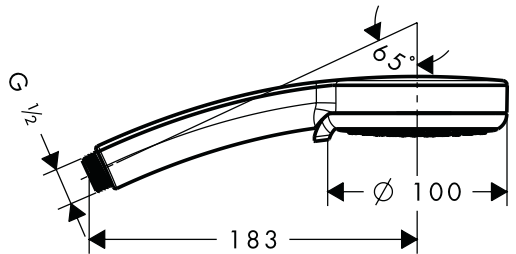
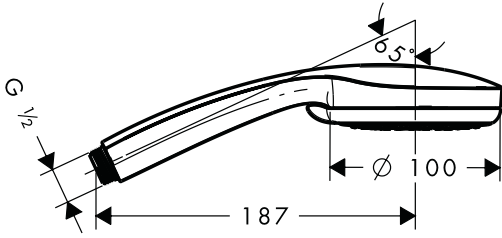
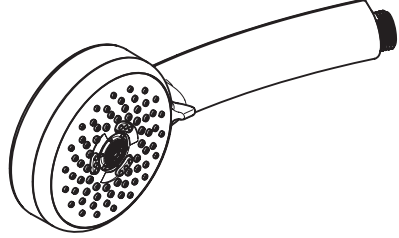

**Croma 100 Multi**  
28536003

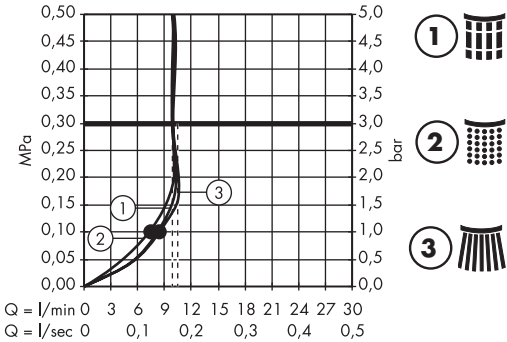

**Verso Multi**  
28778003

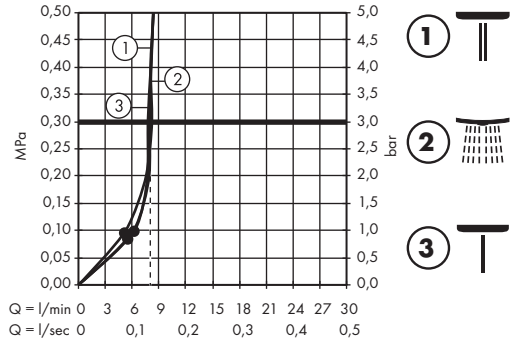

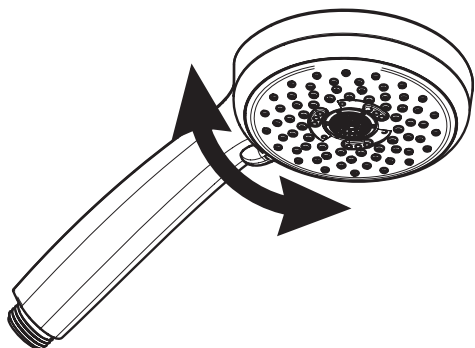
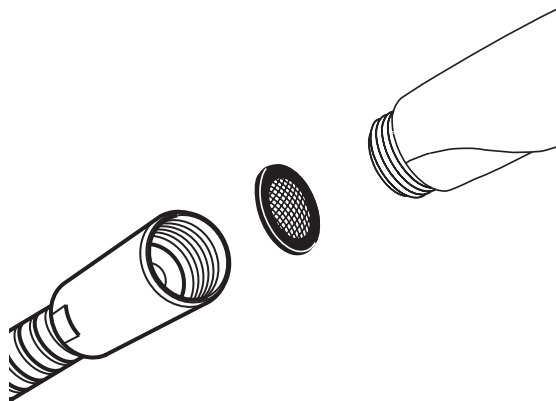

### Marin<sup>2</sup> Multi

28379003



### Croma Multi

28536003



### Verso Multi

28778003



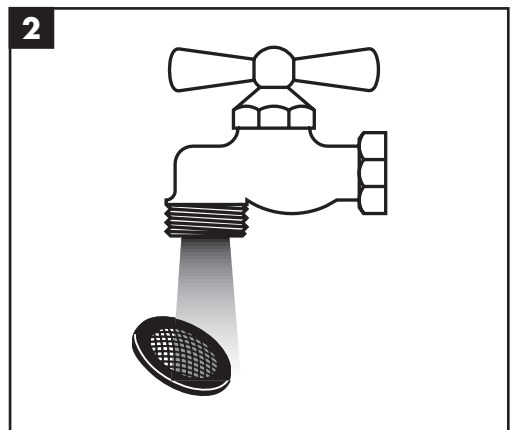
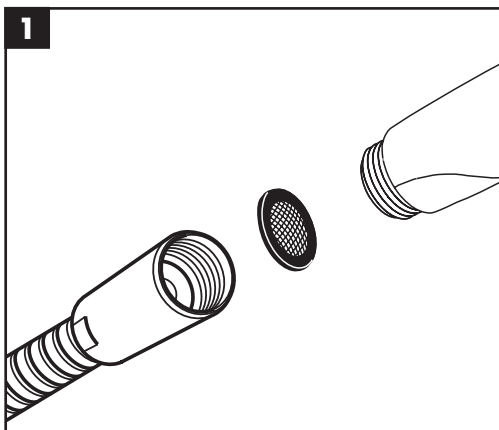
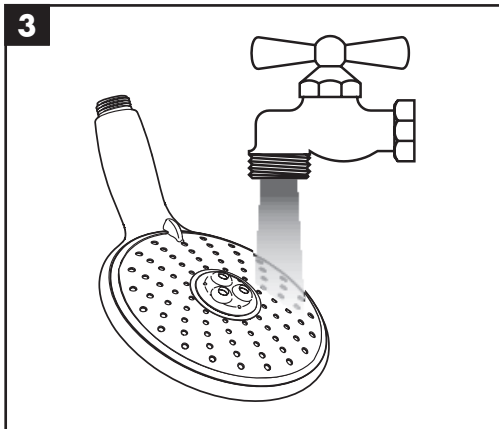
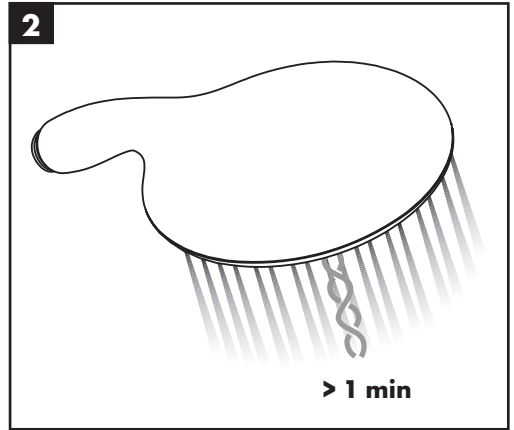
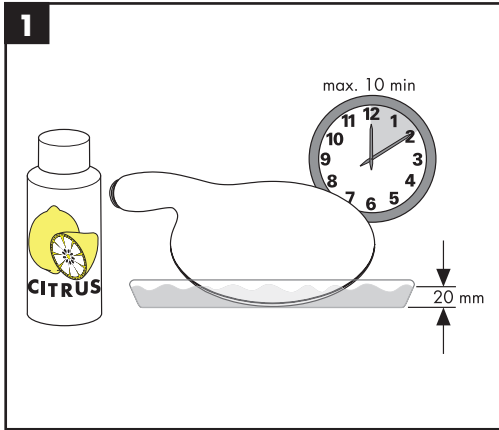



**Raindance E Eco**

26540403

94246000



98894000

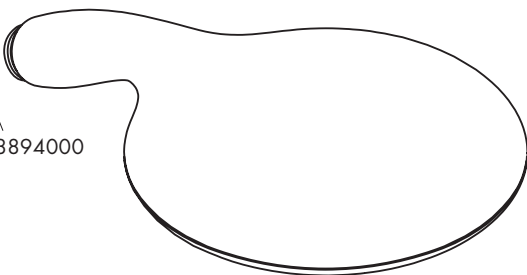

**Marin<sup>2</sup> Multi**

28379003

94246000



95659000

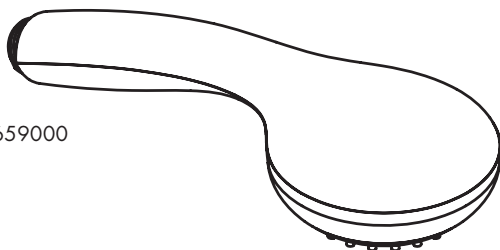

**Croma Multi**

28536003

94246000



98894000

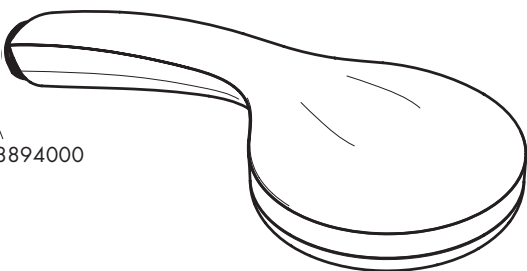

**Verso Multi**

28778003

94246000



95659000

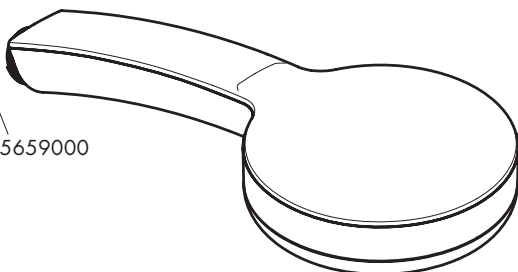



---

**hansgrohe**

Hansgrohe · AuestraÙe 5 · 9 · D-77761 Schiltach · Telefon +49 (0) 78 36/51-1282 · Telefax +49 (0) 7836/511440  
E-Mail: [info@hansgrohe.com](mailto:info@hansgrohe.com) · Internet: [www.hansgrohe.com](http://www.hansgrohe.com)

04/2015  
9.04681.07