

DE Gebrauchsanleitung / Montageanleitung

EN Instructions for use / assembly instructions

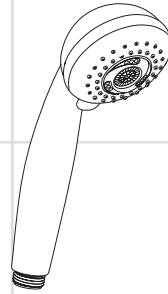

Crometta 85
Multi
28563003

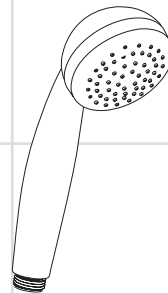

Crometta 85
Green
28561003



Ihr Online-Fachhändler für:

hansgrohe

- Kostenlose und individuelle Beratung
- Hochwertige Produkte
- Kostenloser und schneller Versand





- TOP Bewertungen
- Exzelerter Kundenservice
- Über 20 Jahre Erfahrung



E-Mail: info@unidomo.de | Tel.: 04621 - 30 60 89 0 | www.unidomo.de



Sicherheitshinweise

-  Kinder, sowie Erwachsene mit körperlichen, geistigen und / oder sensorischen Einschränkungen dürfen nicht unbeaufsichtigt das Duschsystem benutzen. Personen die unter Alkohol- oder Drogeneinfluss stehen, dürfen das Duschsystem nicht benutzen.
-  Der Kontakt der Brausestrahlen mit empfindlichen Körperstellen (z. B. Augen) muss vermieden werden. Es muss ein ausreichender Abstand zwischen Brause und Körper eingehalten werden.
-  Das Duschsystem darf nur zur Bade-, Hygiene- und Körperreinigungszwecke eingesetzt werden.
-  Aus Sicherheitsgründen darf der in der Brause #28561000 eingebaute EcoSmart (Durchflussbegrenzer) nicht demontiert werden.

Montagehinweise

- Die Leitungen und die Armatur müssen nach den gültigen Normen montiert, gespült und geprüft werden.
- Die in den Ländern jeweils gültigen Installationsrichtlinien sind einzuhalten.
- Vor der Montage muss das Produkt auf Transportschäden untersucht werden. Nach dem Einbau werden keine Transport- oder Oberflächenschäden anerkannt.
- Das der Handbrause beigepackte Sieb **(A)** muss eingebaut werden, um Schmutzeinspülungen aus dem Leitungsnetz zu vermeiden. Schmutzeinspülungen können die Funktion beeinträchtigen und/oder zu Beschädigungen an Funktionsteilen der Handbrause führen, für hieraus ergebende Schäden haftet Hansgrohe nicht.

Technische Daten

Betriebsdruck:	max. 0,6 MPa
Empfohlener Betriebsdruck:	max. 0,1 - 0,4 MPa
(1 MPa = 10 bar = 147 PSI)	
Heißwassertemperatur:	max. 60 °C
Thermische Desinfektion:	max. 70 °C / 4 min

Das Produkt ist ausschließlich für Trinkwasser konzipiert!



Maße (siehe Seite 2)



Serviceteile (siehe Seite 5)







Bedienung (siehe Seite 5)



Reinigung (siehe Seite 6) und beiliegende Broschüre

Safety Notes

-  Children as well as adults with physical, mental and/or sensoric impairments must not use this shower system without proper supervision. Persons under the influence of alcohol or drugs are prohibited from using this shower system.
-  Do not allow the streams of the shower touch sensitive body parts (such as your eyes). An adequate distance must be kept between the shower and you.
-  The shower system may only be used for bathing, hygienic and body cleansing purposes.
-  For safety reasons, it is forbidden to remove the EcoSmart (flow limiter) installed in the shower #28561000.

Installation Instructions

- The pipes and the fixture must be installed, flushed and tested as per the applicable standards.
- The plumbing codes applicable in the respective countries must be observed.
- Prior to installation, inspect the product for transport damages. After it has been installed, no transport or surface damage will be honoured.
- The filter **(A)** must be insert to protect the hand shower against incoming dirt by pipework. Incoming dirt leads to defects or/and can damage parts of the hand shower; such caused faults voids all liability and guarantee claims.

Technical Data

Operating pressure:	max. 0,6 MPa
Recommended operating pressure:	max. 0,1 - 0,4 MPa
(1 MPa = 10 bar = 147 PSI)	
Hot water temperature:	max. 60 °C.
Thermal disinfection:	max. 70 °C / 4 min

The product is exclusively designed for drinking water!



Dimensions (see page 2)



Spare parts (see page 5)



Operation (see page 5)



Cleaning (see page 6) enclosed brochure

Montage siehe Seite 5



Assembly see page 5

Crometta 85 Multi
28563003

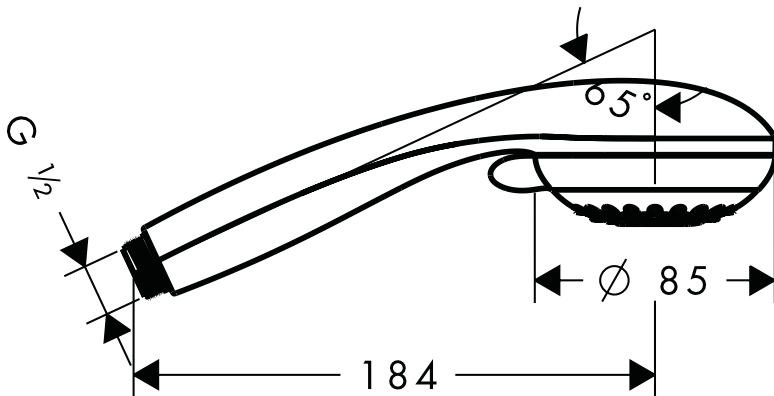
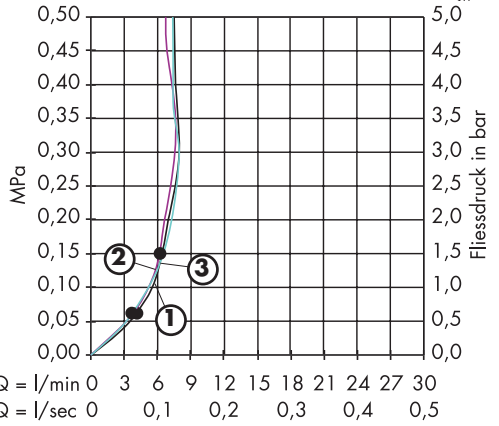
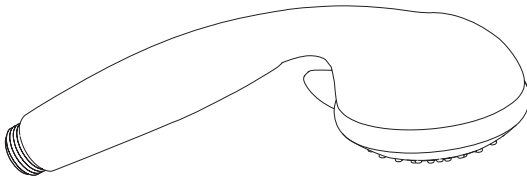
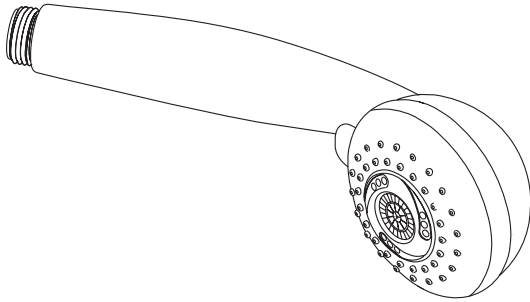



Crometta 85 Green
28561003

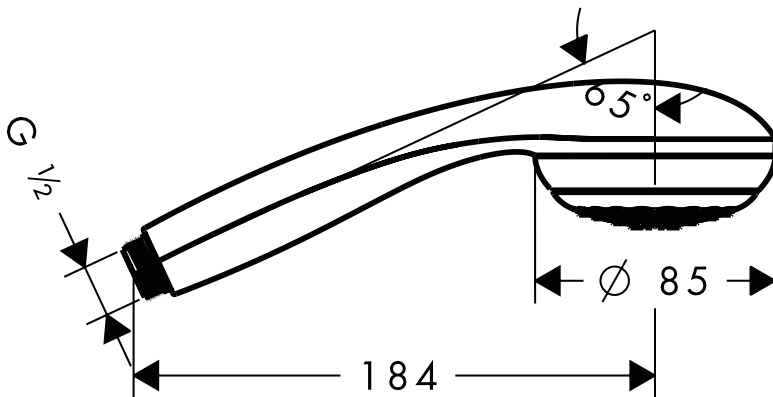
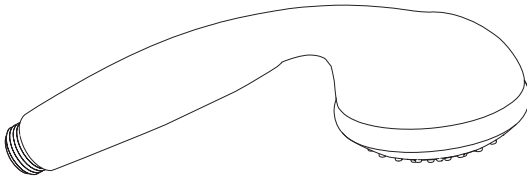
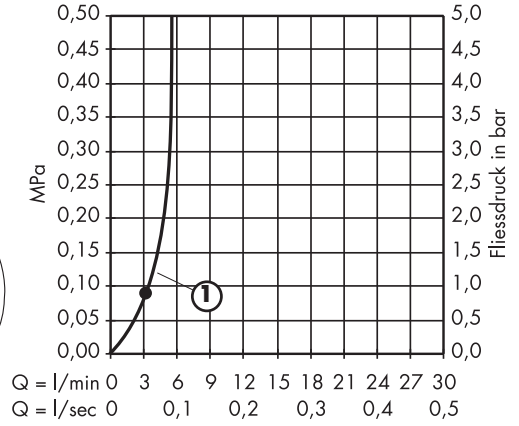
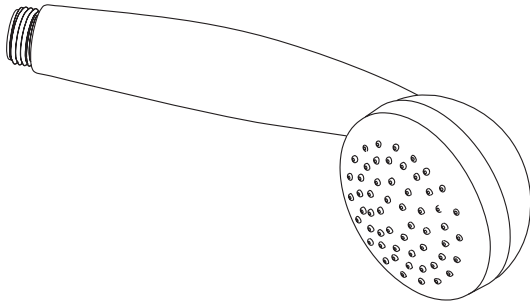

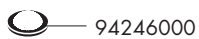
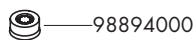
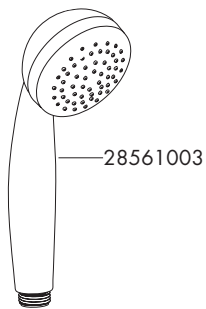
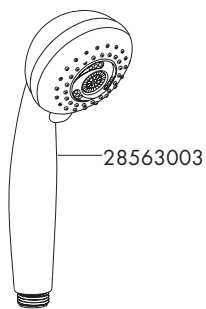
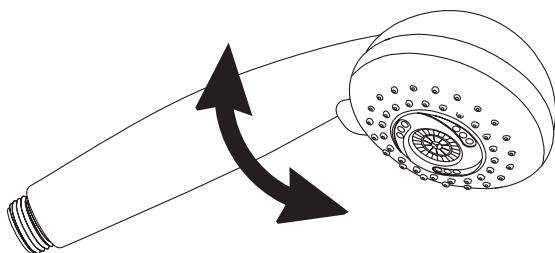
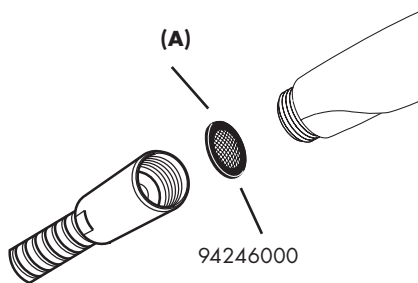

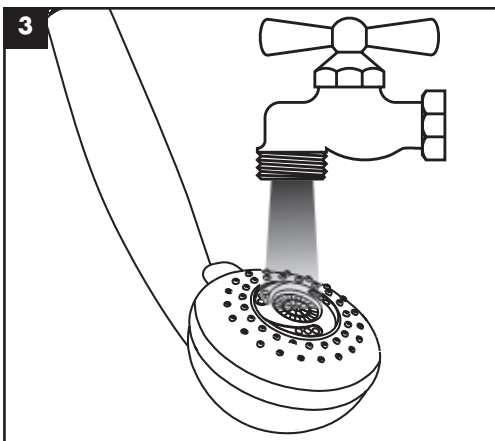
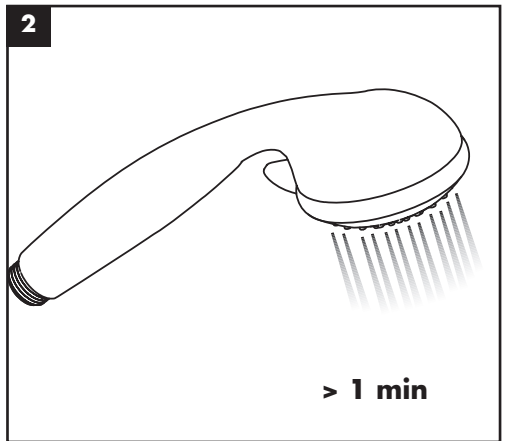
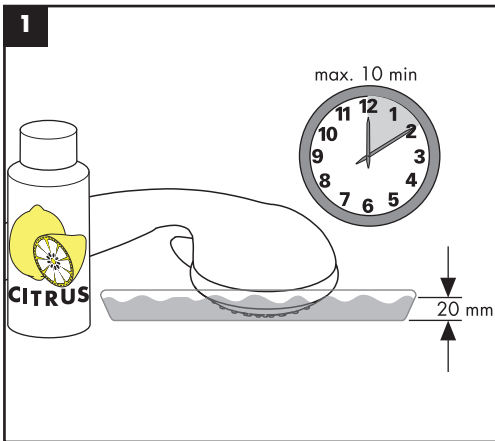
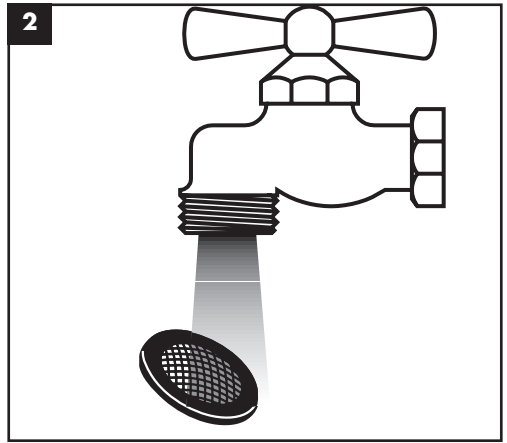
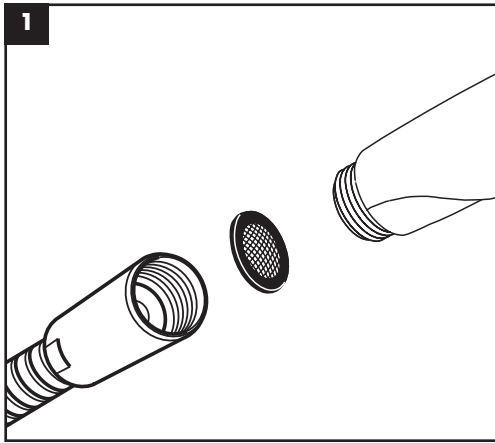

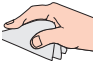

DE Einfach sauber: Kalk lässt sich von den Noppen ganz leicht abrubbeln.

EN Just clean: simply rub over the spray nozzles to remove lime scale.

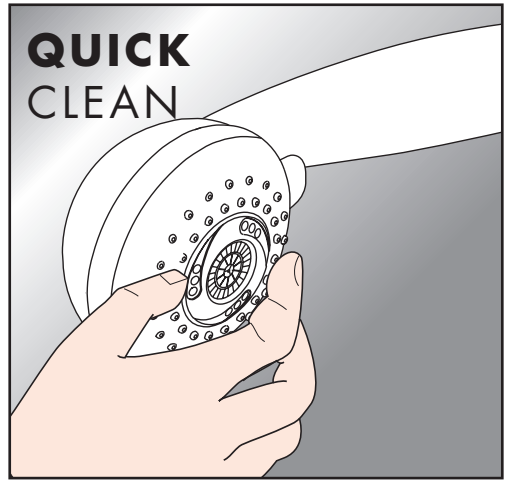

hansgrohe

Hansgrohe · Austraße 5 · 9 · D-77761 Schiltach · Telefon +49 (0) 78 36/51-1282 · Telefax +49 (0) 7836/51 1440
E-Mail: info@hansgrohe.com · Internet: www.hansgrohe.com

11/2014
9.04575.32