

DE	Gebrauchsanleitung / Montageanleitung	2
FR	Mode d'emploi / Instructions de montage	3
EN	Instructions for use / assembly instructions	4
IT	Istruzioni per l'uso / Istruzioni per l'installazione	5
ES	Modo de empleo / Instrucciones de montaje	6
NL	Gebruiksaanwijzing / Handleiding	7
DK	Brugsanvisning / Monteringsvejledning	8
PT	Instruções para uso / Manual de instalação	9
PL	Instrukcja obsługi / Instrukcja montażu	10
CS	Návod k použití / Montážní návod	11
SK	Návod na použitie / Montážny návod	12
ZH	用户手册 / 组装说明	13
RU	Руководство пользователя / Инструкция по монтажу	14
HU	Használati útmutató / Szerelési útmutató	15
FI	Käyttöohje / Asennusohje	16
SV	Bruksanvisning / Monteringsanvisning	17
LT	Vartotojo instrukcija / Montavimo instrukcijos	18
HR	Upute za uporabu / Uputstva za instalaciju	19
TR	Kullanım kılavuzu / Montaj kılavuzu	20
RO	Manual de utilizare / Instrucțiuni de montare	21
EL	Οδηγίες χρήσης / Οδηγία συναρμολόγησης	22
SL	Navodilo za uporabo / Navodila za montažo	23
ET	Kasutusjuhend / Paigaldusjuhend	24
LV	Lietošanas pamācība / Montāžas instrukcija	25
SR	Uputstvo za upotrebu / Uputstvo za montažu	26
NO	Bruksanvisning / Montasjeveiledning	27
BG	Инструкция за употреба / Ръководство за монтаж	28
SQ	Udhëzuesi i përdorimit / Udhëzime rreth montimit	29
AR	دليل الاستخدام / تعليمات التجميع	30

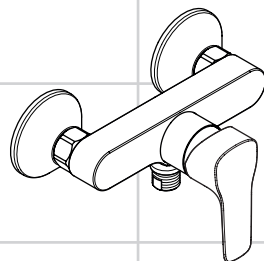

MySport
71262000

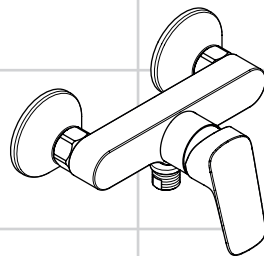

MyCube
71261000

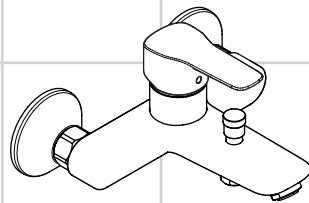

MySport
71242000

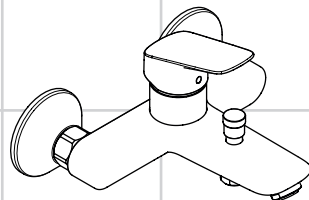

MyCube
71241000



Ihr Online-Fachhändler für:

hansgrohe

- Kostenlose und individuelle Beratung
- Hochwertige Produkte
- Kostenloser und schneller Versand



- TOP Bewertungen
- Exzelerter Kundenservice
- Über 20 Jahre Erfahrung



E-Mail: info@unidomo.de | Tel.: 04621 - 30 60 89 0 | www.unidomo.de



Sicherheitshinweise

-  Bei der Montage müssen zur Vermeidung von Quetsch- und Schnittverletzungen Handschuhe getragen werden.
-  Das Produkt darf nur zu Bade-, Hygiene- und Körperreinigungszwecken eingesetzt werden.
-  Große Druckunterschiede zwischen den Kalt- und Warmwasseranschlüssen müssen ausgeglichen werden.

Montagehinweise

- Vor der Montage muss das Produkt auf Transportschäden untersucht werden. Nach dem Einbau werden keine Transport- oder Oberflächenschäden anerkannt.
- Die Leitungen und die Armatur müssen nach den gültigen Normen montiert, gespült und geprüft werden.
- Die in den Ländern jeweils gültigen Installationsrichtlinien sind einzuhalten.
- Der im Wannenmischer eingesetzte Umsteller (Typ HC) ist als Einrichtung zur Absicherung gegen Rücksaugung ausgeführt. Daher muss sich die Unterkante des Umstellers min. 250 mm über dem höchstmöglichen Schmutzwasserspiegel befinden.

Technische Daten

Betriebsdruck:	max. 1 MPa
Empfohlener Betriebsdruck:	0,1 - 0,5 MPa
Prüfdruck:	1,6 MPa
(1 MPa = 10 bar = 147 PSI)	
Heißwassertemperatur:	max. 80 °C
Empfohlene Heißwassertemperatur:	65 °C
Thermische Desinfektion:	max. 70 °C / 4 min

Eigensicher gegen Rückfließen
Das Produkt ist ausschließlich für Trinkwasser konzipiert!

Symbolerklärung



Kein essigsäurehaltiges Silikon verwenden!



Justierung (siehe Seite 33)

Einstellen der Warmwasserbegrenzung. In Verbindung mit Durchlauferhitzern ist eine Warmwassersperre nicht zu empfehlen.



Wartung (siehe Seite 40)

Rückflussverhinderer müssen gemäß DIN EN 1717 regelmäßig in Übereinstimmung mit nationalen oder regionalen Bestimmungen (DIN 1988 einmal jährlich) auf ihre Funktion geprüft werden.

Maße (siehe Seite 34)



Durchflussdiagramm

(siehe Seite 34)



Bedienung (siehe Seite 38)



Serviceteile (siehe Seite 36)



Reinigung

siehe beiliegende Broschüre.



Prüfzeichen (siehe Seite 40)





Störung	Ursache	Abhilfe
Wenig Wasser	- Rückflussverhinderer sitzt fest - Siebdichtung der Brause verschmutzt	- Rückflussverhinderer austauschen - Siebdichtung zwischen Brause und Schlauch reinigen
Armatur schwergängig	- Kartusche defekt, verkalkt	- Kartusche austauschen
Armatur tropft	- Kartusche defekt	- Kartusche austauschen
Zu niedrige Warmwassertemperatur	- Warmwasserbegrenzung falsch eingestellt	- Warmwasserbegrenzung einstellen
Durchlauferhitzer schaltet nicht ein	- Drossel in der Handbrause nicht ausgebaut - Siebdichtung der Brause verschmutzt - Rückflussverhinderer sitzt fest	- Drossel aus der Handbrause entfernen - Siebdichtung zwischen Brause und Schlauch reinigen - Rückflussverhinderer austauschen



Montage siehe Seite 31



Consignes de sécurité

-  Lors du montage, porter des gants de protection pour éviter toute blessure par écrasement ou coupure.
-  Le système de douche ne doit servir qu'à se laver et à assurer l'hygiène corporelle.
-  Il est conseillé d'équilibrer les pressions de l'eau chaude et froide.

Instructions pour le montage

- Avant son montage, s'assurer que le produit n'a subi aucun dommage pendant le transport. Après le montage, tout dommage de transport ou de surface ne pourra pas être reconnu.
- Les conduites et la robinetterie doivent être montés, rincés et contrôlés selon les normes en vigueur.
- Les directives d'installation en vigueur dans le pays concerné doivent être respectées.
- L'inverseur (type HC) utilisé dans le mitigeur bain-douche est conçu en tant que protection contre la réaspiration. C'est la raison pour laquelle le bord inférieur de l'inverseur doit se trouver au moins à 250 mm au-dessus du niveau d'eau usée le plus haut possible.

Informations techniques

Pression de service autorisée:	max. 1 MPa
Pression de service conseillée:	0,1 - 0,5 MPa
Pression maximum de contrôle:	1,6 MPa
(1 MPa = 10 bar = 147 PSI)	
Température d'eau chaude:	max. 80 °C
Température recommandée:	65 °C
Désinfection thermique:	max. 70 °C / 4 min

Avec dispositif anti-retour
Le produit est exclusivement conçu pour de l'eau potable!

Description du symbole



Ne pas utiliser de silicone contenant de l'acide acétique!



Étalonnage (voir pages 33)

Réglage de la limitation d'eau chaude. En liaison avec les chauffe-eau, un blocage de l'eau chaude n'est pas recommandable.



Entretien (voir pages 40)

Les clapets anti-retour doivent être examinés régulièrement conformément à la norme EN 1717 ou conformément aux dispositions nationales ou régionales quant à leur fonction (au moins une fois par an).



Dimensions (voir pages 34)



Diagramme du débit

(voir pages 34)



Instructions de service (voir pages 38)



Pièces détachées (voir pages 36)



Nettoyage

voir la brochure ci-jointe.



Classification acoustique et débit (voir pages 40)



Dysfonctionnement	Origine	Solution
Pas assez d'eau	- Clapet anti-retour bloque - Joint-filtre de douchette encrassé	- Changez le clapet antiretour - Nettoyer le joint-filtre entre la douchette et le flexible
Dureté de fonctionnement	- Cartouche défectueuse, entartrée	- Changer la cartouche
Le mitigeur goutte	- Cartouche défectueuse	- Changer la cartouche
Température d'eau chaude trop basse, pas d'eau froide	- Limiteur de température mal positionné	- Positionner le limiteur de température
La chauffe-eau instantané ne s'allume pas	- Réducteur de débit non démonté - Joint-filtre de douchette encrassé - Clapet anti-retour bloque	- Démontez le réducteur de débit de la douchette - Nettoyer le joint-filtre entre la douchette et le flexible - Changez le clapet antiretour



Montage voir pages 31



Safety Notes

-  Gloves should be worn during installation to prevent crushing and cutting injuries.
-  The shower system may only be used for bathing, hygienic and body cleaning purposes.
-  The hot and cold supplies must be of equal pressures.

Installation Instructions

- Prior to installation, inspect the product for transport damages. After it has been installed, no transport or surface damage will be honoured.
- The pipes and the fixture must be installed, flushed and tested as per the applicable standards.
- The plumbing codes applicable in the respective countries must be observed.
- The diverter (type HC) installed in the bath mixer is designed as an anti-retraction device. For this reason, the lower edge of the diverter must be at least 250 mm above the highest possible dirty water level.

Technical Data

Operating pressure:	max. 1 MPa
Recommended operating pressure:	0,1 - 0,5 MPa
Test pressure:	1,6 MPa
(1 MPa = 10 bar = 147 PSI)	
Hot water temperature:	max. 80 °C
Recommended hot water temp.:	65 °C
Thermal disinfection:	max. 70 °C / 4 min

Safety against backflow

The product is exclusively designed for drinking water!

Symbol description



Do not use silicone containing acetic acid!



Adjustment (see page 33)

To adjust the hot water limiter. Using a hot water limiter in combination with a continuous flow water heater is not recommended.



Maintenance (see page 40)

The check valves must be checked regularly according to DIN EN 1717 in accordance with national or regional regulations (at least once a year).



Dimensions (see page 34)



Flow diagram

(see page 34)



Operation (see page 38)



Spare parts (see page 36)



Cleaning

see enclosed brochure.



Test certificate (see page 40)



Fault	Cause	Remedy
Insufficient water	- check valve hasn't moved back - Shower filter seal dirty	- Exchange check valves - Clean filter seal between shower and hose
Mixer stiff	- Cartridge defective, calcified	- Exchange cartridge
Mixer dripping	- Cartridge defective	- Exchange cartridge
Hot water temperature too low	- Hot water limiter incorrectly set	- Set hot water limiter
Instantaneous heater didn't work	- Flow limiter in handshower isn't removed - Shower filter seal dirty - check valve hasn't moved back	- Remove flow limiter - Clean filter seal between shower and hose - Exchange check valves



Assembly see page 31



Indicazioni sulla sicurezza

-  Durante il montaggio, per evitare ferite da schiacciamento e da taglio bisogna indossare guanti protettivi.
-  Il sistema doccia deve essere utilizzato esclusivamente per l'igiene del corpo.
-  Attenzione! Compensare le differenze di pressione tra i collegamenti dell'acqua fredda e dell'acqua calda.

Istruzioni per il montaggio

- Prima del montaggio è necessario controllare che non ci siano stati danni durante il trasporto. Una volta eseguito il montaggio, non verranno riconosciuti eventuali danni di trasporto o delle superfici.
- Montare, lavare e controllare tubature e rubinetteria rispettando le norme correnti.
- Vanno rispettate le direttive di installazione nazionali vigenti nel rispettivo paese.
- Il deviatore (tipo HC) impiegato nel miscelatore della vasca è eseguito come dispositivo di sicurezza contro un'aspirazione di riflusso. Pertanto il bordo inferiore del deviatore deve trovarsi almeno 250 mm sopra il livello massimo possibile dell'acqua sporca.

Dati tecnici

Pressione d'uso:	max. 1 MPa
Pressione d'uso consigliata:	0,1 - 0,5 MPa
Pressione di prova:	1,6 MPa
(1 MPa = 10 bar = 147 PSI)	
Temperatura dell'acqua calda:	max. 80 °C
Temp. dell'acqua calda consigliata:	65 °C
Disinfezione termica:	max. 70 °C / 4 min

Sicurezza antiriflusso

Il prodotto è concepito esclusivamente per acqua potabile!

Descrizione simbolo



Non utilizzare silicone contenente acido acetico!



Taratura (vedi pagg. 33)

Regolazione del limitatore di erogazione d'acqua calda. Un limitatore di erogazione di acqua calda in combinazione con le caldaie istantanee non è consigliabile.



Manutenzione (vedi pagg. 40)

La valvola di non ritorno deve essere controllata regolarmente come da DIN EN 1717, secondo le normative nazionali e regionali (almeno una volta all'anno).



Ingombri (vedi pagg. 34)



Diagramma flusso

(vedi pagg. 34)



Procedura (vedi pagg. 38)



Parti di ricambio (vedi pagg. 36)



Pulitura

vedi il prospetto accluso.



Segno di verifica (vedi pagg. 40)

Problema	Possibile causa	Rimedio
Scarsità d'acqua	- Valvola antiriflusso non funziona correttamente	- Sostituire la valvola antiriflusso
	- Guarnizione del filtro della doccia sporca	- Pulire la guarnizione del filtro tra doccia e flessibile
Miscelatore duro	- Cartuccia difettosa	- Sostituire la cartuccia
Miscelatore gocciola	- Cartuccia difettosa	- Sostituire la cartuccia
Temperatura dell'acqua calda	- Limitazione dell'acqua calda regolata male	- Regolare la limitazione dell'acqua calda
La caldaia istantanea non lavora	- Il limitatore di portata non è stato smontato dalla doccia	- Smontare il limitatore di portata dalla doccia
	- Guarnizione del filtro della doccia sporca	- Pulire la guarnizione del filtro tra doccia e flessibile
	- Valvola antiriflusso non funziona correttamente	- Sostituire la valvola antiriflusso



Montaggio vedi pagg. 31



Indicaciones de seguridad

- ⚠ Durante el montaje deben utilizarse guantes para evitar heridas por aplastamiento o corte.
- ⚠ La grifería solo debe ser utilizada para fines de baño, higiene y limpieza corporal.
- ⚠ Grandes diferencias de presión en servicio entre agua fría y agua caliente deben equilibrarse.

Indicaciones para el montaje

- Antes del montaje se debe examinarse el producto contra daños de transporte. Después de la instalación so se reconoce ningún daño de transporte o de superficie.
- Los conductos y la grifería deben montarse, lavarse y comprobarse según las normas vigentes.
- Es obligatorio el cumplimiento de las directrices de instalación vigentes en el país respectivo.
- El cambiador (tipo HC) integrado en la batería de la bañera es un seguro contra la reabsorción. Por lo tanto el borde inferior del cambiador debe encontrarse al menos a 250 mm sobre el nivel más alto posible de agua usada.

Datos técnicos

Presión en servicio:	max. 1 MPa
Presión recomendada en servicio:	0,1 - 0,5 MPa
Presión de prueba:	1,6 MPa
(1 MPa = 10 bar = 147 PSI)	
Temperatura del agua caliente:	max. 80 °C
Temp. recomendada del agua caliente:	65 °C
Desinfección térmica:	max. 70 °C / 4 min

Seguro contra el retorno

El producto ha sido concebido exclusivamente para agua potable.

Descripción de símbolos



No utilizar silicona que contiene ácido acético!



Ajuste (ver página 33)

Ajuste del límite de agua caliente. En combinación con calentadores continuos no es recomendable utilizar un bloqueo de agua caliente.



Mantenimiento (ver página 40)

Las válvulas anti-retorno tienen que ser controladas regularmente según la norma DIN EN 1717, en acuerdo con las regulaciones nacionales o regionales (una vez al año, por lo menos).



Dimensiones (ver página 34)



Diagrama de circulación (ver página 34)



Manejo (ver página 38)



Repuestos (ver página 36)



Limpiar

ver el folleto adjunto.



Marca de verificación (ver página 40)



Problema	Causa	Solución
Sale poca agua	- válvula anti-retorno cerrada - Filtro de la teleducha sucio	- cambiar válvula anti-retorno - Limpiar / Cambiar filtro entre flexo y teleducha
Manecilla va dura	- cartucho dañado	- cambiar el cartucho
Grifo pierde agua	- cartucho dañado	- cambiar el cartucho
Temperatura del agua caliente demasiado baja	- tope de agua caliente mal	- ajustar tope
Calentador instantáneo no se enciende	- no se ha quitado limitador de caudal de la teleducha - Filtro de la teleducha sucio - válvula anti-retorno cerrada	- quitar limitador de caudal - Limpiar / Cambiar filtro entre flexo y teleducha - cambiar válvula anti-retorno



Montaje ver página 31



Veiligheidsinstructies

-  Bij de montage moeten ter voorkoming van kniel- en snijwonden handschoenen worden gedragen.
-  Het douchesysteem mag alleen voor het wassen, hygiënische doeleinden en voor de lichaamreiniging worden gebruikt.
-  Grote drukverschillen tussen de koud- en warmwater-toevoer dienen vermeden te worden.

Montage-instructies

- Vóór de montage moet het product gecontroleerd worden op transportschade. Na de inbouw wordt geen transport- of oppervlakteschade meer aanvaard.
- De leidingen en armaturen moeten gemonteerd, gespeeld en gecontroleerd worden volgens de geldige normen.
- De in de overeenkomstige landen geldende installatie-richtlijnen moeten nageleefd worden.
- De in de badmengkraan gebruikte regelaar (type HC) is uitgevoerd als inrichting ter beveiliging tegen terugzuiging. Daarom moet de onderkant van de regelaar zich min. 250 mm boven de hoogst mogelijke vuilwaterspiegel bevinden.

Technische gegevens

Werkdruk: max.	max. 1 MPa
Aanbevolen werkdruk:	0,1 - 0,5 MPa
Getest bij:	1,6 MPa
(1 MPa = 10 bar = 147 PSI)	
Temperatuur warm water:	max. 80 °C
Aanbevolen warm water temp.:	65 °C
Thermische desinfectie:	max. 70 °C / 4 min

Beveiligd tegen terugstromen
Het product is uitsluitend ontworpen voor drinkwater!

Symboolbeschrijving



Gebruik geen zuurhoudende silicone!



Instellen (zie blz. 33)

Instellen van de warmwaterbegrenzing. In combinatie met een doorstromer is een warmwaterblokering niet aanbevelenswaardig.



Onderhoud (zie blz. 40)

Keerkleppen moeten volgens DIN EN 1717 regelmatig en volgens plaatselijk geldende eisen op het functioneren gecontroleerd worden. (Tenminste een keer per jaar).



Maten (zie blz. 34)



Doorstroombiagram

(zie blz. 34)



Bediening (zie blz. 38)



Service onderdelen (zie blz. 36)



Reinigen

zie bijgevoegde brochure.



Keurmerk (zie blz. 40)

Storing	Oorzaak	Oplossing
Weinig water	- Terugslagklep zit vast - Zeefdichting handdouche verstopt	- Terugslagklep uitwisselen - Zeefdichting handdouche reinigen
Bediening zwaar	- Kardoes defect of verkalkt	- Kardoes uitwisselen
Mengkraan lekt	- Kardoes defect	- Kardoes uitwisselen
Temperatuur van warm water te laag	- Heetwaterbegrenzer verkeerd ingesteld	- Heetwaterbegrenzer instellen
Doorstroombi-diagram schakelt niet in	- Begrenzer van handdouche niet verwijderd - Zeefdichting handdouche verstopt - Terugslagklep zit vast	- Begrenzer uit handdouche verwijderen - Zeefdichting handdouche reinigen - Terugslagklep uitwisselen



Montage zie blz. 31



Sikkerhedsanvisninger

- △ Ved monteringen skal der bruges handsker for at undgå kvæstelser og snitsår.
- △ Brusersystemet må kun bruges til bade-, hygiejne og rengøringsformål.
- △ Større trykforskelte mellem koldt og varmt vand bør udjævnes.

Monteringsanvisninger

- Før monteringen skal produktet kontrolleres for transportskader. Efter monteringen godkendes transportskader eller skader på overfladen ikke længere.
- Ledningerne og armaturerne skal monteres, skylles og kontrolleres iht. de gældende standarder.
- Installationsbestemmelserne, der gælder i det enkelte land, skal overholdes.
- Omstilleren (type HC), som er integreret i blanderen, er konstrueret som sikring mod retursugning. Derfor skal omstillerens underkant være mindst 250 mm over det højst mulige snavsevandsniveau.

Tekniske data

Driftstryk:	max. 1 MPa
Anbefalet driftstryk:	0,1 - 0,5 MPa
Prøvetryk:	1,6 MPa
(1 MPa = 10 bar = 147 PSI)	
Varmtvands-temperatur:	max. 80 °C
Anbefalet varmtvands-temperatur:	65 °C
Termisk desinfektion:	max. 70 °C / 4 min

Med indbygget kontraventil
Produktet er udelukkende beregnet til drikkevand!

Symbolbeskrivelse



Der må ikke benyttes eddikesyreholdig silikone!



Forindstilling (se s. 33)

Indstilling af varmvandsbegrænsningen. I forbindelse med gennemstrømningsvandvarmere anbefaler vi ikke en varmvandsspærre.



Service (se s. 40)

Ifølge DIN EN 1717 skal gennemstrømningsbegrænsere i overensstemmelse med nationale regler afprøves regelmæssigt (mindst en gang om året).



Målene (se s. 34)

Gennemstrømningsdiagram

(se s. 34)



Brugsanvisning (se s. 38)



Reserve dele (se s. 36)



Rengøring

se venligst den vedlagte brochure.





Godkendelse (se s. 40)

Fejl	Årsag	Hjælp
For lidt vand	- Kontraventilen hænger - Sien mellem bruser og slange er snavset	- Udskift kontraventil - Rengør sien mellem bruser og slange
Grebet går trægt	- Kartusche defekt, tilkalket	- Udskift kartusche
Armaturet drypper	- Defekt kartusche	- Udskift kartusche
For lav varmtvands-temperatur	- Varmtvandsbegrænsningen er forkert indstillet	- Indstil varmtvandsbegrænsningen
Vandvarmeren går ikke i gang	- Vandsparen i håndbruseren er ikke fjernet - Sien mellem bruser og slange er snavset - Kontraventilen hænger	- Afmonter vandsparen i håndbruseren - Rengør sien mellem bruser og slange - Udskift kontraventil





Avisos de segurança

-  Durante a montagem devem ser utilizadas luvas de protecção, de modo a evitar ferimentos resultantes de entalamentos e de cortes.
-  O sistema de duche só pode ser utilizado para fins de higiene pessoal.
-  Grandes diferenças entre as pressões das águas quente e fria devem ser compensadas.

Avisos de montagem

- Antes da montagem deve-se controlar o produto relativamente a danos de transporte. Após a montagem não são aceites quaisquer danos de transporte ou de superfície.
- As tubagens e a torneira têm que ser montadas, enxaguadas e verificadas de acordo com as normas em vigor.
- A prescrições de instalação válidas nos respetivos países devem ser respeitadas.
- O inversor (tipo HC), utilizado na misturadora de monobloco para banheira, funciona como proteção contra reaspiração. Por este motivo, o bordo inferior do inversor deve situar-se pelo menos 250 mm acima do nível máximo da água suja.

Dados Técnicos

Pressão de funcionamento:	max. 1 MPa
Pressão de func. recomendada:	0,1 - 0,5 MPa
Pressão testada:	1,6 MPa
(1 MPa = 10 bar = 147 PSI)	
Temperatura da água quente:	max. 80 °C
Temp. água quente recomendada:	65 °C
Desinfecção térmica:	max. 70 °C / 4 min

Função anti-retorno e anti-vácuo

Este produto foi única e exclusivamente concebido para água potável!

Descrição do símbolo



Não utilizar silicone que contenha ácido acético!



Afinação (ver página 33)

Ajuste do limitador de água quente. Em combinação com um esquentador, não é recomendável o uso de um bloqueio de água quente.



Manutenção (ver página 40)

As válvulas anti-retorno devem ser verificadas regularmente de acordo com a DIN EN 1717 segundo os regulamentos nacionais ou regionais (pelo menos uma vez por ano).



Medidas (ver página 34)



Fluxograma (ver página 34)



Funcionamento (ver página 38)



Peças de substituição (ver página 36)



Limpeza

consultar a seguinte brochura.



Marca de controlo (ver página 40)

Falha	Causa	Solução
Água insuficiente	- Válvula anti-retorno está presa - Filtro do vedante do chuveiro sujo	- Trocar a válvula anti-retorno - Limpar o filtro entre o chuveiro e o tubo flexível
Misturadora perra	- Cartucho defeituoso, calcificado	- Substituir o cartucho
Misturadora a pingar	- Cartucho defeituoso	- Substituir o cartucho
Temperatura da água quente muito baixa	- O limitador de temperatura está incorrectamente colocado	- Regular o limitador de temperatura
O esquentador instantâneo não funciona	- O limitador de caudal não foi retirado - Filtro do vedante do chuveiro sujo - Válvula anti-retorno está presa	- Retirar o limitador de caudal - Limpar o filtro entre o chuveiro e o tubo flexível - Trocar a válvula anti-retorno





⚠ Wskazówki bezpieczeństwa

- ⚠ Aby uniknąć zranień, takich jak zgniecenia czy przecięcia, podczas montażu należy nosić rękawice.
- ⚠ Prysznic może być używany tylko do kąpieli, higieny i czyszczenia ciała.
- ⚠ Znaczne różnice ciśnień na dopływach ciepłej i zimnej wody muszą zostać wyrównane.

Wskazówki montażowe

- Przed montażem należy skontrolować produkt pod kątem szkód transportowych. Po montażu nie widać żadnych szkód transportowych ani szkód na powierzchni.
- Przewody i armatura muszą być montowane, płukane i kontrolowane według obowiązujących norm.
- Należy przestrzegać wytycznych instalacyjnych obowiązujących w danym kraju.
- Przelącznik (typu HC), zastosowany w mieszaczku wannowym, został zaprojektowany jako sprzęt do zabezpieczenia przed zasysaniem wstecznym. Z tego względu, dolna krawędź przelącznika musi się znajdować co najmniej 250 mm ponad najwyższym możliwym poziomem brudnej wody.

Dane techniczne

Ciśnienie robocze:	maks. 1 MPa
Zalecane ciśnienie robocze:	0,1 - 0,5 MPa
Ciśnienie próbne:	1,6 MPa
(1 MPa = 10 bary = 147 PSI)	
Temperatura wody gorącej:	maks. 80 °C
Zalecana temperatura wody gorącej:	65 °C
Dezynfekcja termiczna:	maks. 70 °C / 4 min

Zabezpieczony przed przepływem zwrotnym
Produkt przeznaczony wyłącznie do wody pitnej!

Opis symbolu



Nie stosować silikonów zawierających kwas octowy!



Ustawianie (patrz strona 33)

Ustawianie ogranicznika ciepłej wody. Używanie ogranicznika temperatury wody w połączeniu z przepływowym podgrzewaczem wody nie jest zalecane.



Konserwacja (patrz strona 40)

Działanie zabezpieczeń przed przepływem zwrotnym, zgodnie z normą DIN EN 1717 i miejscowymi przepisami, musi być kontrolowane (DIN 1988, raz w roku).



Wymiary (patrz strona 34)



Schemat przepływu

(patrz strona 34)



Obsługa (patrz strona 38)



Części serwisowe (patrz strona 36)



Czyszczenie

patrz dołączona broszura.



Znak jakości (patrz strona 40)



Usterka	Przyczyna	Pomoc
Mała ilość wody	- Zablokowane zabezpieczenie przed przepływem zwrotnym - Zabrudzona uszczelka z sitkiem w prysznicu	- Wymienić zabezpieczenie przed przepływem zwrotnym - Oczyszczyć uszczelkę z sitkiem pomiędzy prysznicem a węzłem
Uchwyt armatury pracuje z wysiłkiem	- Uszkodzony wkład, zakamieniony	- Wymiana wkładu
Armatura cieknie	- Uszkodzony wkład	- Wymiana wkładu
Za niska temperatura ciepłej wody	- Niewłaściwe ustawienie ogranicznik ciepłej wody	- Ustawić ogranicznik ciepłej wody
Przepływowy podgrzewacz wody nie załącza się	- Dławik przepływu nie został usunięty z prysznicu ręcznego - Zabrudzona uszczelka z sitkiem w prysznicu - Zablokowane zabezpieczenie przed przepływem zwrotnym	- Usunąć dławik z prysznicu ręcznego - Oczyszczyć uszczelkę z sitkiem pomiędzy prysznicem a węzłem - Wymienić zabezpieczenie przed przepływem zwrotnym



Montaż patrz strona 31



Bezpečnostní pokyny

-  Pro zabránění řezným zraněním a pohmožděninám je nutné při montáži nosit rukavice.
-  Produkt smí být používán pouze ke koupání a za účelem tělesné hygieny.
-  Je nutné vyrovnat velké rozdíly tlaku mezi přípoji studené a teplé vody.

Pokyny k montáži

- Před montáží je třeba produkt zkontrolovat, zda nebyl při transportu poškozen. Po zabudování nebudou uznány žádné škody způsobené transportem nebo poškození povrchu.
- Vedení a armatura musí být namontovány, propláchnuty a otestovány podle platných norem.
- Je třeba dodržovat montážní pravidla platné v dané zemi.
- Přepínač vanové baterie (typu HC) je koncipován jako zařízení bránící zpětnému sání. Proto se musí spodní hrana přepínače nacházet alespoň 250 mm nad nejvyšší možnou hladinou znečištěné vody.

Technické údaje

Provozní tlak:	max. 1 MPa
Doporučený provozní tlak:	0,1 - 0,5 MPa
Zkušební tlak:	1,6 MPa
(1 MPa = 10 bar = 147 PSI)	
Teplota horké vody:	max. 80 °C
Doporučená teplota horké vody:	65 °C
Tepelná desinfekce:	max. 70 °C / 4 min

Vlastní jištění proti zpětnému nasátí.

Výrobky Hansgrohe jsou vhodné pro přímý kontakt s pitnou vodou.

Popis symbolů



Nepoužívat silikon s obsahem kyseliny octové!



Nastavení (viz strana 33)

Nastavení omezovače teplé vody. Ve spojení s průtokovým ohřivačem se použití uzávěru teplé vody nedoporučuje.



Údržba (viz strana 40)

U zpětných ventilů se musí podle DIN EN 1717 v souladu s národními nebo regionálními předpisy testovat jejich funkčnost (alespoň jednou ročně).



Rozměry (viz strana 34)



Diagram průtoku

(viz strana 34)



Ovládání (viz strana 38)



Servisní díly (viz strana 36)



Čištění

viz příložená brožura.



Zkušební značka (viz strana 40)

Porucha	Příčina	Odstranění
Málo vody	- Zpětný ventil je zablokovaný - Sítko v těsnění u sprchy zanesené	- Vyměnit zpětný ventil - Vyčistit sítko v těsnění mezi sprchou a hadicí
Armatura jde ztěžka	- Kartuše je vadná, zanesená vodním kamenem	- Kartuši vyměnit
Armatura odkapává	- Kartuše je vadná	- Kartuši vyměnit
Nízká teplota teplé vody	- Špatně nastavená zarážka pro teplou vodu	- Seřadit zarážku pro teplou vodu
Průtokový ohřivač nezapíná	- Není odstraněn kroužek ze sprchy - Sítko v těsnění u sprchy zanesené	- Odstranit kroužek ze sprchy - Vyčistit sítko v těsnění mezi sprchou a hadicí
	- Zpětný ventil je zablokovaný	- Vyměnit zpětný ventil



Montáž viz strana 31



⚠ Bezpečnostné pokyny

- ⚠ Pri montáži musíte nosiť rukavice, aby ste predišli pomliaždeninám a rezným poraneniam.
- ⚠ Produkt sa smie používať len na kúpanie a telesnú hygienu.
- ⚠ Veľké rozdiely v tlaku medzi prípojkami studenej a teplej vody musia byť vyrovnané.

Pokyny pre montáž

- Pred montážou musíte produkt skontrolovať, či nebol počas transportu poškodený. Po zabudovaní nebudú uznané žiadne škody spôsobené transportom alebo poškodenia povrchu.
- Ledningarna och blandaren måste monteras, spolars igenom och kontrolleras enligt de gällande normerna.
- Je potrebné dodržiavať smernice o inštalácii, ktoré sú práve teraz platné v krajinách.
- Prestavovač (typ HC) použitý vo vaňovom zmiešavači je vyhotovený ako zariadenie na zaistenie proti spätnému nasávaniu. Preto sa musí spodná hrana prestavovača nachádzať min. 250 mm nad najvyššie možnou hladinou znečistenej vody.

Technické údaje

Prevádzkový tlak:	max. 1 MPa
Doporučený prevádzkový tlak:	0,1 - 0,5 MPa
Skúšobný tlak:	1,6 MPa
(1 MPa = 10 bar = 147 PSI)	
Teplota teplej vody:	max. 80 °C
Doporučená teplota teplej vody:	65 °C
Termická dezinfekcia:	max. 70 °C / 4 min

Vlastná poisťka proti spätnému nasatiu.
Výrobok je koncipovaný výhradne pre pitnú vodu!

Popis symbolov



Nepoužívať silikón s obsahom kyseliny octovej!



Nastavenie (viď strana 33)

Nastavenie obmedzenia teplej vody. V spojení s prietokovými ohrievačmi sa neodporúča použitie obmedzovača teplej vody.



Údržba (viď strana 40)

Pri spätných ventiloch sa musí podľa DIN EN 1717 v súlade s národnými alebo regionálnymi predpismi testovať ich funkčnosť (aspoň raz ročne).



Rozmery (viď strana 34)



Diagram prietoku

(viď strana 34)



Obsluha (viď strana 38)



Servisné diely (viď strana 36)



Čistenie

nájdete v priloženej brožúre.



Osvedčenie o skúške (viď strana 40)

Porucha	Príčina	Pomoc
Málo vody	- Obmedzovač spätného nasatia je zablokovaný - Sitko v tesnení sprchy je znečistené	- Vymeniť obmedzovač spätného nasatia - Vyčistiť sitko tesnení medzi sprchou a hadicou
Armatúra "chodí" ťažko	- Kartuša je poškodená, vápenaté usadeniny	- Vymeniť kartušu
Z armatúry kvapká voda	- Kartuša je poškodená	- Vymeniť kartušu
Nízka teplota teplej vody	- Nesprávne nastavená zarážka na teplú vodu	- Nastavenie zarážky na teplú vodu
Prietokový ohrievač nezapína	- Nie je odstránený krúžok zo sprchy - Sitko v tesnení sprchy je znečistené - Obmedzovač spätného nasatia je zablokovaný	- Odstrániť krúžok zo sprchy - Vyčistiť sitko tesnení medzi sprchou a hadicou - Vymeniť obmedzovač spätného nasatia



Montáž viď strana 31



安全技巧

- △ 装配时为避免挤压和切割受伤，必须戴上手套。
- △ 淋浴系统只允许作为洗浴、卫生和洁身之用。
- △ 冷热水管间过大的压力差必须予以平衡。

安装提示

- 安装前必须检查产品是否受到运输损害。安装后将不认可运输损害或表面损伤。
- 管道和阀门必须根据通用标准进行安装、冲洗和检查。
- 请遵守当地国家现行的安装规定。
- 安装在冷热水混合开关中的转换装置（HC 型）用于防止水流回吸。所以转换装置下边缘必须至少高于脏水反水弯 250 mm。

技术参数

工作压力:	最大 1 MPa
推荐工作压力:	0,1 - 0,5 MPa
测试压强:	1,6 MPa
(1 MPa = 10 bar = 147 PSI)	
热水温度:	最大 80°C
推荐热水温度:	65°C
热力消毒:	最大 70°C / 4 分钟

自动防止回流

该产品专为饮用水设计！

符号说明



请勿使用含有乙酸的硅！



调节 (参见第页 33)

热水温度调节。如果使用即热式喷头，则不建议安装热水阀门。



保养 (参见第页 40)

单向阀必须在符合国家或当地的法律的情况下按照 DIN EN 1717 定期检查（至少一年一次）。



大小 (参见第页 34)



流量示意图
(参见第页 34)



操作 (参见第页 38)



备用零件 (参见第页 36)



清洗
附有手册



检验标记 (参见第页 40)



问题	原因	补救
龙头出水量小	- 单向阀装反 - 花洒滤网有垃圾堵塞	- 正确安装单向阀 - 清洗花洒和软管间的过滤密封件
龙头不灵活	- 阀芯损坏、结垢	- 更换阀芯
龙头滴水	- 阀芯损坏	- 更换阀芯
热水温度过低	- 热水控制器设置错误	- 设置热水控制器
燃气热水器不工作	- 手持花洒的流量限制器没有去除 - 花洒滤网有垃圾堵塞	- 去除流量限制器 - 清洗花洒和软管间的过滤密封件
	- 单向阀装反	- 正确安装单向阀



安装 参见第页 31



Указания по технике безопасности

-  Во время монтажа следует надеть перчатки во избежание прищемления и порезов.
-  Изделие разрешается использовать только в гигиенических целях: для принятия ванны и личной гигиены.
-  донного клапа. Перед установкой смесителя необходимо регулировочными кранами выровнять давление холодной и горячей воды при помощи вентилей регулирующих подачу воды в квартиру.

Указания по монтажу

- Перед монтажом следует проверить изделие на предмет повреждений при перевозке. После монтажа претензии о возмещении ущерба за повреждения при перевозке или повреждения поверхностей не принимаются.
- Трубы и арматура должны быть установлены, промыты и проверены в соответствии с действующими нормами.
- Необходимо соблюдать требования по монтажу, действующие в соответствующих странах.
- Переключатель, используемый в смесителе ванной (тип НС), представляет из себя устройство, обеспечивающее защиту от отсоса. Поэтому нижний край переключателя должен быть расположен минимум 250 мм максимально возможным уровнем грязной воды.

Технические данные

Рабочее давление:	не более. 1 МПа
Рекомендуемое рабочее давление:	0,1 - 0,5 МПа
Давление:	1,6 МПа
(1 МПа = 10 bar = 147 PSI)	
Температура горячей воды:	не более. 80 °С
Рекомендуемая темп. гор. воды:	65 °С
Термическая дезинфекция:	не более. 70 °С / 4 мин

Неисправность	Причина	Устранение неисправности
недостаточный давление (если устан напор воды)	- Клапан обратного тока заедает	- Замените клапаны обратного течения
	- Фильтр душа загрязнен	- Очистить фильтр
Арматура работает с усилием	- Картридж неисправен, засорение накипью	- Замените картридж
Арматура протекает	- Картридж неисправен	- Замените картридж
Температура горячей воды слишком низкая	- Ограничение горячей воды отрегулировано неправильно	- Отрегулируйте ограничение горячей воды
Проточный нагреватель не включается	- Дроссель не удален из ручного душа	- Извлеките дроссель из ручного душа
	- Фильтр душа загрязнен	- Очистить фильтр
	- Клапан обратного тока заедает	- Замените клапаны обратного течения

укомплектован клапаном обратного тока воды
Изделие предназначено исключительно для питьевой воды!

Описание символов



Не применяйте силикон, содержащий уксусную кислоту.



Подгонка (см. стр. 33)

Регулировка ограничителя горячей воды. В сочетании с проточными нагревателями не рекомендуется использовать блокировку воды.



Техническое обслуживание (см. стр. 40)

Защита обратного тока должна регулярно проверяться (минимум один раз в год) по стандарту DIN EN 1717 или в соответствии с национальными или региональными нормативами

Размеры (см. стр. 34)



Схема потока (см. стр. 34)



Эксплуатация (см. стр. 38)



Комплект (см. стр. 36)



Очистка

см прилагаемая брошюра





Знак технического контроля (см. стр. 40)





Biztonsági utasítások

-  A szerelésnél a zúzódások és vágási sérülések elkerülése érdekében kesztyűt kell viselni.
-  A terméket csak fürdéshez, mosakodáshoz, és egészségügyi tisztálkodáshoz szabad használni.
-  A hidegvíz- és a melegvíz-csatlakozások közötti nagy nyomáskülönbséget kikell egyenlíteni!

Szerelési utasítások

- A szerelés előtt ellenőrizni kell, hogy a terméknek nincs-e szállítási sérülése. Beépítés után a szállítási- vagy felületi sérüléseket nem ismerik el.
- A vezetékeket és a csaptelepet az érvényes szabványoknak megfelelően kell felszerelni, öblíteni és ellenőrizni
- Az egyes országokban érvényes installációs irányelveket be kell tartani.
- A kádtöltő keverő csaptelepbe behelyezett átállító (HC típus) visszaszivás elleni biztosító berendezésként van kivitelezve. Ezért az átállító alsó peremének min. 250 mm-rel a lehetséges legmagasabb szennyvízszint fölött kell lennie.

Műszaki adatok

Üzemi nyomás:	max. 1 MPa
Ajánlott üzemi nyomás:	0,1 - 0,5 MPa
Nyomáspróba:	1,6 MPa
(1 MPa = 10 bar = 147 PSI)	
Forróvíz hőmérséklet:	max. 80 °C
Forróvíz javasolt hőmérséklete:	65 °C
Termikus fertőtlenítés:	max. 70 °C / 4 perc

Visszafolyás gátlóval

A terméket kizárólag ivóvízhez tervezték!

Szimbólumok leírása



Ne használjon ecetsavtartalmú szilikon!



Beállítás (lásd a oldalon 33)

A meleg víz korlátozás beállítása. Átfolyós vízmelegítőknél meleg víz korlátozó használat nem ajánlott.



Karbantartás (lásd a oldalon 40)

A visszafolyásgátlók működése a DIN EN 1717 szabványnak megfelelően, a nemzeti vagy területi rendelkezésekkel összhangban, évente egyszer ellenőrizendő!



Méretet (lásd a oldalon 34)



Átfolyási diagramm

(lásd a oldalon 34)



Használat (lásd a oldalon 38)



Tartozékok (lásd a oldalon 36)



Tisztítás

lásd a mellékelt brosúrát.



Vizsgajel (lásd a oldalon 40)



Hiba	Ok	Megoldás
Kevés víz	- A visszafolyásgátló beragadt. - A zuhany szűrőtömítése koszos	- A visszafolyásgátló kicserélése javasolt. - A zuhany és a cső közötti szűrőt ki kell tisztítani
Nehezen nyitható a csap.	- A kerámiabetét meghibásodott, elvörösödött.	- A kerámiabetétet ki kell cserélni.
Csőpög a csap.	- A kerámiabetét meghibásodott.	- A kerámiabetétet ki kell cserélni.
túl alacsony melegvíz hőmérséklet	- A melegvíz szabályozó rosszul van beállítva.	- A melegvíz szabályozót újra be kell állítani.
Az átfolyós vízmelegítő nem kapcsol be.	- Nincs kiszerve a zuhanyrózsából a vízmennyiség szabályozó. - A zuhany szűrőtömítése koszos - A visszafolyásgátló beragadt.	- El kell távolítani a vízmennyiség szabályozót. - A zuhany és a cső közötti szűrőt ki kell tisztítani - A visszafolyásgátló kicserélése javasolt.



Szerelés lásd a oldalon 31



Turvallisuushjeet

-  Asennuksessa on käytettävä käsineitä puristumien ja viiltojen aiheuttamien tapaturmien estämiseksi.
-  Suihkujärjestelmää saa käyttää ainoastaan kylpy-, hygienia- ja puhdistustarkoituksiin.
-  Suuret paine-erot kylmä- ja kuumavesiliitäntöjen välillä on tasattava.

Asennusohjeet

- Ennen asennusta on tarkastettava tuotteen mahdolliset kuljetusvahingot. Asennuksen jälkeen kuljetus- ja pintavaurioita ei hyväksytä.
- Putket ja hana on asennettava, huuhdeltava ja tarkastettava voimassa olevien standardien mukaisesti.
- Jokaisessa maassa on noudatettava siellä päteviä asennusohjeita.
- Kylpyammeen sekoittimessa käytetty säädin (tyyppi HC) on malliltaan sellainen, että se suojaa takaisinimulta. Sen vuoksi säätimen alareunan täytyy olla vähintään 250 mm likaveden korkeimman mahdollisen tason yläpuolella.

Tekniset tiedot

Käyttöpaine:	maks. 1 MPa
Suosittelut käyttöpaine:	0,1 - 0,5 MPa
Koestuspaine:	1,6 MPa
(1 MPa = 10 bar = 147 PSI)	
Kuuman veden lämpötila:	maks. 80 °C
Kuuman veden suosituslämpötila:	65 °C
Lämpödesinfektio:	maks. 70 °C / 4 min

Estää itsestään paluuvirtauksen

Tuote on suunniteltu käytettäväksi ainoastaan juomaveden kanssa!

Merkin kuvaus



Älä käytä etikkahappopitoista silikonial



Säätö (katso sivu 33)

Lämpötilan rajoittimen säätäminen. Emme suosittele käyttämään lämpötilan rajoitinta vedenlämmittimen (läpivirtauskuumennin) yhteydessä.



Huolto (katso sivu 40)

Vastaventtiilin toiminta on tarkastettava säännöllisesti paikallisten ja kansallisten määräysten mukaisesti (DIN 1988, kerran vuodessa).



Mitat (katso sivu 34)



Virtausdiagrammi

(katso sivu 34)



Käyttö (katso sivu 38)



Varaosat (katso sivu 36)



Puhdistus

katso oheinen esite



Koestusmerkki (katso sivu 40)

Häiriö	Syy	Toimenpide
Vähän vettä	- Suuntaisventtiili juuttunut - Käsिसuihkun sihtitiiviste likaantunut	- Vaihda suuntaisventtiili - Puhdista suihkukahvan ja letkun välissä oleva sihtitiiviste
Hana on raskaskäyttöinen	- Patruuna rikki, kalkkikerrostumia	- Vaihda patruuna
Hanasta tippuu vettä	- Patruuna rikki	- Vaihda patruuna
Lämminveden lämpötila liian alhainen	- Lämminveden rajoitin väärin säädetty	- Säädä lämminveden rajoitin
Läpimenokuumennin ei kytkeydy päälle	- Käsिसuihkussa olevaa kuristinta ei ole poistettu - Käsिसuihkun sihtitiiviste likaantunut	- Poista kuristin käsिसuihkusta - Puhdista suihkukahvan ja letkun välissä oleva sihtitiiviste
	- Suuntaisventtiili juuttunut	- Vaihda suuntaisventtiili





! Säkerhetsanvisningar

- △ Handskar ska bäras under monteringsarbetet så att man kan undvika kläm- och skärskadorgen werden.
- △ Produkten får bara användas till kroppshygien med bad och dusch.
- △ Stora tryckskillnader mellan anslutningarna för varmt och kallt vatten måste utjämnas.

Monteringsanvisningar

- Det måste undersökas om produkten har transportskador innan den monteras. Efter monteringen accepteras inga transport- eller ytskiktsskador.
- Ledningarna och blandaren måste monteras, spolas igenom och kontrolleras enligt de gällande normerna.
- De installationsriktlinjer som gäller i länderna ska följas.
- Omkastaren (modell HC) som sitter i karblandaren är utformad som säkerhetsanordning mot baksug. Därför måste omkastarens underkant befinna sig min. 250 mm över den högsta möjliga smutsvattennivån.

Tekniska data

Driftstryck:	max. 1 MPa
Rek. driftstryck:	0,1 - 0,5 MPa
Tryck vid provtryckning:	1,6 MPa
(1 MPa = 10 bar = 147 PSI)	
Varmvattentemperatur:	max. 80 °C
Rek. varmvattentemp.:	65 °C
Termisk desinfektion:	max. 70 °C / 4 min

Självspärr mot återflöde
Produkten är enbart avsedd för dricksvatten!

Symbolförklaring



Använd inte silikon som innehåller ättiksyra!



Justering (se sidan 33)

Ställa in varmvattenregleringen. Tillsammans med varmvattenberedare rekommenderas inte en varmvattenspärr.



Skötsel (se sidan 40)

Backventilers funktion måste kontrolleras regelbundet enligt nationella eller regionala bestämmelser (DIN 1988 en gång per år) i enlighet med DIN EN 1717.



Måtten (se sidan 34)



Flödesschema

(se sidan 34)



Hantering (se sidan 38)



Reservdelar (se sidan 36)



Rengöring

se den medföljande broschyren



Testsigill (se sidan 40)

Störning	Orsak	Åtgärd
För lite vatten	- Backventil är defekt - Silfiltret i duschen smutsigt	- Byt backventil - Rengör silfiltret mellan slangen och termostaten
Blandare är trög	- Patron defekt, förkalkad	- Byt ut patron
Blandare droppar	- Patron defekt	- Byt ut patron
Varmvattentemperaturen är för låg	- Varmvattenreglering felaktigt inställd	- Ställ in varmvattenreglering
Varmvattenberedare slår ej på	- Vattenbegränsare i handduschen har ej tagits bort - Silfiltret i duschen smutsigt	- Ta bort vattenbegränsaren - Rengör silfiltret mellan slangen och termostaten
	- Backventil är defekt	- Byt backventil





⚠ Saugumo technikos nurodymai

- ⚠ Apsauga nuo užspaudimo ir įsijovimo montavimo metu mūvėkite pirštines.
- ⚠ Gaminys turi būti naudojamas tik maudymuisi, kūno higienai ir švarai palaikyti.
- ⚠ Turi būti išlyginti šalto ir karšto slėgio nelygumai.

Montavimo instrukcija

- Prieš montuojant būtina patikrinti, ar gaminys nebuvo pažeistas transportavimo metu. Sumontavus pretenzijos dėl transportavimo ir paviršiaus pažeidimų nepriimamos.
- Vamzdžiai ir sujungimai turi būti montuojami, plaunami ir tikrinami pagal galiojančias normas.
- Laikytės atitinkamoje šalyje galiojančių direktyvų dėl įrengimo.
- Vonios maišytuve esantis perjungiklis (HC tipo) veikia kaip apsauga nuo atgalinio siurbimo. Todėl perjungiklio apatinis kraštas tyru būti bent 250 mm virš aukščiausio galimo nešvaraus vandens pakilimo taško.

Techniniai duomenys

Darbinis slėgis: ne daugiau kaip 1 MPa
 Rekomenduojamas slėgis: 0,1 - 0,5 MPa
 Bandomasis slėgis: 1,6 MPa
 (1 MPa = 10 barų = 147 PSI)
 Karšto vandens temperatūra: ne daugiau kaip 80 °C
 Rekomenduojama karšto vandens temperatūra: 65 °C
 Terminis dezinfekavimas: ne daugiau kaip 70 °C / 4 min

Su atbuliniu vožtuvu
 Produktas skirtas tik geriamajam vandeniui!

Simbolio aprašymas



Nenaudokite silikono, kurio sudėtyje yra acto rūgšties!



Reguliavimas (žr. psl. 33)

Karšto vandens ribojimas. Kartu su cirkuliaciniais šildytuvais nerekomenduojama naudoti karšto vandens blokavimo įtaisų.



Techninis aptarnavimas (žr. psl. 40)

Atbulinio vožtuvo apsauga privalo būti tikrinama reguliariai (mažiausiai kartą per metus pagal DIN 1988) pagal DIN EN1717 arba pagal galiojančias nacionalines arba regionines normas.

Išmatavimai (žr. psl. 34)



Pralaidumo diagrama

(žr. psl. 34)



Eksplotacija (žr. psl. 38)



Atsarginės dalys (žr. psl. 36)



Valymas

žr. priedamoje brošiūroje.

Bandymo pažyma (žr. psl. 40)





Gedimas	Priežastis	Priemonė
Per maža srovė	- Abulinis vožtuvas neveikia - Dušo galvos filtras užsikimšęs	- Pakeisti atbulinį vožtuvą - Išvalyti dušo galvos filtrą
Sunkiai sukiojama rankenėlė	- Kasetė pažeista, užkalkėjusi	- Pakeisti kasetę
Maišytuvas praleidžia vandenį	- Kasetė pažeista	- Pakeisti kasetę
Per maža karšto vandens temperatūra	- Neteisingai nustatytas karšto vandens ribotuvas	- Nustatyti karšto vandens ribotuvą
Momentinis pašildytojas neįsijungia	- Neišimtas ribotuvas iš dušo galvutės - Dušo galvos filtras užsikimšęs - Abulinis vožtuvas neveikia	- Išimti ribotuvą iš dušo galvutės - Išvalyti dušo galvos filtrą - Pakeisti atbulinį vožtuvą





Sigurnosne upute

-  Prilikom montaže se radi sprječavanja prignječenja i posjekotina moraju nositi rukavice.
-  Proizvod se smije primjenjivati samo za kupanje, tuširanje i osobnu higijenu.
-  Velika razlika u pritisku između vruće i hladne vode mora biti izbalansirana.

Upute za montažu

- Prije montaže mora se provjeriti je li proizvod oštećen prilikom transporta. Nakon ugradnje se ne priznaju nikakve reklamacije koje se odnose na površinska i transportna oštećenja.
- Cijevi i armatura moraju biti postavljeni, isprani i testirani prema važećim normama.
- Obvezno se moraju uvažiti propisi o instalacijama koji vrijede u dotičnoj zemlji.
- Selektor (tip HC) ugrađen u miješalici za kadu konstruiran je kao element zaštite od povratnog usisavanja. Zato se donji rub selektora mora nalaziti najmanje 250 mm iznad najviše moguće razine prljave vode.

Tehnički podaci

Najveći dopušteni tlak:	tlak 1 MPa
Preporučeni tlak:	0,1 - 0,5 MPa
Probni tlak:	1,6 MPa
(1 MPa = 10 bar = 147 PSI)	
Temperatura vruće vode:	tlak 80 °C
Preporučena temperatura vruće vode:	65 °C
Termička dezinfekcija:	tlak 70 °C / 4 min

Funkcije samo-čišćenja

Proizvod je koncipiran isključivo za pitku vodu!

Opis simbola



Nemojte koristiti silikon koji sadrži octenu kiselinu!



Regulacija (pogledaj stranicu 33)

Namještanje limitera tople vode. U kombinaciji s protočnim bojlerima nije preporučljiva primjena sustava za blokiranje dotoka tople vode.



Održavanje (pogledaj stranicu 40)

Ispravnost nepovratnog ventila mora se redovito provjeravati prema standardu DIN EN 1717 i u skladu sa važećim propisima (najmanje jednom godišnje).



Mjere (pogledaj stranicu 34)



Dijagram protoka

(pogledaj stranicu 34)



Upotreba (pogledaj stranicu 38)



Rezervni dijelovi (pogledaj stranicu 36)



Čišćenje

se u priloženoj brošuri.



Oznaka testiranja (pogledaj stranicu 40)

Greška	Uzrok	Otklanjanje
Nedovoljno vode	- Nepovratni ventil se nije vratio u početni položaj - Filter tuša je prljav	- Zamijenite nepovratni ventil - Očistite filter između tuša i crijeva
Ručica se zaglavila	- Neispravan uložak Taloženje kalcijemena	- Zamijenite uložak
Slavina kaplje	- Neispravan uložak	- Zamijenite uložak
Preiska temperatura tople vode	- Limiter vruće vode nije dobro podešen	- Podesite limiter vruće vode
Protočni bojler ne radi	- Limiter protoka u ručnom tušu nije odstranjen - Filter tuša je prljav - Nepovratni ventil se nije vratio u početni položaj	- Odstranite limiter protoka - Očistite filter između tuša i crijeva - Zamijenite nepovratni ventil



Sastavljanje pogledaj stranicu 31



⚠ Güvenlik uyarıları

- ⚠ Montaj esnasında ezilme ve kesilme gibi yaralanmaları önlemek için eldiven kullanılmalıdır.
- ⚠ Duş sistemi yalnızca banyo, hijyen ve beden temizliği amaçları doğrultusunda kullanılabilir.
- ⚠ Sıcak ve soğuk su bağlantıları arasında büyük basınç farklılıkları varsa, bu basınç farklılıklarının dengelenmesi gerekir.

Montaj açıklamaları

- Montaj işleminden önce ürün nakliye hasarları yönünden kontrol edilmelidir. Montaj işleminden sonra nakliye veya yüzey hasarları için sorumluluk üstlenilmemektedir.
- Boruların ve armatürün montajı, yıkanması ve kontrolü geçerli normlara göre yapılmalıdır.
- Ülkelerde geçerli kurulum yönetmeliklerine riayet edilmelidir.
- Tekne karıştırıcısına yerleştirilmiş değiştirici (tip HC), geri emişe karşı sigorta tertibatı olarak tasarlanmıştır. Bu nedenle değiştiricinin alt kenarı, mümkün olan en yüksek kirli su seviyesinin en az 250 mm üstünde olmalıdır.

Teknik bilgiler

İşletme basıncı:	azami 1 MPa
Tavsiye edilen işletme basıncı:	0,1 - 0,5 MPa
Kontrol basıncı:	1,6 MPa
(1 MPa = 10 bar = 147 PSI)	
Sıcak su sıcaklığı:	azami 80°C
Tavsiye edilen su ısısı:	65°C
Termik dezenfeksiyon:	azami 70°C / 4 dak

Geri emme önleyici
Ürün sadece şebeke suyu için tasarlanmıştır!

Simge açıklaması



Asetik asit içeren silikon kullanmayın!



Ayarlama (bakınız sayfa 33)

Sıcak su sınırlamasının ayarlanması. Sıcak su kilidinin sürekli ısıtıcıyla kullanılması tavsiye edilmez.



Bakım (bakınız sayfa 40)

DIN EN 1717 ve ulusal standartlar doğrultusunda Çek valfler düzenli olarak kontrol edilmelidir. (en az yılda bir kez)



Ölçüleri (bakınız sayfa 34)



Akış diyagramı (bakınız sayfa 34)



Kullanımı (bakınız sayfa 38)



Yedek Parçalar (bakınız sayfa 36)



Temizleme

birlikte verilen broşür





Kontrol işareti (bakınız sayfa 40)

arıza	sebebi	yardım
Az su geliyor	- Çek valf çalışmıyor olabilir - Duşun süzgeci tıkanmış olabilir	- Çek valfi değiştirin - El duşu ile hortum arasındaki hortumu yıkayın
Batarya kullanımı ağırlaşıyor	- Kartuş Bozulmuş ve kireçlenmiş olabilir	- Kartuşu değiştirin
Batarya su damlatıyor	- Kartuş bozuk olabilir	- Kartuşu değiştirin
Sıcak suyun derecesi çok düşük	- Isı limitleyici düzgün çalışmıyor	- Isı limitleyiciyi yeniden ayarlayın
Şofben çalışmıyor	- El duşunun içindeki akım limitleyici çıkartılmamış olabilir - Duşun süzgeci tıkanmış olabilir	- Akım limitleyiciyi el duşundan çıkartın - El duşu ile hortum arasındaki hortumu yıkayın
	- Çek valf çalışmıyor olabilir	- Çek valfi değiştirin





Instrucțiuni de siguranță

-  La montare utilizați mănuși pentru evitarea contuziunilor și tăierii mâinilor.
-  Sistemul de duș poate fi utilizat doar pentru spălarea, menținerea igienei și curățarea corpului.
-  Diferențele de presiune mari între alimentarea cu apă rece și apă caldă trebuie echilibrate.

Instrucțiuni de montare

- Înainte de instalare verificați, dacă produsul prezintă deteriorări de transport. După instalare garanția nu acoperă deteriorările de transport și cele de suprafață.
- Conductele și bateriile trebuie montate, spălate și verificate conform normelor în vigoare.
- Respectați reglementările referitoare la instalare valabile în țara respectivă.
- Comutatorul introdus la robinetul de amestecare pentru cadă (de tip HC) este prevăzut cu un dispozitiv de siguranță contra reaspirării. Astfel marginea inferioară a comutatorului trebuie să se afle la min. 250 mm deasupra nivelului cel mai înalt posibil de apă uzată.

Date tehnice

Presiune de funcționare:	max. 1 MPa
Presiune de funcționare recomandată:	0,1 - 0,5 MPa
Presiune de verificare:	1,6 MPa
(1 MPa = 10 bar = 147 PSI)	
Temperatura apei calde:	max. 80 °C
Temperatura recomandată a apei calde:	65 °C
Dezinfecție termică:	max. 70 °C / 4 min

Asigurat contra scurgere înapoi
Produsul este destinat exclusiv pentru apă potabilă.

Descrierea simbolurilor



Nu utilizați silicon cu conținut de acid acetic!



Reglare (vezi pag. 33)

Reglarea limitatorului de apă caldă. Nu se recomandă folosirea unui limitator de apă caldă în combinație cu un boiler instant.



Întreținere (vezi pag. 40)

Supapele de reținere trebuie verificate regulat conform DIN EN 1717 și standardele naționale sau regionale (anual conform DIN 1988).



Dimensiuni (vezi pag. 34)



Diagrama de debit

(vezi pag. 34)



Utilizare (vezi pag. 38)



Piese de schimb (vezi pag. 36)



Curățare

vezi broșura alăturată.



Certificat de testare (vezi pag. 40)

Deranjament	Cauza	Măsuri de remediere
Prea puțină apă	- S-a blocat supapa antiretur. - S-a murdărit garnitura de sită a capătului de duș.	- Schimbați supapa antiretur. - Curățați garnitura sită dintre capătul duș și furtun.
Bateria se mișcă dificil	- Cartuș defect din cauza depunerilor de calcar	- Schimbați cartușul.
Bateria picură	- Cartuș defect	- Schimbați cartușul.
Temperatura apei calde este prea mică	- Limitarea temperaturii apei calde setată incorect.	- Setăți limitarea temperaturii apei calde.
Boilerul instant nu funcționează.	- Reductorul nu a fost demontat din dușul de mână. - S-a murdărit garnitura de sită a capătului de duș. - S-a blocat supapa antiretur.	- Îndepărtați reductorul din dușul de mână. - Curățați garnitura sită dintre capătul duș și furtun. - Schimbați supapa antiretur.



Montare vezi pag. 31



⚠ Υποδειξεις ασφαλείας

- ⚠ Για να αποφύγετε τραυματισμούς κατά τη συναρμολόγηση πρέπει να φοράτε γάντια.
- ⚠ Το προϊόν επιτρέπεται να χρησιμοποιείται μόνο σαν μέσο λουτρού, υγιεινής και καθαρισμού του σώματος.
- ⚠ Οι διαφορές της πίεσης μεταξύ της σύνδεσης κρύου και ζεστού νερού θα πρέπει να αντισταθμίζονται.

Οδηγίες συναρμολόγησης

- Πριν τη συναρμολόγηση πρέπει να εξεταστεί το προϊόν για ζημιές μεταφοράς. Μετά την εγκατάσταση δεν αναγνωρίζονται ζημιές από τη μεταφορά ή επιφανειακές ζημιές.
- Οι σωλήνες και η μπαταρία πρέπει να τοποθετηθούν σύμφωνα με τα ισχύοντα πρότυπα, να τεθούν υπό πίεση και να δοκιμαστούν.
- Θα πρέπει να τηρούνται οι οδηγίες εγκατάστασης που ισχύουν σε κάθε κράτος.
- Ο διακόπτης επιλογής στην αναμικτική μπαταρία (τύπος HC) είναι σχεδιασμένος έτσι, ώστε να αποκλείεται η απορρόφηση. Για τον λόγο αυτόν πρέπει η κάτω ακμή του διακόπτη επιλογής να βρίσκεται τουλάχιστον 250 mm πάνω από την ανώτατη στάθμη των ακάθαρτων νερών της μπανιέρας.

Τεχνικά Χαρακτηριστικά

Λειτουργία πίεσης:	έως 1 MPa
Συνιστώμενη λειτουργία πίεσης:	0,1 - 0,5 MPa
Πίεση ελέγχου:	1,6 MPa
(1 MPa = 10 bar = 147 PSI)	
Θερμοκρασία ζεστού νερού:	έως 80 °C
Συνιστώμενη θερμοκρασία ζεστού νερού:	65 °C
Θερμική απολύμανση:	έως 70 °C / 4 min

Περιλαμβάνει βαλβίδα αντεπιστροφής.
Το προϊόν έχει σχεδιαστεί αποκλειστικά για πόσιμο νερό!

Περιγραφή συμβόλων



Μην χρησιμοποιείτε σιλικόνη που περιέχει οξικό οξύ!



Ρύθμιση (βλ. Σελίδα 33)

Ρύθμιση του δοσομετρητή ζεστού νερού. Δεν συνιστάται η διάταξη φραγής ζεστού νερού σε συνδυασμό με ταχυθερμοσίφωνα.



Συντήρηση (βλ. Σελίδα 40)

Οι βαλβίδες αντεπιστροφής πρέπει να ελέγχονται τακτικά ως προς τη λειτουργία τους, σύμφωνα με τις οδηγίες DIN EN 1717, σε σχέση με τους ισχύοντες εθνικούς ή τοπικούς κανόνες (το ελάχιστο μια φορά το χρόνο, σύμφωνα με το πρότυπο DIN 1988)



Διαστάσεις (βλ. Σελίδα 34)



Διάγραμμα ροής

(βλ. Σελίδα 34)



Χειρισμός (βλ. Σελίδα 38)



Ανταλλακτικά (βλ. Σελίδα 36)



Καθαρισμός

βλ. συνημμένο φυλλάδιο



Σήμα ελέγχου (βλ. Σελίδα 40)

Βλάβη

Ανεπαρκές νερό

Αιτία

- Η βαλβίδα αντεπιστροφής δεν γυρίζει πίσω.
- Βρώμικη στεγανοποιητική σήτα του καταιονιστήρα

Διόρθωση

- Αλλάξτε τη βαλβίδα αντεπιστροφής
- Καθαρίστε και, εάν χρειαστεί, αλλάξτε τη στεγανοποιητική σήτα μεταξύ καταιονιστήρα και σπινάλ

Σκληρή μπαταρία (μείκτης)

- Ελαττωματικό φυσίγγιο, άλατα

- Αλλαγή φυσιγγίου

Η μπαταρία στάζει

- Ελαττωματικό φυσίγγιο

- Αλλαγή φυσιγγίου

Χαμηλή θερμοκρασία ζεστού νερού

- Λάθος ρύθμιση της περιοριστικής διάταξης ζεστού νερού

- Ρυθμίστε την περιοριστική διάταξη του ζεστού νερού

Ο ταχυθερμοσίφωνα δεν ενεργοποιείται

- Το στραγγαλιστικό πηνίο δεν έχει αποσυρμολογηθεί από τον καταιονιστήρα χειρός
- Βρώμικη στεγανοποιητική σήτα του καταιονιστήρα

- Καθαρίστε το στραγγαλιστικό πηνίο από τον καταιονιστήρα χειρός



- Η βαλβίδα αντεπιστροφής δεν γυρίζει πίσω.

- Καθαρίστε και, εάν χρειαστεί, αλλάξτε τη στεγανοποιητική σήτα μεταξύ καταιονιστήρα και σπινάλ
- Αλλάξτε τη βαλβίδα αντεπιστροφής





Varnostna opozorila

-  Pri montaži je treba nositi rokavice, da se prepreči poškodbe zaradi zmečkanja ali urezov.
-  Ta izdelek se sme uporabljati le z namenom umivanja, vzdrževanja higiene in telesne nege.
-  Velike razlike v tlaku med priključkom za mrzlo in priključkom za toplo vodo je potrebno izravnati.

Navodila za montažo

- Pred montažo je treba izdelek preveriti glede morebitnih transportnih poškodb. Po vgradnji transportne ali površinske poškodbe ne bodo več priznane.
- Cevi in armaturo je treba montirati, izprati in preveriti po veljavnih standardih.
- Upoštevati je treba pravilnike o inštalacijah, ki veljajo v posamezni državi.
- V mešalno armaturo za kad vgrajen preklopnik (tip HC) je izveden kot mehanizem za zaščito pred povratnim sesanjem. Zato se mora spodnji rob preklopnika nahajati min. 250 mm nad najvišjim možnim nivojem umazane vode.

Tehnični podatki

Delovni tlak:	maks. 1 MPa
Priporočeni delovni tlak:	0,1 - 0,5 MPa
Preskusni tlak:	1,6 MPa
(1 MPa = 10 bar = 147 PSI)	
Temperatura tople vode:	maks. 80 °C
Priporočena temperatura tople vode:	65 °C
Termična dezinfekcija:	maks. 70 °C / 4 min

Zaščita proti povratnemu toku

Proizvod je zasnovan izključno za sanitarno vodo!

Opis simbola



Ne smete uporabiti silikona, ki vsebuje ocetno kislino!



Justiranje (glejte stran 33)

Nastavitev omejevalnika tople vode. V povezavi s pretočnimi grelniki uporaba zapore tople vode ni priporočljiva.



Vzdrževanje (glejte stran 40)

Delovanje protipovratnega ventila je potrebno v skladu z DIN EN 1717 in skladno z državnimi in regionalnimi določili (DIN 1988 enkrat letno) redno testirati.



Mere (glejte stran 34)



Diagram pretoka (glejte stran 34)



Upravljanje (glejte stran 38)



Rezervni deli (glejte stran 36)



Čiščenje

glejte priloženi brošuri.



Preskusni znak (glejte stran 40)

Napaka	Vzrok	Pomoč
Malo vode	- Protipovratni ventil je obtičal - Filtrirna mrežica prhe je umazana	- Zamenjajte protipovratni ventil - Očistite filtrirno mrežico med prho in gibko cevjo
Težko premikanje armature	- Pokvarjen vložek, poapneno	- Zamenjajte vložek
Iz armature kaplja	- Pokvarjen vložek	- Zamenjajte vložek
Prenizka temperatura tople vode	- Omejevalnik tople vode ni pravilno nastavljen	- Nastavite omejevalnik tople vode
Pretočni grelnik se ne vklopi	- Omejevalnik pretoka ni odstranjen iz ročne prhe - Filtrirna mrežica prhe je umazana	- Odstranite omejevalnik pretoka iz ročne prhe - Očistite filtrirno mrežico med prho in gibko cevjo
	- Protipovratni ventil je obtičal	- Zamenjajte protipovratni ventil



Montaža glejte stran 31



⚠️ Ohutusjuhised

- ⚠️ Kandke paigaldamisel muljumis- ja löikevigastuste vältimiseks kindaid.
- ⚠️ Toodet tohib kasutada ainult pesemis-, hügieeni- ja kehahapustamisesmärkidel.
- ⚠️ Kui külma ja kuuma vee ühenduste surve on väga erinev, tuleb need tasakaalustada.

Paigaldamisjuhised

- Enne paigaldamist tuleb toodet kontrollida transpordikahjustuste osas. Pärast paigaldamist ei tunnustata enam transpordi- või pinnakahjustuste kaebuseid.
- Voolikute ja segisti paigaldamisel, loputamisel ja kontrollimisel tuleb lähtuda kehtivatest normatiividest.
- Vastavas riigis kehtivaid paigalduseeskirju tuleb järgida.
- Vannisegistisse paigutatud pöördventiil (tüüp HC) kujutab endast seadist kaitseks tagasivoolu vastu. Seetõttu peab pöördventiili alaserv olema musta vee maksimaalselt võimalikust tasemest min. 250 mm kõrgemal.

Tehnilised andmed

Töörõhk	maks. 1 MPa
Soovitatav töörõhk:	0,1 - 0,5 MPa
Kontrollsurve:	1,6 MPa
(1 MPa = 10 baari = 147 PSI)	
Kuuma vee temperatuur:	maks. 80 °C
Soovitatav kuuma vee temperatuur:	65 °C
Termiline desinfitatsioon:	maks. 70 °C / 4 min

Tagasivooluklapp

Toode on ette nähtud eranditult joogivee jaoks!

Sümbolite kirjeldus



Ärge kasutage äädikhapet sisaldavat silikooni!



Reguleerimine (vt lk 33)

Sooja vee piirangu seadistamine. Ühenduses boileritega ei ole sooja vee blokeeringu soovitatav.



Hoolitus (vt lk 40)

Tagasilöögiklappide toimimist tuleb kooskõlas riiklike ja regionaalsete määrustega regulaarselt kontrollida vastavalt standardile DIN EN 1717 (DIN 1988 - kord aastas).



Mõõtude (vt lk 34)



Läbivooludiagramm

(vt lk 34)



Kasutamine (vt lk 38)



Varuosad (vt lk 36)



Puhastamine

vt kaasasolevast brošüürist.



Kontrollsertifikaat (vt lk 40)



Rike	Põhjus	Lahendus
Vähe vett	- Tagasilöögiklapp on kinni - Duši sõeltihend must	- Tagasilöögiklapp välja vahetada - Puhastage duši ja vooliku vaheline sõeltihend
Segisti käib raskelt	- Tööelement on katkine, lubjastunud	- Vahetage tööelement
Segisti tilgub	- Tööelement on katkine	- Vahetage tööelement
Sooja vee temperatuur liiga madal	- Kuuma vee piirang valesti seatud	- Seadke kuuma vee piirang
avatud süsteemi boiler ei lülitu sisse	- Veehulga piirajat ei ole ära võetud - Duši sõeltihend must	- Eemaldage veehulga piiraja - Puhastage duši ja vooliku vaheline sõeltihend
	- Tagasilöögiklapp on kinni	- Tagasilöögiklapp välja vahetada



Paigaldamine vt lk 31



Drošības norādes

-  Montāžas laikā, lai izvairītos no spiedumiem un iegriezumiem, nepieciešams nēsāt cimdus.
-  Šo produktu drīkst izmantot tikai, lai mazgātos, higiēnai un ķermeņa tīrīšanai.
-  Jāizlīdzina spiediena atšķirības starp aukstā un karstā ūdens pievadiem.

Norādījumi montāžai

- Pirms montāžas nepieciešams pārbaudīt, vai produktam transportēšanas laikā nav radušies bojājumi. Pēc iebūvēšanas bojājumi, kas radušies transportēšanas laikā, vai virsmas bojājumi netiek atzīti.
- Cauruļvadi un armatūra ir jāuzstāda, jāizskalo un jāpārbauda saskaņā ar spēkā esošajiem standartiem.
- Jāievēro attiecīgās valstīs spēkā esošās montāžas prasības.
- Vannas maisītājā iebūvētais pārslēdzējs (tips HC) ir iekārta, kas nodrošina aizsardzību pret izsūkšanu. Tādēļ pārslēdzēja apakšējai malai jāatrodas min. 250 mm virs maksimāli iespējamā netīra ūdens līmenim.

Tehniskie dati

Darba spiediens:	maks. 1 MPa
Ieteicamais darba spiediens:	0,1 - 0,5 MPa
Pārbaudes spiediens:	1,6 MPa
(1 MPa = 10 bar = 147 PSI)	
Karstā ūdens temperatūra:	maks. 80 °C
Ieteicamā karstā ūdens temperatūra:	65 °C
Termiskā dezinfekcija :	maks. 70 °C / 4 min

Drošības vārsts

Izstrādājums ir paredzēts tikai dzeramajam ūdenim!

Simbolu nozīme



Neizmantojiet silikonu, kas satur etiķskābi!



Ieregulēšana (skat. lpp. 33)

Karsta ūdens ierobežotāja regulēšana. Kopā ar caurteces sildītājiem nav ieteicams izmantot ūdens bloķētāju.



Apkope (skat. lpp. 40)

Regulāri jāpārbauda pretvārsta funkcija saskaņā ar DIN EN 1717 saistībā ar nacionālajiem vai vietējiem noteikumiem (DIN 1988 vienreiz gadā).



Izmērus (skat. lpp. 34)



Caurplūdes diagramma

(skat. lpp. 34)



Lietošana (skat. lpp. 38)



Rezerves daļas (skat. lpp. 36)



Tīrīšana

skatiet pievienotajā brošūrā.



Pārbaudes zīme (skat. lpp. 40)

Traucējums	Iemesls	Bojājumu novēršana
Maz ūdens	- Pretvārsts ir iesprūdis - Netīrs dušas filtra blīvējums	- Nomainīt pretvārstu - Izīrīt filtra blīvējumu starp dušu un šļūteni
Jaucējkrāns smagi grozāms	- Bojāta kartuša, aizkalķojusies	- Nomainīt kartušu
Jaucējkrāns pil	- Bojāta kartuša	- Nomainīt kartušu
Pārāk zema ūdens temperatūra	- Nepareizi noregulāta karstā ūdens bloķēšana	- Noregulēt karstā ūdens ierobežošanu
Neieslēdzas caurteces sildītājs	- Rokas dušā nav demontēts vārsts - Netīrs dušas filtra blīvējums	- Izņemt no rokas dušas vārstu - Izīrīt filtra blīvējumu starp dušu un šļūteni
	- Pretvārsts ir iesprūdis	- Nomainīt pretvārstu





! Sigurnosne napomene

- ⚠ Prilikom montaže se radi sprečavanja prignječenja i posekotina moraju nositi rukavice.
- ⚠ Proizvod sme da se koristi samo za kupanje, tuširanje i ličnu higijenu.
- ⚠ Velika razlika u pritisku između vruće i hladne vode mora biti izbalansirana.

Instrukcije za montažu

- Pre montaže se mora proveriti da li je proizvod oštećen pri transportu. Nakon ugradnje se ne priznaju nikakve reklamacije koje se odnose na površinska i transportna oštećenja.
- Vodovi i armatura moraju biti postavljeni, isprani i testirani prema važećim normama.
- Treba se pridržavati propisa koji u određenim zemljama važe za instalacije.
- Preusmerivač (tip HC) ugrađen u mešaču kade konstruisan je kao element zaštite od povratnog usisavanja. Iz tog razloga se donja ivica preusmerivača mora nalaziti najmanje 250 mm iznad najvišeg mogućeg nivoa prljave vode.

Tehnički podaci

Radni pritisak:	maks. 1 MPa
Preporučeni radni pritisak:	0,1 - 0,5 MPa
Probni pritisak:	1,6 MPa
(1 MPa = 10 bar = 147 PSI)	
Temperatura vruće vode:	maks. 80 °C
Preporučena temperatura vruće vode:	65 °C
Termička dezinfekcija:	maks. 70 °C / 4 min

Zaštita od povratnog toka
Proizvod je koncipiran isključivo za pijaću vodu!

Opis simbola



Nemojte koristiti silikon koji sadrži sircetnu kiselinu!



Podešavanje (vidi stranu 33)

Podešavanje ograničivača tople vode. U kombinaciji sa protočnim bojlerima ne preporučuje se primena sistema za blokiranje dotoka tople vode.



Održavanje (vidi stranu 40)

Ispravno funkcionisanje nepovratnog ventila se mora redovno proveravati prema standardu DIN EN 1717 i u skladu s važećim nacionalnim ili regionalnim propisima (DIN 1988 jednom godišnje).

Mere (vidi stranu 34)



Dijagram protoka

(vidi stranu 34)



Rukovanje (vidi stranu 38)



Rezervni delovi (vidi stranu 36)



Čišćenje

vidi priloženoj brošuri.



Ispitni znak (vidi stranu 40)





Smetnja	Uzrok	Pomoć
Nedovoljno vode	- Nepovratni ventil se nije vratio u početni položaj - Mrežasta zaptivka tuša je prljava	- Zamenite nepovratni ventil - Očistite mrežastu zaptivku između tuša i crijeva
Ručica se zaglavila	- Neispravna kartuša, nataloženi kamenac	- Zamenite kartušu
Slavina kaplje	- Neispravna kartuša	- Zamenite kartušu
Preiska temperatura tople vode	- Ograničavač vruće vode nije dobro podešen	- Podesite ograničavač vruće vode
Protočni bojler ne radi	- Prigušnica u ručnom tušu nije odstranjena - Mrežasta zaptivka tuša je prljava	- Odstranite prigušnicu iz ručnog tuša - Očistite mrežastu zaptivku između tuša i crijeva
	- Nepovratni ventil se nije vratio u početni položaj	- Zamenite nepovratni ventil



Montaža vidi stranu 31



Sikkerhetshenvisninger

-  Bruk hansker under montasjen for å unngå klem- og kuttskader.
-  Dusjsystemet skal kun brukes for bade-, hygiene- og kroppshygiene.
-  Store trykkdifferanser mellom kaldt- og varmtvannstilkoblinger skal utlignes.

Montagehenvisninger

- Før montasjen skal produktet sjekkes for transportskader. Etter monteringen aksepteres ikke noen transport- eller overflateskader.
- Ledningene og armaturen skal monteres, spyles og sjekkes iht. de gyldige normer.
- Gjeldende retningslinjer for rørleggerarbeid i de enkelte land skal følges.
- Omkobleren i badekarets blande batteri (type HC) er ment som en sikring mot retursug. Derfor skal underkanten av omkobleren være min. 250 mm over det høyest mulige nivået av skittent vann.

Tekniske data

Driftstrykk	maks. 1 MPa
Anbefalt driftstrykk:	0,1 - 0,5 MPa
Prøvetrykk	1,6 MPa
(1 MPa = 10 bar = 147 PSI)	
Varmtvannstemperatur	maks. 80 °C
Anbefalt temperatur for varmt vann	65 °C
Termisk desinfisering:	maks. 70 °C / 4 min

Egensikker mot tilbakeflyt
Produktet er utelukkende designet for drikkevann!

Symbolbeskrivelse



Ikke bruk silikon som inneholder eddiksyre!



Justering (se side 33)

Innstilling av varmtvannsbegrensning. I forbindelse med gjennomstrømningsvarmere er det ikke anbefalt å bruke en varmtvannssperre.



Vedlikehold (se side 40)

Funksjonen til returløpssperren skal iht. DIN EN 1717 og i samsvar med de nasjonale og lokale forskrifter sjekkes regelmessig (DIN 1988 en gang i året).



Mål (se side 34)



Gjennomstrømningsdiagram

(se side 34)



Betjening (se side 38)



Servicedeler (se side 36)



Rengjøring

se vedlagt brosjyre.



Prøvermerke (se side 40)



Feil	Årsak	Feilrettelse
Lite vann	- Returløpstopper sitter fast - Dusjens silpakning er skitten	- Returløpstopper byttes - Silpakning mellom dusj og slangen rengjøres
Armatur ikke lett bevegelig	- Kartusj defekt, forkalkning	- Kartusj byttes
Armatur drypper	- Kartusj defekt	- Kartusj byttes
For lav varmtvannstemperatur	- Varmtvannsbegrensning er feil innstilt	- Varmtvannsbegrensning innstilles
gjennomstrømningsvarmer innkobler ikke.	- Drossel til hånddusjen ikke fjernet - Dusjens silpakning er skitten	- Drossel fjernes fra hånddusjen - Silpakning mellom dusj og slangen rengjøres
	- Returløpstopper sitter fast	- Returløpstopper byttes



Montasje se side 31



Указания за безопасност

-  При монтажа трябва да се носят ръкавици, за да се избегнат наранявания поради притискане или порязване.
-  Позволено е използването на продукта само за къпане, хигиена и цели на почистване на тялото.
-  Големите разлики в налягането между изводите за студената и топлата вода трябва да се изравняват.

Указания за монтаж

- При монтажа продуктът трябва да се провери за транспортни щети. След монтажа не се признават транспортни или повърхностни щети.
- Тръбопроводите и арматурата трябва да се монтират, промият и проверят в съответствие с валидните норми.
- Трябва да бъдат спазвани валидните в съответните страни предписания за инсталиране.
- Използваният в смесителя за вана превключвател (тип HC) е изпълнен като приспособление за под-сигуряване против обратно засмукване. Поради това долният ръб на превключвателя трябва да се намира на мин. 250 мм над максимално високото ниво на мръсната вода.

Технически данни

Работно налягане:	макс. 1 МПа
Препоръчително работно налягане:	0,1 - 0,5 МПа
Контролно налягане:	1,6 МПа
(1 МПа = 10 bar = 147 PSI)	
Температура на горещата вода:	макс. 80 °C
Препоръчителна температура на горещата вода:	65 °C
Термична дезинфекция:	макс. 70 °C / 4 мин

Самозащитен против обратно изтичане
Продуктът е разработен само за питейна вода!

Описание на символите



Не използвайте силикон, съдържащ оцветна киселина!



Юстиране (вижте стр. 33)

Настройка на ограничителя за топлата вода. Във връзка с проточни нагреватели не се препоръчва блокировка за топлата вода



Поддръжка (вижте стр. 40)

Съгласно DIN EN 1717 редовно трябва да се проверява функционирането на приспособленията за предотвратяване на обратния поток в съответствие с националните или регионални изисквания (DIN 1988 веднъж годишно).

Размери (вижте стр. 34)



Диаграма на потока

(вижте стр. 34)



Обслужване (вижте стр. 38)



Сервизни части (вижте стр. 36)



Почистване

от приложената брошура.



Контролен знак (вижте стр. 40)





Неизправност	Причина	Помощ
Малко вода	- Здраво стоящо приспособление за предотвратяване на обратния поток - Замърсено е уплътнението с цедка на разпръсквателя	- Смяна на приспособлението за предотвратяване на обратния поток - Почистете уплътнението с цедка между разпръсквателя и маркуча
Трудно подвижна арматура	- Дефектна гилза, покрита с варовик	- Сменете гилзата
Арматурата капе	- Дефектна гилза	- Сменете гилзата
Твърде ниска температура на водата	- Ограничението за топлата вода е грушно настроено	- Настройте ограничението за топлата вода
Проточният нагревател не се включва	- Дроселът в ръчния разпръсквател не е демонтиран - Замърсено е уплътнението с цедка на разпръсквателя - Здраво стоящо приспособление за предотвратяване на обратния поток	- Отстранете дросела от ръчния разпръсквател - Почистете уплътнението с цедка между разпръсквателя и маркуча - Смяна на приспособлението за предотвратяване на обратния поток



Монтаж вижте стр. 31



Udhëzime sigurie

-  Për të evituar lëndimet e pickimeve ose të prerjeve gjatë procesit të montimit duhet që të vishni doreza.
-  Produkti duhet të përdoret vetëm qëllimet e banjave, të higjienës dhe të larjes së trupit.
-  Ndryshimet e mëdha të presionit mes lidhjeve të ujit të ftohtë dhe atij të ngrohtë duhen ekuilibruar.

Udhëzime për montimin

- Përpara montimit duhet që produkti të kontrollohet për dëmtime nga transporti. Pas instalimit nuk do të njihet asnjë dëmtim nga transporti ose dëmtim i sipërfaqes.
- Tubacionet dhe rubinetet duhet që të montohen, të shpëlahen dhe të kontrollohen sipas standardeve në fuqi
- Duhet të respektohen linjat udhëzuese të instalimit, të vlefshme për vendet respektive.
- Pajisja rregulluese e instaluar në përzijersin e vaskes (tip HC) është një pajisja për tu siguruar ndaj rithithjes së ujit. Prandaj pjesa e poshtme e pajisjes duhet të vendoset të paktën 250mm mbi nivelin më të lartë të sipërfaqes së ujit të ndotur.

Të dhëna teknike

Presioni gjatë punës	maks. 1 MPa
Presioni i rekomanduar:	0,1 - 0,5 MPa
Presioni për provë:	1,6 MPa
(1 MPa = 10 bar = 147 PSI)	
Temperatura e ujit të ngrohtë	maks. 80 °C
Temperatura e rekomanduar e ujit të ngrohtë:	65 °C
Dezinfektim Termik:	maks. 70 °C / 4 min

Siguresa kundër rrjedhjes në drejtim të kundërt
Produkti është projektuar ekskluzivisht për ujë të pijshëm!

Përshkrimi i simbolit



Mos përdorni silikon që në përbërje ka acid acetik.



Justimi (shih faqen 33)

Rregullimi i kufizimit me ujë të nxehtë. Një kombinim me një bojler ujit nuk është i rekomanduar.



Mirëmbajtja (shih faqen 40)

Penguesit e rrjedhjes në drejtim të kundërt duhen kontrolluar rregullisht në bazë të normave DIN EN 1717 konform normave nacionale dhe regionale (DIN 1988 një herë në vit).



Përmasat (shih faqen 34)



Diagrami i qarkullimit

(shih faqen 34)



Përdorimi (shih faqen 38)



Pjesët e servisit (shih faqen 36)



Pastrimi

shikoni broshurën bashkëngjitur.



Shenja e kontrollit (shih faqen 40)

Dëmtim	Shkaku	Ndihme
Pak ujë	- Penguesi i rrjedhjes mbrapsht te ujit qendron i fiksuar - Gomina hermetizuese e pajisjes me papasterti	- Kembeni pernguesin e rrjedhjes mbrapsht te ujit - Pastroni gominen e sites midis pajisjes dhe tubit
Armatura punon rende	- Kartusha me defekt, me kalk	- Kembeni kartushen
Armatura pikon	- Kartusha me defekt	- Kembeni kartushen
Temperaturë e ulët e ujit të ngrohtë	- Kufiri i ujit te ngrohte eshte regjistruar gabim	- Regjistroni kufirin e ujit te ngrohte
Ngrohesi i ujit nuk ndizet.	- Rregulluesi i ujit në tubacione nuk është i hequr nga spërkatësja	- Hiqni rregulluesin e ujit në tubacione nga spërkatësja
	- Gomina hermetizuese e pajisjes me papasterti	- Pastroni gominen e sites midis pajisjes dhe tubit
	- Penguesi i rrjedhjes mbrapsht te ujit qendron i fiksuar	- Kembeni pernguesin e rrjedhjes mbrapsht te ujit



Montimi shih faqen 31



خاصية عدم التدفق العكسي
المنتج مخصص فقط لماء الشرب!

وصف الرمز

هام! لا تستخدم السليكون الذي يحتوي على
أحماض!



الضبط (راجع صفحة 33)

ضبط تحديد المياه الدافئة. لا ينصح باستخدام
محدد المياه الدافئة مع سخان المياه الوتقي.



الصيانة (راجع صفحة 40)

يجب فحص صمام عدم الرجوع بصفة
منتظمة حسب المواصفة DIN EN 1717
وذلك طبقاً للوائح الوطنية أو الإقليمية (مرة
واحد سنوياً طبقاً للمواصفة DIN 1988).



أبعاد (راجع صفحة 34)

رسم للصراف (راجع صفحة 34)

التشغيل (راجع صفحة 38)

قطع الغيار (راجع صفحة 36)

التنظيف

راجع والكتيب المرفق

شهادة اختبار (راجع صفحة 40)



⚠ تنبيهات الأمان

⚠ يجب إرتداء قفازات لليد أثناء التركيب لتجنب
حدوث أخطار الإنحشار أو الجروح.

⚠ لا يجب استخدام نظام الدش إلا في أغراض
الاستحمام والأغراض الصحية وأغراض تنظيف
الجسم.

⚠ يجب أن يكون تيار الماء الساخن والماء البارد
متعادلين في الضغط.

تعليمات التركيب

- قبل القيام بعملية التركيب، يجب فحص المنتج للتأكد
من خلوه من أية تلفيات ناتجة عن النقل. بعد القيام
بعملية التركيب، لن يتم الاعتراف بوجود أية تلفيات
سطحية أو تلفيات ناتجة عن عملية النقل.
- يجب تركيب وغسيل واختبار التوصيلات وخلطات
المياه طبقاً للمعايير السارية.
- يجب مراعاة القواعد الخاصة بالتركيب وأعمال
السباكة وفقاً للوائح الخاصة بكل بلد.

• المحول من طراز (HC) المركب في خلاط البانيو
عبارة عن تجهيزة لضمان عدم الشفط المضاد. لذا يلزم
أن تكون المسافة بين الحد الأسفل للمحول وأعلى نقطة
لمستوى الماء المتسخ 250 مم بحد أدنى.

المواصفات الفنية

- ضغط التشغيل: الحد الأقصى 1 ميجاباسكال
- ضغط التشغيل الموصى به: 0,5 - 0,1 ميجاباسكال
- ضغط الاختبار: 1,6 ميجاباسكال
- (1 ميجاباسكال = 10 بار = 147 PSI)
- درجة حرارة الماء الساخن: الحد الأقصى 80°C
- درجة الحرارة الموصى بها للماء الساخن: 65°C
- تقييم حراري: الحد الأقصى 4 / 70°C الدقيقة

العطل	السبب	العلاج والإصلاح
الماء غير كاف	- صمام منع الرجوع ثابت ولا يتحرك	- قم بتغيير صمام منع الرجوع
	- سداة مصفاة الدش متسخة	- نظف سداة المصفاة بين الدش والخرطوم
الخلاط ثقيل الحركة	- الخرطوشة نالفة، تراكم عليها الجير	- قم بتغيير الخرطوشة
تساقط قطرات مياه من الخلاط	- الخرطوشة نالفة	- قم بتغيير الخرطوشة
درجة حرارة الماء الساخن منخفضة للاغاية	- محدد الماء الساخن مضبوط بشكل خاطيء	- قم بضبط محدد الماء الساخن
السخان الفوري لا يعمل	- محدد التدفق غير مخلوع من الدش	- انزع محدد التدفق من الدش
	- سداة مصفاة الدش متسخة	- نظف سداة المصفاة بين الدش والخرطوم

- صمام منع الرجوع ثابت ولا يتحرك - قم بتغيير صمام منع الرجوع

التركيب راجع صفحة 31



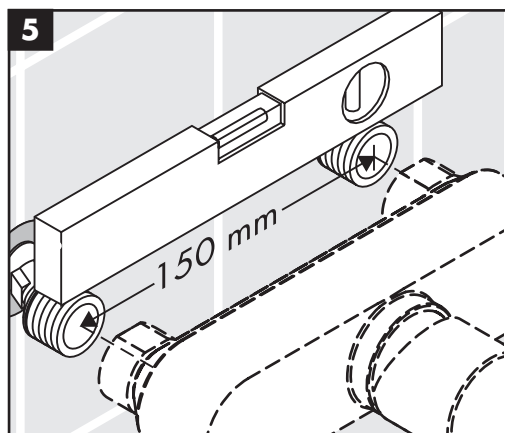
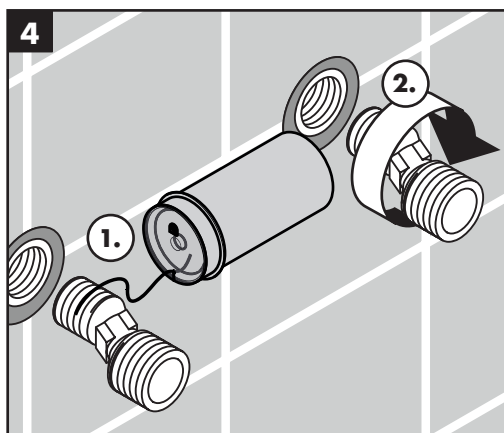
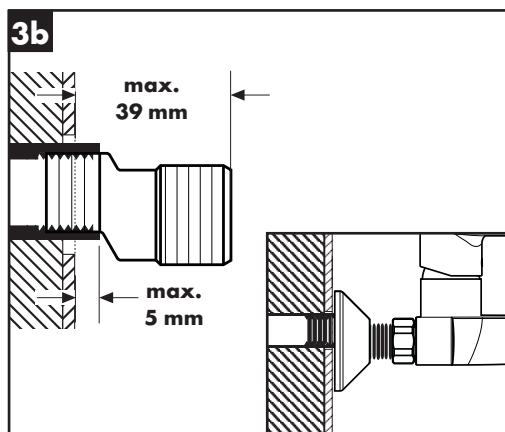
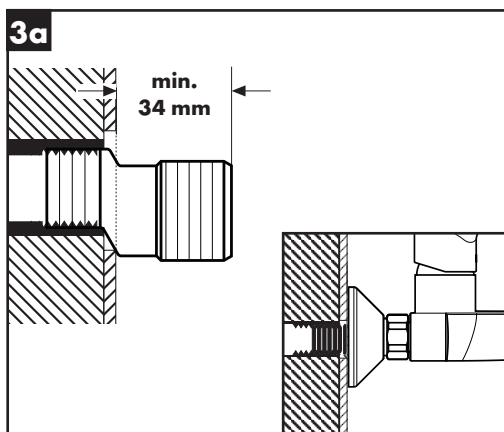
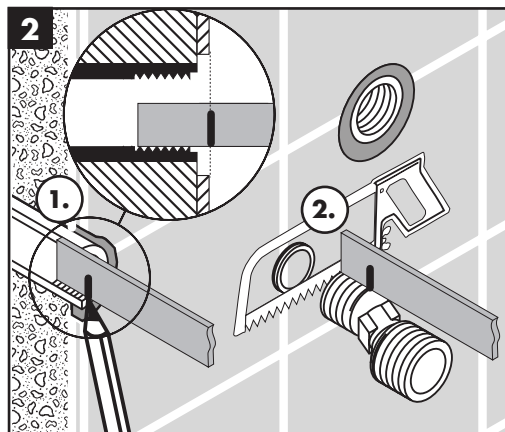
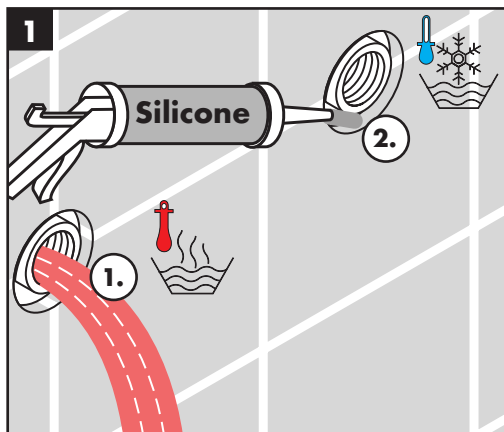

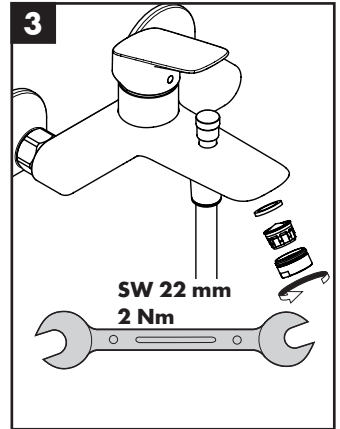
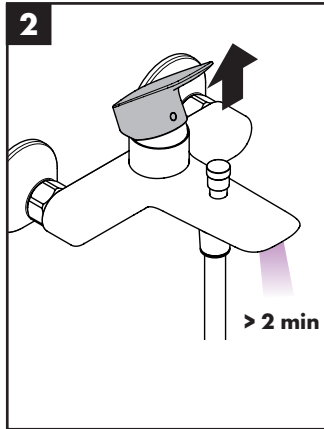
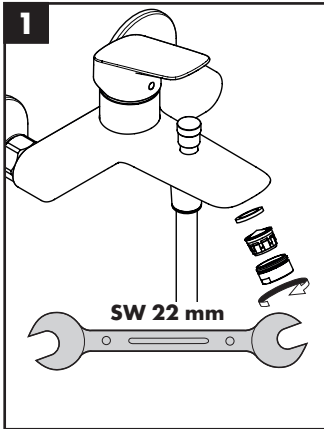
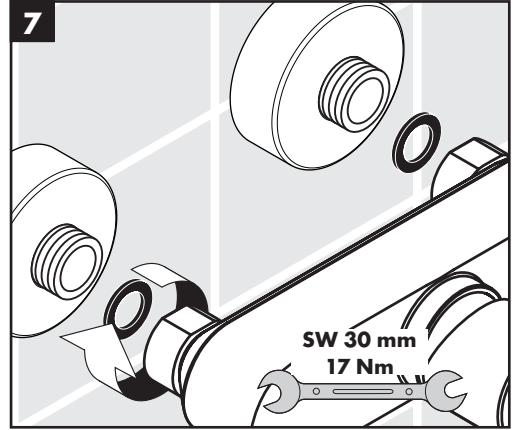
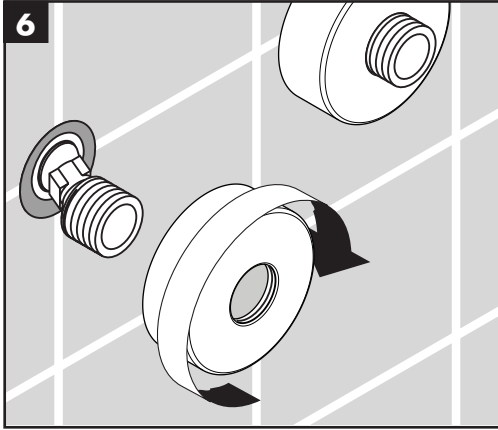



60 °C



10 °C



0,3 MPa
0,3 MPa
میجابسکال 0,3

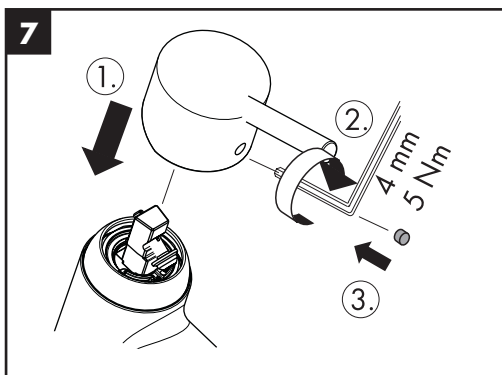
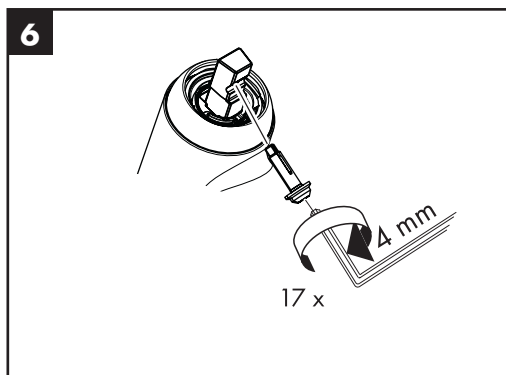
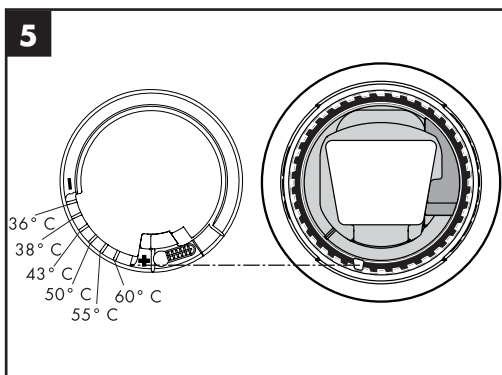
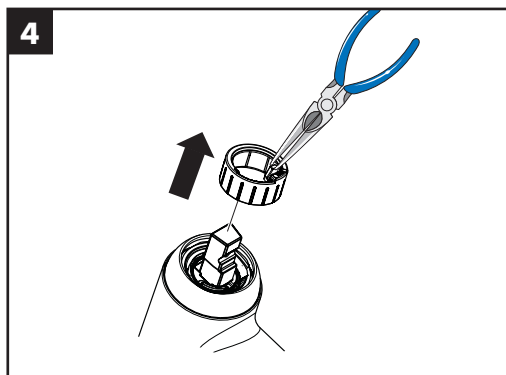
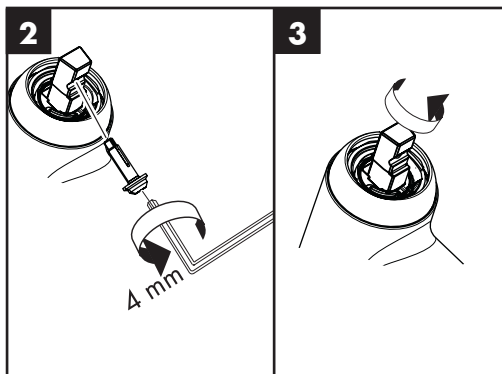
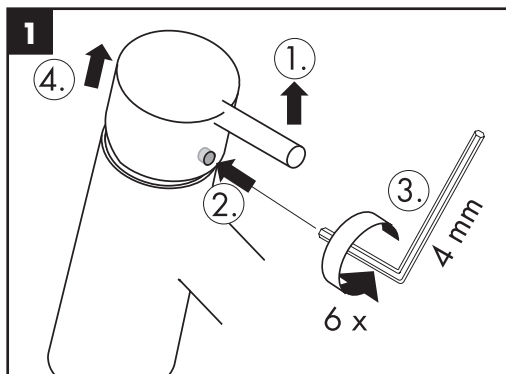



MyCube

71241000

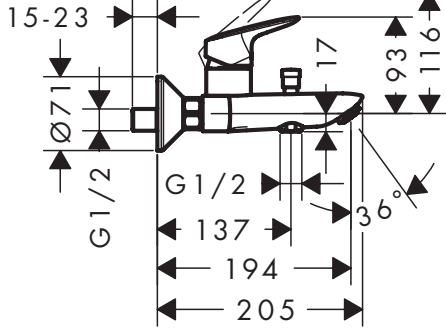

MySport

71242000

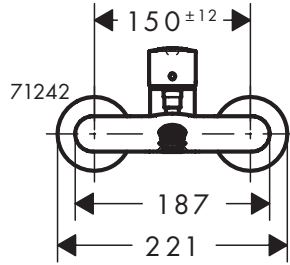
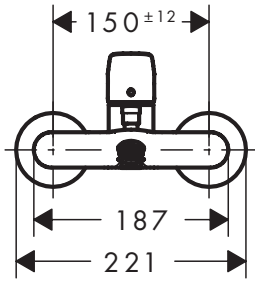
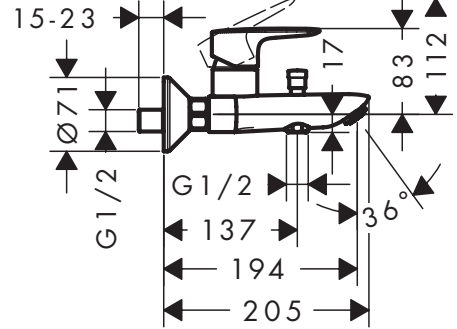

MyCube 71241000

MySport 71242000

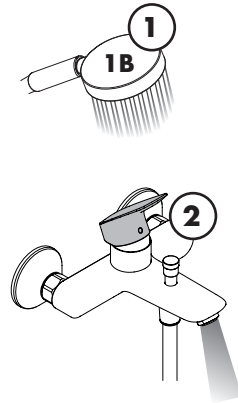
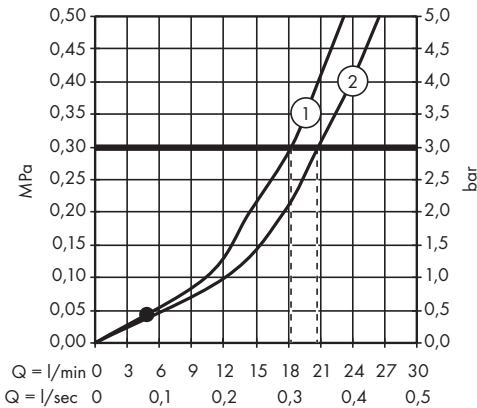

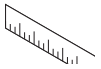

MyCube

71261000

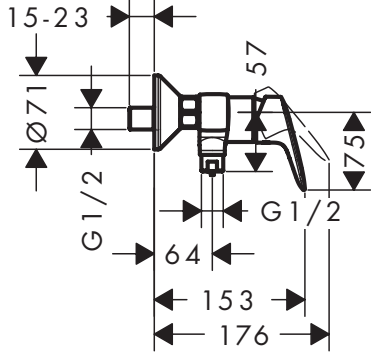

MySport

71262000

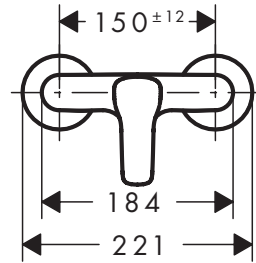
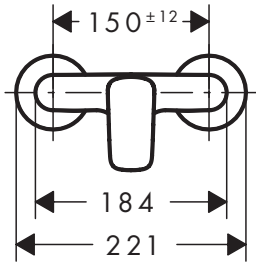
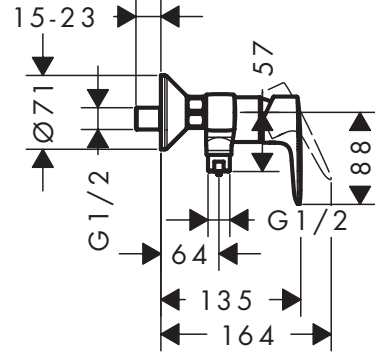

MyCube 71261000

MySport 71262000

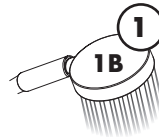
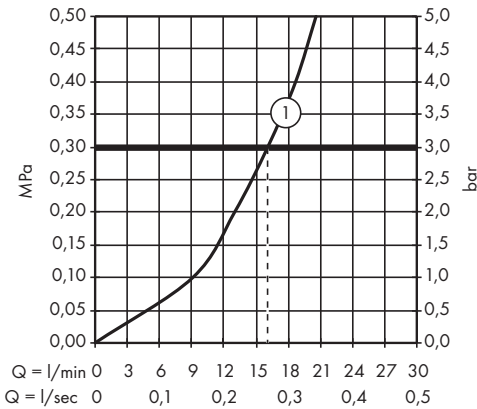



MyCube
71241000

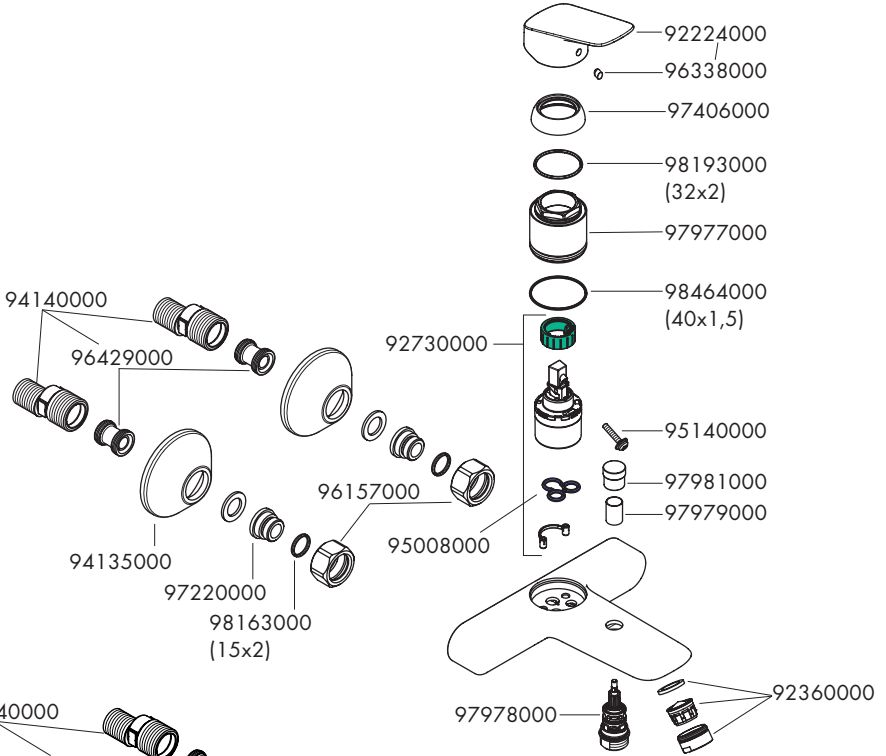

MyCube
71261000

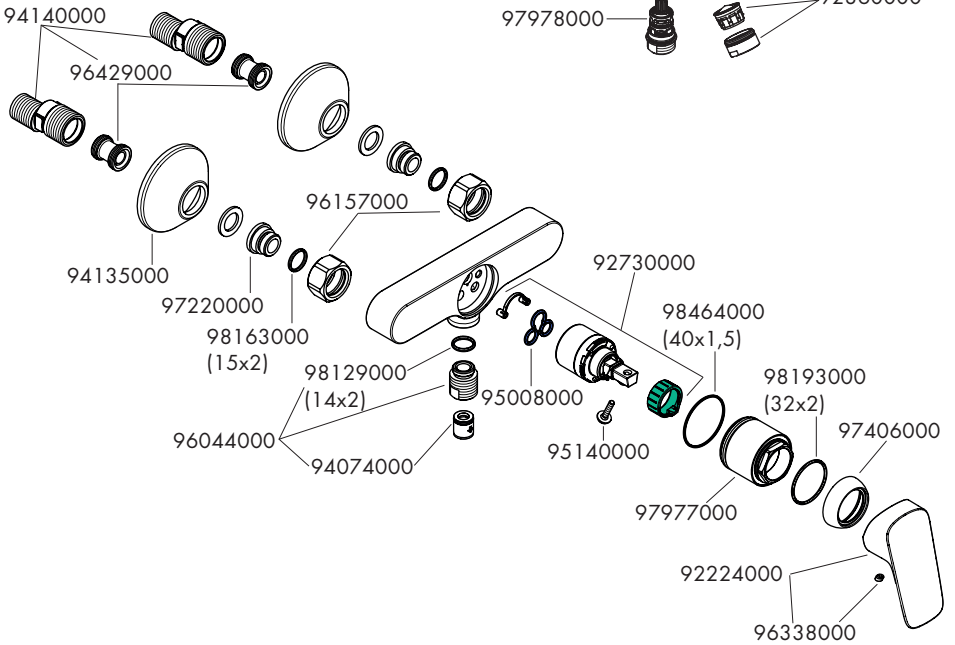



MySport
71242000

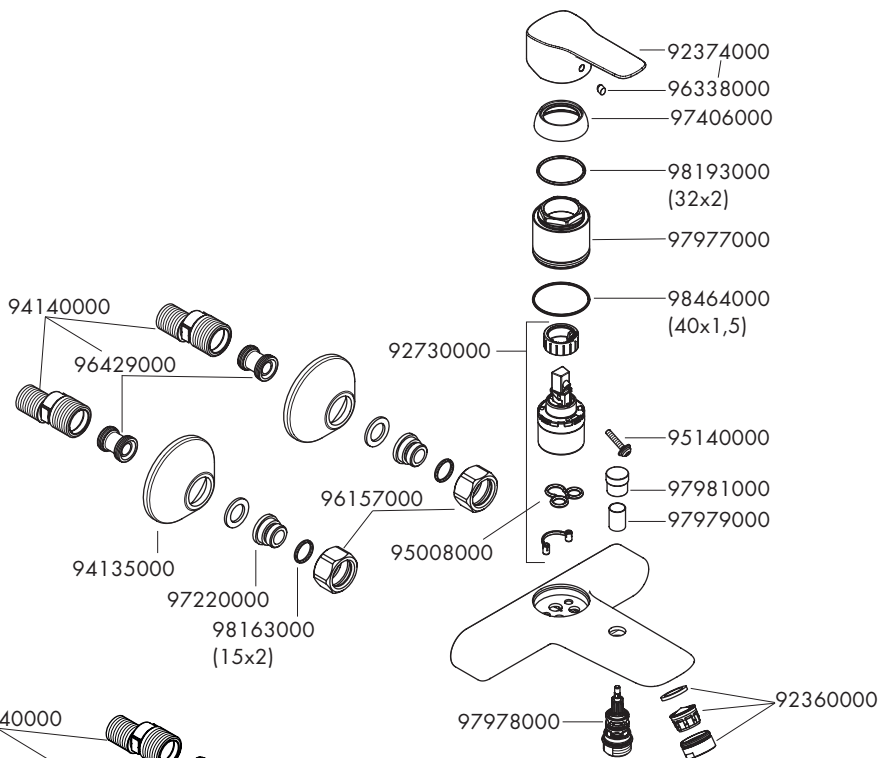

MySport
71262000

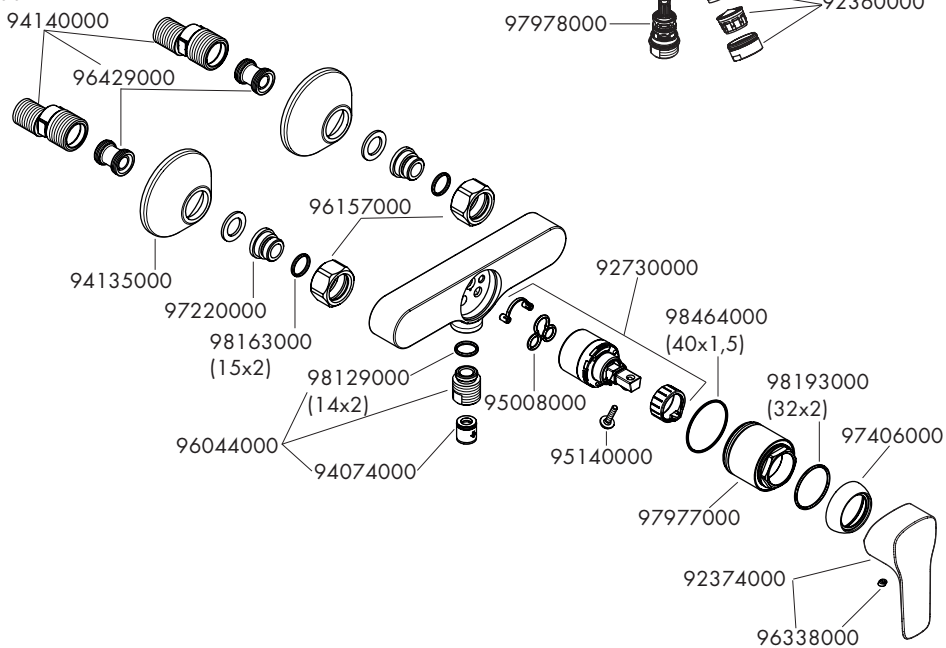

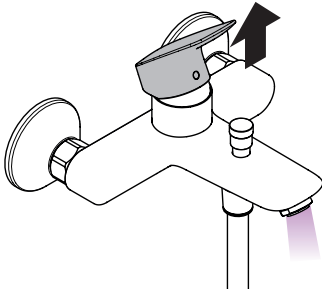

öffnen / ouvert / open / aperto / abierto / open / åbne /
 abrir / otworzyć / otevřít / otvorit / 开 / открыть / nyitás /
 avaaminen / öppna / atidaryti / Отваранье / açmak /
 deschide / ανοικτό / odpreti / avage / atvērt / otvoriti /
 åpne / отварање / hare / فتح

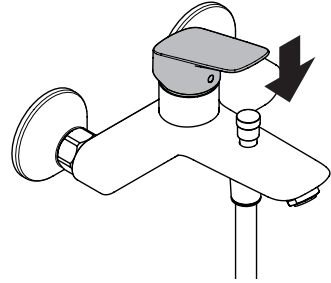

schließen / fermé / close / chiudere / cerrar / sluiten /
 lukke / fechar / zamknąć / zavřít / uzavriet / 关 /
 закрыть / bezárás / sulkeminen / stänga / uždaryti /
 Zatvaranje / kapatmak / închide / κλειστό / zapreti /
 sulgege / aizvērt / zatvori / lukke / затварање / mbylle /
 إغلاق

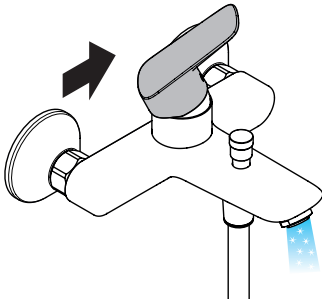

kalt / froid / cold / freddo / frío / koud / koldt / fria /
 zīma / studená / studená / 冷 / холодная / hideg /
 kylmä / kallt / šaltas / Hladno / soğuk / reše / κρύο /
 mrzlo / külm / auksts / hladno / kaldt / студено / i ftohtë /
 بارد

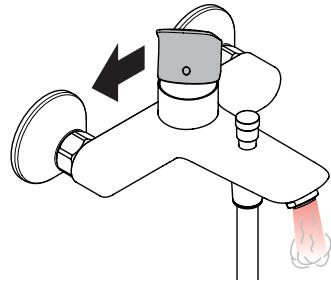

warm / chaud / hot / caldo / caliente / varm / varmt /
 quente / ciepła / teplá / teplá / 热 / горячая / meleg /
 lämmin / varmt / karštas / Vruća voda / sıcak / cald /
 ζεστό / toplo / kuum / karsts / topla / varm / топло / i
 ngrohtë / ساخن

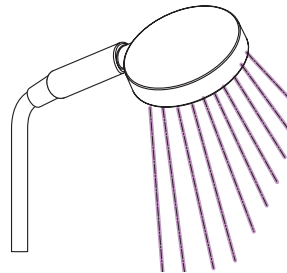
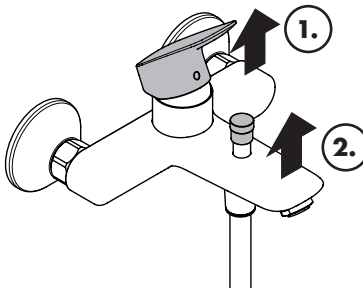



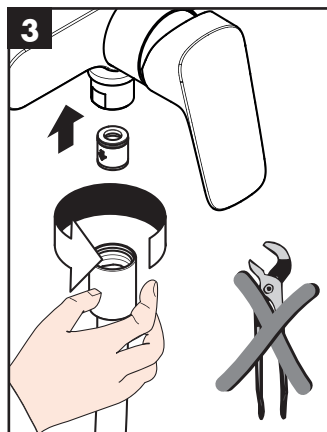
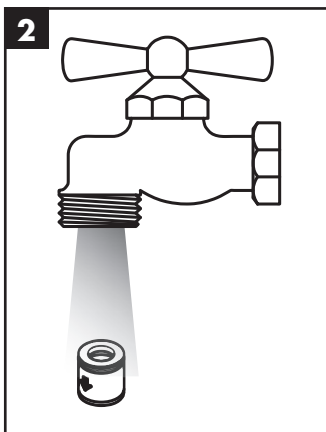
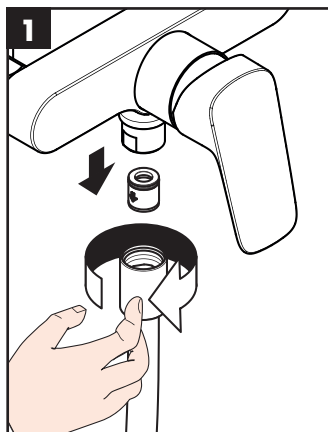

	P-IX	DVGW	SVGW	ACS	WRAS	ETA
71241000				X		
71242000				X		
71261000				X		
71262000				X		