

DE	Gebrauchsanleitung / Montageanleitung	2
FR	Mode d'emploi / Instructions de montage	3
EN	Instructions for use / assembly instructions	4
IT	Istruzioni per l'uso / Istruzioni per Installazione	5
ES	Modo de empleo / Instrucciones de montaje	6
NL	Gebruiksaanwijzing / Handleiding	7
DK	Brugsanvisning / Monteringsvejledning	8
PT	Instruções para uso / Manual de Instalação	9
PL	Instrukcja obsługi / Instrukcja montażu	10
CS	Návod k použití / Montážní návod	11
SK	Návod na použitie / Montážny návod	12
ZH	用户手册 / 组装说明	13
RU	Руководство пользователя / Инструкция по монтажу	14
HU	Használati útmutató / Szerelési útmutató	15
FI	Käyttöohje / Asennusohje	16
SV	Bruksanvisning / Monteringsanvisning	17
LT	Vartotojo instrukcija / Montavimo instrukcijos	18
HR	Upute za uporabu / Uputstva za instalaciju	19
TR	Kullanım kılavuzu / Montaj kılavuzu	20
RO	Manual de utilizare / Instrucțiuni de montare	21
EL	Οδηγίες χρήσης / Οδηγία συναρμολόγησης	22
SL	Navodilo za uporabo / Navodila za montažo	23
ET	Kasutusjuhend / Paigaldusjuhend	24
LV	Lietošanas pamācība / Montāžas instrukcija	25
SR	Uputstvo za upotrebu / Uputstvo za montažu	26
NO	Bruksanvisning / Montasjeveiledning	27
BG	Инструкция за употреба / Ръководство за монтаж	28
SQ	Udhëzuesi i përdorimit / Udhëzime rreth montimit	29
AR	دليل الاستخدام / تعليمات التجميع	30



Unica Reno
27704000



Ihr Online-Fachhändler für:

hansgrohe

- Kostenlose und individuelle Beratung
- Hochwertige Produkte
- Kostenloser und schneller Versand

- TOP Bewertungen
- Exzelerter Kundenservice
- Über 20 Jahre Erfahrung



E-Mail: info@unidomo.de | Tel.: 04621 - 30 60 89 0 | www.unidomo.de



Sicherheitshinweise

- ⚠ Bei der Montage müssen zur Vermeidung von Quetsch- und Schnittverletzungen Handschuhe getragen werden.
- ⚠ Das Produkt darf nicht als Haltegriff benutzt werden. Es muss ein separater Haltegriff montiert werden.
- ⚠ Brausenschläuche sind nur zum Anschluss von Brausen an Armaturen geeignet. Eine Absperrung nach dem Schlauch in Fließrichtung ist unzulässig!

Montagehinweise

- Vor der Montage muss das Produkt auf Transportschäden untersucht werden. Nach dem Einbau werden keine Transport- oder Oberflächenschäden anerkannt.
- Thermostat: Bedienung / Montage siehe beiliegende Broschüre.
- Bei der Montage des Produktes durch qualifiziertes Fachpersonal ist darauf zu achten, dass die Befestigungsfläche im gesamten Bereich der Befestigung plan ist (keine vorstehenden Fugen oder Fliesenversatz), der Wandaufbau für eine Montage des Produktes geeignet ist und keine Schwachstellen aufweist. Die beigelegten Schrauben und Dübel sind nur für Beton geeignet. Bei anderen Wandaufbauten sind die Herstellerangaben des Dübelherstellers zu beachten.
- Optimale Funktion nur in Verbindung mit Hansgrohe Handbrausen und Hansgrohe Brausenschläuchen garantiert.

Symbolerklärung



Kein essigsäurehaltiges Silikon verwenden!



Maße (siehe Seite 32)



Bedienung (siehe Seite 34)



Reinigung

siehe beiliegende Broschüre.



Serviceteile (siehe Seite 35)



Demontage (siehe Seite 36)





Consignes de sécurité

- ⚠ Lors du montage, porter des gants de protection pour éviter toute blessure par écrasement ou coupure.
- ⚠ Le produit ne doit pas servir de poignée. Monter pour cela une poignée séparée.
- ⚠ Les flexibles de douche ne doivent être utilisés que pour le raccordement d'une douche à main à un robinet. Le montage d'un système d'arrêt après le flexible, en direction du courant d'eau est strictement interdit.

Instructions pour le montage

- Avant son montage, s'assurer que le produit n'a subi aucun dommage pendant le transport. Après le montage, tout dommage de transport ou de surface ne pourra pas être reconnu.
- Mitigeur thermostatique: Instructions de service / Montage voir la brochure ci-jointe.
- Lors du montage du produit par un ouvrier qualifié, il faut faire attention à ce que la surface de fixation soit plane sur toute son étendue (aucun dépassement de joint ni de carrelage), que la construction de la paroi soit adaptée à l'installation du produit et surtout ne présente aucun point faible. Les vis et les chevilles fournies sont uniquement appropriées au béton. Pour les autres constructions, il faudra tenir compte des préconisations du fabricant de cheville.
- Un fonctionnement optimal est seulement garanti en combinaison avec des douches à main et des flexibles Hansgrohe.

Description du symbole



Ne pas utiliser de silicone contenant de l'acide acétique!



Dimensions (voir page 32)



Instructions de service (voir page 34)



Nettoyage

voir la brochure ci-jointe.



Pièces détachées (voir pages 35)





Démontage (voir page 36)



Montage voir page 31



Safety Notes

-  Gloves should be worn during installation to prevent crushing and cutting injuries.
-  The product may not be used as a holding handle. A separate handle must be installed.
-  Shower hoses are only suitable for a connection from the shower to the fitting. Never fit a shut-off device between the fitting and the hose.

Installation Instructions

- Prior to installation, inspect the product for transport damages. After it has been installed, no transport or surface damage will be honoured.
- Thermostatic mixer: Operation / Assembly see enclosed brochure.
- Where the contractor mounts the product, he should ensure that the entire area of the wall to which the mounting plate is to be fitted, is flat (no projecting joints or tiles sticking out), that the structure of the wall is suitable for the installation of the product and has no weak points. The enclosed screws and dowels are only suitable for concrete. For another wall constructions the manufacturer's indications of the dowel manufacturer have to be taken into account.
- Optimal functioning is only guaranteed with the combination of Hansgrohe hand showers and Hansgrohe shower hoses.

Symbol description



Do not use silicone containing acetic acid!



Dimensions (see page 32)



Operation (see page 34)



Cleaning

see enclosed brochure.



Spare parts (see page 35)



Dismounting (see page 36)





Indicazioni sulla sicurezza

- ⚠ Durante il montaggio, per evitare ferite da schiacciamento e da taglio bisogna indossare guanti protettivi.
- ⚠ Il prodotto non deve essere utilizzato come maniglia, questa deve essere montata separatamente.
- ⚠ I flessibili devono essere inseriti solo tra l'uscita dell'acqua e la doccetta. Non deve essere introdotta alcuna prolunga tra il flessibile e l'uscita dell'acqua.

Istruzioni per il montaggio

- Prima del montaggio è necessario controllare che non ci siano stati danni durante il trasporto. Una volta eseguito il montaggio, non verranno riconosciuti eventuali danni di trasporto o delle superfici.
- Termostatico: Procedura / Montaggio vedi il prospetto accluso.
- Quando il personale tecnico specializzato esegue il montaggio del prodotto è necessario assicurarsi che la superficie di fissaggio sia piana in tutta l'area di fissaggio (senza giunti sporgenti o spostamento delle piastrelle), che la struttura della parete sia adatta per il montaggio del prodotto e soprattutto che non ci siano dei punti deboli. Le viti e i tasselli in dotazione sono adatti solo per calcestruzzo. In caso di altre strutture della parete vanno osservare le indicazioni del produttore dei tasselli.
- Funzionalità ottimale solamente in combinazione con doccette e flessibili Hansgrohe.

Descrizione simbolo



Non utilizzare silicone contenente acido acetico!



Ingombri (vedi pagg. 32)



Procedura (vedi pagg. 34)



Pulitura

vedi il prospetto accluso.



Parti di ricambio (vedi pagg. 35)



Smontaggio (vedi pagg. 36)



Montaggio vedi pagg. 31



Indicaciones de seguridad

- ⚠ Durante el montaje deben utilizarse guantes para evitar heridas por aplastamiento o corte.
- ⚠ El producto no debe ser utilizado como un elemento de sujeción. Debe montarse un elemento de sujeción separado.
- ⚠ Los flexos deben usarse exclusivamente para la conexión entre grifería y teleducha. Cualquier función de cierre tras el flexo y en la dirección del flujo del agua no está permitida.

Indicaciones para el montaje

- Antes del montaje se debe examinarse el producto contra daños de transporte. Después de la instalación so se reconoce ningún daño de transporte o de superficie.
- Termostato: Manejo / Montaje ver el folleto adjunto.
- En el momento del montaje del producto por parte de personal especializado y cualificado se deberá prestar una atención especial a que la superficie de fijación en toda el área de la fijación sea plana (sin juntas que sobresalen ni azulejos desplazados), que la estructura de la pared sea adecuada para un montaje del producto y que, ante todo, no presente puntos débiles. Los tornillos y tacos adjuntos son sólo apropiados para hormigón. En el caso de otras estructuras murales se deberán considerar las indicaciones del fabricante de tacos.
- Sólo se garantiza una función óptima en combinación con teleduchas y flexos de Hansgrohe.

Descripción de símbolos



No utilizar silicona que contiene ácido acético!



Dimensiones (ver página 32)



Manejo (ver página 34)



Limpiar

ver el folleto adjunto.



Repuestos (ver página 35)



Despiece (ver página 36)





Veiligheidsinstructies

- ⚠ Bij de montage moeten ter voorkoming van kniel- en snijwonden handschoenen worden gedragen.
- ⚠ Het product mag niet als handgreep worden gebruikt. Er moet een aparte handgreep gemonteerd worden.
- ⚠ De doucheslangen zijn alleen geschikt voor de aansluiting van douches aan kranen. Een versperring ná de doucheslang in de stroomrichting is niet toelaatbaar.

Montage-instructies

- Vóór de montage moet het product gecontroleerd worden op transportschade. Na de inbouw wordt geen transport- of oppervlakteschade meer aanvaard.
- Thermostaat: Bediening / Montage zie bijgevoegde brochure.
- Bij de montage van het produkt door een vakkundige installateur moet men erop letten dat het bevestigingsoppervlak op één oppervlak zit (dus geen opliggende voegen of verspringende tegels), de wand geschikt is voor montage van produkten en zeker geen zwakke plekken bevat. De bijgevoegde schroeven en duvels zijn alleen geschikt voor beton. Bei andere wandsoorten dient u te letten op de voorschriften van de fabrikant van de schroeven en duvels.
- Optimal funktionieren gegarandeerd bij kombinatie met Hansgrohe handdouche en doucheslang.

Symboolbeschrijving



Gebruik geen zuurhoudende silicone!



Maten (zie blz. 32)



Bediening (zie blz. 34)



Reinigen

zie bijgevoegde brochure.



Service onderdelen (zie blz. 35)



Demontage (zie blz. 36)



Montage zie blz. 31



Sikkerhedsanvisninger

- ⚠ Ved monteringen skal der bruges handsker for at undgå kvæstelser og snitsår.
- ⚠ Produktet må ikke bruges som håndtag. Der skal monteres et separat håndtag.
- ⚠ Bruserslanger bør kun anvendes i forbindelse med tilslutning mellem brusere og armatur. Det er ikke tilladt at montere en afspærringsventil mellem brusere og slange!

Monteringsanvisninger

- Før monteringen skal produktet kontrolleres for transportskader. Efter monteringen godkendes transportskader eller skader på overfladen ikke længere.
- Termostat: Brugsanvisning / Montering se venligst den vedlagte brochure.
- Ved montering er det vigtigt at sikre sig, at hele befæstigelsesfladen er plan (ingen ujævne fuger eller fliser), samt at væggen er egnet til montering af produktet og specielt, at væggen ikke har nogen svage punkter. De medfølgende skrue og dübler er kun egnet til beton. Ved anden vægopbygning bør producenten af dübler kontaktes for nærmere information.
- Optimal funktion garanteres for anvendelse i forbindelse med Hansgrohe håndbrusere og Hansgrohe bruserslanger.

Symbolbeskrivelse



Der må ikke benyttes eddikesyreholdig silikone!



Målene (se s. 32)



Brugsanvisning (se s. 34)



Rengøring

se venligst den vedlagte brochure.



Reserve dele (se s. 35)



Afmontere (se s. 36)





Avisos de segurança

- ⚠ Durante a montagem devem ser utilizadas luvas de protecção, de modo a evitar ferimentos resultantes de entalamentos e de cortes.
- ⚠ O produto não pode ser utilizado como pega de apoio. Tem que ser montada uma pega separada.
- ⚠ Os tubos flexíveis são apenas adequados para uma ligação do chuveiro à misturadora. Nunca instale uma válvula de corte entre a misturadora e o tubo flexível.

Avisos de montagem

- Antes da montagem deve-se controlar o produto relativamente a danos de transporte. Após a montagem não são aceites quaisquer danos de transporte ou de superfície.
- Misturadora termostática: Funcionamento / Montagem consultar a seguinte brochura.
- Durante a montagem do produto por técnicos qualificados, deve ter-se em atenção que a superfície de fixação seja plana em toda a área da fixação (sem juntas sobrepostas/salientes ou ladrilhos deslocados), que o dispositivo de montagem na parede seja adequado para uma montagem na parede e que este não apresente nenhuns pontos fracos. Os parafusos e buchas incluídos no volume de fornecimento são apenas adequados para betão. Para outros métodos de montagem na parede devem ser respeitadas as indicações do fabricante das buchas.
- O bom funcionamento é apenas garantido em combinação com chuveiros de mão e tubos flexíveis Hansgrohe.

Descrição do símbolo



Não utilizar silicone que contenha ácido acético!



Medidas (ver página 32)



Funcionamento (ver página 34)



Limpeza

consultar a seguinte brochura.



Peças de substituição (ver página 35)





Desmontar (ver página 36)





Wskazówki bezpieczeństwa

-  Aby uniknąć zranień, takich jak zgniecenia czy przecięcia, podczas montażu należy nosić rękawice.
-  Produktu nie wolno używać jako uchwytu do trzymania się. Należy zamontować osobny uchwyt.
-  Wężę prysznicowe przeznaczone są do podłączenia tylko z armaturą. Blokada za wężem w kierunku przepływu jest niedopuszczalna.

Wskazówki montażowe

- Przed montażem należy skontrolować produkt pod kątem szkód transportowych. Po montażu nie widać żadnych szkód transportowych ani szkód na powierzchni.
- Termostat: Obsługa / Montaż patrz dołączona broszura.
- Przy montażu produktu przez wykwalifikowany personel fachowy należy zwracać na to, by powierzchnia mocowania na całym obszarze mocowania była równa (by nie było szczelin wzgl. wzajemnie przesuniętych płytek), rodzaj ściany nadawał się do montażu produktu i zwłaszcza, by nie było żadnych słabych stron. Umieszczone w dostawie śruby i kołki rozporowe są przeznaczone tylko do betonu. Przy innych rodzajach montażu ścianowego należy przestrzegać danych producenta kołków rozporowych.
- Optymalne działanie gwarantuje się tylko w odniesieniu do pryszniców ręcznych i węży prysznicowych Hansgrohe.

Opis symbolu



Nie stosować silikonów zawierających kwas octowy!



Wymiary (patrz strona 32)



Obsługa (patrz strona 34)



Czyszczenie

patrz dołączona broszura.



Części serwisowe (patrz strona 35)





Demontaż (patrz strona 36)





Bezpečnostní pokyny

-  Pro zabránění řezným zraněním a pohmožděním je nutné při montáži nosit rukavice.
-  Produkt nesmí být používán jako madlo. Je nutné namontovat samostatné madlo.
-  Sprchové hadice jsou vhodné pouze pro napojení sprch na armatury. Řazení uzavíracího ventilu za hadicí po směru toku je nepřipustné!

Pokyny k montáži

- Před montáží je třeba produkt zkontrolovat, zda nebyl při transportu poškozen. Po zabudování nebudou uznány žádné škody způsobené transportem nebo poškození povrchu.
- Termostat: Ovládání / Montáž viz příložená brožura.
- Při montáži produktu kvalifikovaným odborným personálem je třeba dbát na to, aby upevňovací plochy byly v celém rozsahu upevnění rovné (žádné vyčnívající spáry nebo navzájem přesazené oblady), aby konstrukce stěny byla pro montáž produktu vhodná a zvláště aby v ní nebyla žádná slabá místa. Příložené vruty a hmoždinky jsou vhodné pouze pro beton. Při jiných konstrukčních materiálech stěny je třeba se řídit údaji výrobce hmoždinek.
- Optimální funkce je zaručena pouze s ručními sprchami a sprchovými hadicemi Hansgrohe.

Popis symbolů



Nepoužívat silikon s obsahem kyseliny octové!



Rozměry (viz strana 32)



Ovládání (viz strana 34)



Čištění

viz příložená brožura.



Servisní díly (viz strana 35)



Demontáž (viz strana 36)





Bezpečnostné pokyny

- ⚠ Pri montáži musíte nosiť rukavice, aby ste predišli pomliaždeninám a rezným poraneniam.
- ⚠ Výrobok sa nesmie používať ako držadlo. K tomu účelu sa musí namontovať samostatné držadlo.
- ⚠ Sprchové hadice sú vhodné iba pre napojenie sprách na batérie. Umiestnenie uzatváracieho ventilu za hadicou v smere toku je neprípustné.

Pokyny pre montáž

- Pred montážou musíte produkt skontrolovať, či nebol počas transportu poškodený. Po zabudovaní nebudú uznané žiadne škody spôsobené transportom alebo poškodenia povrchu.
- Termostatická batéria: Obsluha / Montáž nájdete v priloženej brožúre.
- Pri montáži produktu kvalifikovaným odborným personálom je nutné dbať na to, aby upevňovacie plochy boli v celom rozsahu upevnenia rovné (žiadne vyčnievajúce škáry alebo navzájom predsadené obklady), aby konštrukcia steny bola pre montáž produktu vhodná a zvlášť aby v nej neboli žiadne slabé miesta. Priložené vruty a hmoždinky sú vhodné len pre betón. Pri iných konštrukčných materiáloch steny je nutné riadiť sa údajmi výrobcu hmoždiniek.
- Optimálna funkcia je zaručená iba s ručnými sprchami a sprchovými hadicami Hansgrohe.

Popis symbolov



Nepoužívať silikón s obsahom kyseliny octovej!



Rozmery (viď strana 32)



Obsluha (viď strana 34)



Čistenie

nájdete v priloženej brožúre.



Servisné diely (viď strana 35)



Demontáž (viď strana 36)





⚠️ 安全技巧

- △ 装配时为避免挤压和切割受伤，必须戴上手套。
- △ 该产品不得作扶柄使用。必须安装单独的扶柄。
- △ 淋浴软管只适合从淋浴器连接到管接头。切勿在管接头和软管之间安装截止装置。

安装提示

- 安装前必须检查产品是否受到运输损害。安装后将不认可运输损害或表面损伤。
- 恒温龙头: 操作 / 安装 附有小手册
- 在安装产品的位置，安装人员必须确保安装面的墙面是平的（没有突出物或瓷砖没有突起），墙体结构适合产品的安装并没有弱点。包装内的膨胀螺丝只适用于混凝土墙体。对于其他墙体结构必须咨询膨胀螺丝生产商的建议。
- 只有与汉斯格雅手提花洒和汉斯格雅淋浴器软管组合使用，方担保最佳的功能。

符号说明

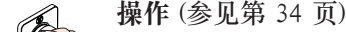
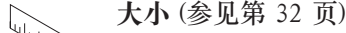
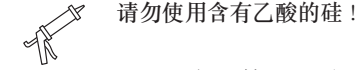

安装 参见第 31 页



Указания по технике безопасности

- ⚠ Во время монтажа следует надеть перчатки во избежание прищемления и порезов.
- ⚠ Изделие запрещается использовать в качестве рукоятки. Следует устанавливать специальную рукоятку.
- ⚠ Душевые шланги подходят только для подсоединения душей к арматуре. Не устанавливайте дополнительных затворов между шлангом и арматурой!

Указания по монтажу

- Перед монтажом следует проверить изделие на предмет повреждений при перевозке. После монтажа претензии о возмещении ущерба за повреждения при перевозке или повреждения поверхностей не принимаются.
- Термостат: Эксплуатация / Монтаж см прилагаемая брошюра
- При монтаже изделия квалифицированным персоналом необходимо следить за тем, чтобы, поверхность крепления была плоской во всей зоне крепления (без выступающих швов или смещения плитки), структура стен подходила для монтажа изделия и, в частности, не имела слабых мест. Прилагаемые винты и дюбели предназначены только для бетона. При других типах стен необходимо соблюдать указания производителей дюбелей.
- Оптимальное функционирование гарантируется только при использовании в комбинации с ручными душами Hansgrohe и душевыми шлангами Hansgrohe.

Описание символов



Не применяйте силикон, содержащий искусственную кислоту.



Размеры (см. стр. 32)



Эксплуатация (см. стр. 34)



Очистка

см прилагаемая брошюра



Комплект (см. стр. 35)



Демонтаж (см. стр. 36)





Biztonsági utasítások

- ⚠ A szerelésnél a zúzódások és vágási sérülések elkerülése érdekében kesztyűt kell viselni.
- ⚠ A terméket nem szabad kapaszkodónak használni. Ehhez külön kapaszkodót kell felszerelni.
- ⚠ A zuhanycsövek kizárólag zuhanyok csaptelepekkel való összekötésére alkalmasak. A zuhanycső után (folyásirány szerint) elzárás beszerelése nem engedélyezett!

Szerelési utasítások

- A szerelés előtt ellenőrizni kell, hogy a terméknek nincs-e szállítási sérülése. Beépítés után a szállítási- vagy felületi sérüléseket nem ismerik el.
- Termosztát: Használat / Szerelés lásd a mellékelt brosúrát.
- Miközben szakképzett szakember végzi a termék felszerelését, ügyelni kell arra, hogy a rögzítési felületek a rögzítési terület teljes egészén síkok (nincsenek kiálló fugák vagy csempezélek), a fal felépítése alkalmas a termék felszereléséhez, és különösképpen, hogy nincsenek benne gyenge pontok. A mellékelt csavarok és dübelek csak betonhoz alkalmasak. Egyéb falzatoknál figyelembe kell venni a dübelgyártó gyártói utasításait.
- A megfelelő működést csak Hansgrohe kézi zuhanyokkal és Hansgrohe zuhanycsövekkel garantáljuk.

Szimbólumok leírása



Ne használjon ecetsavtartalmú szilikon!



Méretet (lásd a 32. oldalon)



Használat (lásd a 34. oldalon)



Tisztítás

lásd a mellékelt brosúrát.



Tartozékok (lásd a 35. oldalon)



Leszerelés (lásd a 36. oldalon)



Szerelés lásd a 31. oldalon



Turvallisuusohjeet

- ⚠ Asennuksessa on käytettävä käsineitä puristumien ja viltojen aiheuttamien tapaturmien estämiseksi.
- ⚠ Tuotetta ei saa käyttää kädensijana. On asennettava erillinen kädensija.
- ⚠ Suihkuletkut soveltuvat vain käsisuihkun liittämiseen armatuureihin. Letkun jälkeen virtaussuunnassa oleva sulkuventtiili ei ole sallittua!

Asennusohjeet

- Ennen asennusta on tarkastettava tuotteen mahdolliset kuljetusvahingot. Asennuksen jälkeen kuljetus- ja pintavaurioita ei hyväksytä.
- Termostaatti: Käyttö / Asennus katso oheinen esite
- Kun pätevä ammattihenkilöstö suorittaa tuotteen asennusta, on huomioitava, että kiinnityspinta on koko kiinnityksen alueella tasainen (ei ulkonevia saumoja tai laattojen tasomuutoksia) ja, että seinän rakenne soveltuu tuotteen asentamiseen eikä siinä ole heikkoja kohtia. Mukana olevat kiinnitysruuvit ja kiinnitysankkurit soveltuvat betoniin kiinnittämiseen. Kiinnittäessä tuotetta muihin seinä rakenteisiin, noutata kiinnittimien valmistajan ohjeita.
- Optimaalinen toiminta on taattuna vain Hansgrohe käsisuihkuja ja Hansgrohe suihkuletkuja käytettäessä.

Merkin kuvaus



Älä käytä etikkahappopitoista silikonia!



Mitat (katso sivu 32)



Käyttö (katso sivu 34)



Puhdistus

katso oheinen esite



Varaosat (katso sivu 35)



Irrotus (katso sivu 36)





Säkerhetsanvisningar

- ⚠ Handskar ska bäras under monteringsarbetet så att man kan undvika kläm- och skärskadorgen werden.
- ⚠ Produkten får inte användas som handtag. Ett separat handtag måste monteras.
- ⚠ Duschslangar är endast avsedda till att ansluta duschar på blandare. Det är inte tillåtet att lägga in en spärr efter slangen och i flödesriktningen!

Monteringsanvisningar

- Det måste undersökas om produkten har transportskador innan den monteras. Efter monteringen accepteras inga transport- eller ytskiktsskador.
- Termostat: Hantering / Montering se den medföljande broschyren
- När kvalificerad fackpersonal monterar produkten är det viktigt att tänka på att monteringsytan är plan i alla delar av arbetsytan (inga fogar som sticker ut eller klinkerförskjutningar), att väggkonstruktionen passar till montering av produkten samt att den inte har svaga punkter. Medföljande skruvar och plugg är endast avsedda för betong. Vid andra väggkonstruktioner skall anvisningarna från pluggtillverkaren beaktas.
- Optimal funktion garanteras bar tillsammans med Hansgrohe handduschar och Hansgrohe duschslangar.

Symbolförklaring



Använd inte silikon som innehåller ättiksyra!



Måtten (se sidan 32)



Hantering (se sidan 34)



Rengöring

se den medföljande broschyren



Reservdelar (se sidan 35)





Demontering (se sidan 36)





Saugumo technikos nurodymai

-  Apsaugai nuo užspaudimo ir įsijovimo montavimo metu mūvėkite pirštines.
-  Gaminys neturi būti naudojamas kaip rankena. Rankena montuojama atskirai.
-  Dušo žarnos yra pritaikytos tik prijungti dušo galvutę prie vandens maišytuvo. Negalima montuoti vandens uždarymo mechanizmo tarp maišytuvo ir žarnos.

Montavimo instrukcija

- Prieš montuojant būtina patikrinti, ar gaminys nebuvo pažeistas transportavimo metu. Sumontavus pretenzijos dėl transportavimo ir paviršiaus pažeidimų nepriimamos.
- Termostatas: Eksploatacija / Montavimas žr. pridedamoje brošiūroje.
- Montuojant produktą, specialistas privalo įsitikinti, kad sienos plotas, prie kurio dedama montavimo plokštė, yra lygus (jokių plytelių ar kitų nelygumų), kad sienos struktūra yra pritaikyta produkto montavimui ir neturi jokių silpnų vietų. Pakuotėje esantys varžtai ir kaiščiai yra skirti tik betonui. Esant kitokiai sienai, varžtus ir kaiščius reikia rinktis pagal paskirtį.
- Optimalus funkcionavimas yra garantuojamas tik naudojant "Hansgrohe" rankų dušus su "Hansgrohe" dušo žarnomis.

Simbolio aprašymas



Nenaudokite silikono, kurio sudėtyje yra acto rūgšties!



Išmatavimai (žr. psl. 32)



Eksploatacija (žr. psl. 34)



Valymas

žr. pridedamoje brošiūroje.



Atsarginės dalys (žr. psl. 35)



Išmontavimas (žr. psl. 36)





Sigurnosne upute

- ⚠ Prilikom montaže se radi sprječavanja prignječenja i posjekotina moraju nositi rukavice.
- ⚠ Proizvod ne smije služiti za pridržavanje. U tu se svrhu mora postaviti zaseban rukohvat.
- ⚠ Crijeva tuša prikladna su jedino za spajanje tuševa na armature. Nije dopušteno zatvaranje crijeva u smjeru protoka vode!

Upute za montažu

- Prije montaže mora se provjeriti je li proizvod oštećen prilikom transporta. Nakon ugradnje se ne priznaju nikakve reklamacije koje se odnose na površinska i transportna oštećenja.
- Termostat: Upotreba / Sastavljanje se u priloženoj brošuri.
- Kada proizvod montira kvalificirano stručno osoblje treba paziti da čitava površina na koju se učvršćuje bude ravna (bez istaknutih fuga ili krivljenja pločica), da je zidna konstrukcija primjerena montaži proizvoda te osobito da nema slabih mjesta. Priloženi vijci i moždanici prikladni su samo za beton. Kod drugih zidnih nadgradnji treba obratiti pažnju na navode proizvođača moždanika.
- Optimalno funkcioniranje zajamčeno je jedino u kombinaciji sa Hansgrohe ručnim tuševima i Hansgrohe crijevom za tuš.

Opis simbola



Nemojte koristiti silikon koji sadrži octenu kiselinu!



Mjere (pogledaj stranicu 32)



Upotreba (pogledaj stranicu 34)



Čišćenje

se u priloženoj brošuri.



Rezervni dijelovi (pogledaj stranicu 35)



rastavljanje (pogledaj stranicu 36)





Güvenlik uyarıları

- ⚠ Montaj esnasında ezilme ve kesilme gibi yaralanmaları önlemek için eldiven kullanılmalıdır.
- ⚠ Ürün tutma kolu olarak kullanılmamalıdır. Aynı bir tutma kolu monte edilmelidir.
- ⚠ Sözü geçen duş boruları, duş parçalarını yalnız donanım takımlarına bağlamaya yarar. Hortumun arkasından sonra akış yönünde kesmek yasaktır!

Montaj açıklamaları

- Montaj işleminden önce ürün nakliye hasarları yönünden kontrol edilmelidir. Montaj işleminden sonra nakliye veya yüzey hasarları için sorumluluk üstlenilmemektedir.
- Termostat: Kullanımı / Montajı birlikte verilen broşür
- Müteahhit, ürünü monteleyeceği yer, yani montaj plakasının monte edileceği duvar alanının tümü düz (herhangi bir eklem yerinin ya da duvar fayansının çıkıntısıyla) engellenmemiş, yapısı ürünü montelemeye uygun bir şekilde ve herhangi zayıf noktası olamamasını sağlamalıdır. Kaplı vidalar ve çubuklar sadece beton için uygundur. Başka duvar yapıları için, imalatçının çubuk imal edenin belirttiği hususlar dikkate alınmalıdır.
- Mümkün olduğu kadar iyi işlev, yalnız Hansgrohe elle duş parçaları ve Hansgrohe duş boruları kullanılırsa, garanti edilir.

Simge açıklaması



Asetik asit içeren silikon kullanmayın!



Ölçüleri (Bakınız sayfa 32)



Kullanımı (Bakınız sayfa 34)



Temizleme

birlikte verilen broşür



Yedek Parçalar (Bakınız sayfa 35)





Sökme (Bakınız sayfa 36)





Instrucțiuni de siguranță

-  La montare utilizați mănuși pentru evitarea contuziunilor și tăierii mâinilor.
-  Nu este permisă utilizarea produsului pe post de mâner. este nevoie de montarea unui mâner corespunzător.
-  Furtunul de duș poate fi utilizat numai pentru conectarea telefonului de duș la baterie. Nu este permisă montarea unui opritor la capătul furtunului!

Instrucțiuni de montare

- Înainte de instalare verificați, dacă produsul prezintă deteriorări de transport. După instalare garanția nu acoperă deteriorările de transport și cele de suprafață.
- Termostat: Utilizare / Montare vezi broșura alăturată.
- La montarea produsului de către un personal calificat trebuie să fiți atenți ca suprafața, unde se fixează produsul să fie plată pe toată suprafața utilizată (să nu existe rosturi sau faianțe proeminente), peretele să fie adecvat pentru montarea produsului și să nu există zone de rezistență redusă. Șuruburile și diblurile livrate sunt potrivite pentru ziduri de beton. La alte tipuri de zid respectați instrucțiunile producătorului diblului utilizat.
- Funcționarea optimă este garantată numai când este conectat la duș de mână și furtun de duș marca Hansgrohe.

Descrierea simbolurilor



Nu utilizați silicon cu conținut de acid acetic!



Dimensiuni (vezi pag. 32)



Utilizare (vezi pag. 34)



Curățare

vezi broșura alăturată.



Piese de schimb (vezi pag. 35)



Demontare (vezi pag. 36)



Montare vezi pag. 31



⚠ Υποδείξεις ασφαλείας

- ⚠ Για να αποφύγετε τραυματισμούς κατά τη συναρμολόγηση πρέπει να φοράτε γάντια.
- ⚠ Το προϊόν δεν επιτρέπεται να χρησιμοποιείται σαν λαβή στήριξης. Για τον σκοπό αυτό πρέπει να τοποθετηθεί ξεχωριστή λαβή στήριξης.
- ⚠ Το εύκαμπτο σπирάλ του καταιονιστήρα είναι κατάλληλο μόνο για τη σύνδεση του καταιονιστήρα χειρός με τη βάνα. Δεν επιτρέπεται καμία στρόφιγγα διακοπής μετά το σωλήνα στην κατεύθυνση ροής!

Οδηγίες συναρμολόγησης

- Πριν τη συναρμολόγηση πρέπει να εξεταστεί το προϊόν για ζημιές μεταφοράς. Μετά την εγκατάσταση δεν αναγνωρίζονται ζημιές από τη μεταφορά ή επιφανειακές ζημιές.
- Θερμοστάτης: Χειρισμός / Συναρμολόγηση βλ. συνημμένο φυλλάδιο
- Κατά τη συναρμολόγηση του προϊόντος από καταρτισμένο και εξειδικευμένο προσωπικό θα πρέπει να δοθεί προσοχή, ώστε η επιφάνεια στερέωσης στη συνολική περιοχή στερέωσης να είναι επίπεδη (να μην υπάρχουν προεξέχοντες αρμοί ή λιθογόμωση πλακιδίων), ώστε η κατασκευή του τοίχου να είναι κατάλληλη για τη συναρμολόγηση του προϊόντος και ώστε η επιφάνεια να μην παρουσιάζει αδύναμα σημεία. Οι συνημμένες βίδες και οι στυλίσκοι ενδείκνυνται μόνο για σκυρόδεμα. Σε άλλες επίτοιχες κατασκευές θα πρέπει να δοθεί προσοχή στα δεδομένα του Κατασκευαστή των στυλίσκων.
- Εγγύηση βέλτιστης λειτουργίας μόνο σε συνδυασμό με καταιονιστήρα χειρός Hansgrohe και σπирάλ Hansgrohe.

Περιγραφή συμβόλων



Μην χρησιμοποιείτε σιλικόνη που περιέχει οξικό οξύ!



Διαστάσεις (βλ. σελίδα 32)



Χειρισμός (βλ. σελίδα 34)



Καθαρισμός

βλ. συνημμένο φυλλάδιο



Ανταλλακτικά (βλ. σελίδα 35)



Αποσυναρμολόγηση (βλ. σελίδα 36)





Varnostna opozorila

- ⚠ Lors du montage, porter des gants de protection pour éviter toute blessure par écrasement ou coupure.
- ⚠ Proizvoda ne smete uporabljati kot drzalnega ročaja. V ta namen je treba montirati poseben ročaj.
- ⚠ Gibke cevi za prho so primerne le za povezavo prhe in armature. Naprave za zapiranje pretoka vode nikoli ne nameščajte med armaturo in cev.

Navodila za montažo

- Pred montažo je treba izdelek preveriti glede morebitnih transportnih poškodb. Po vgradnji transportne ali površinske poškodbe ne bodo več priznane.
- Termostat: Upravljanje / Montaža glejte priloženi brošuri.
- Kamorkoli bo pogodbenik namestil izdelek, mora poskrbeti, da je celotno območje stene na katero bo plošča nameščena ravno (brez štrlečih fug ali robov ploščic), ter da je struktura stene primerna za namestitvev in je brez šibkih točk. Priloženi vijaki in ležaji so primerni le za beton. Za ostale zidne konstrukcije je potrebno upoštevati proizvajalčeva navodila.
- Optimalno delovanje je zagotovljeno le v povezavi z ročnimi prhami Hansgrohe in gibkimi cevmi za prho Hansgrohe.

Opis simbola



Ne smete uporabiti silikona, ki vsebuje očetno kislino!



Mere (glejte stran 32)



Upravljanje (glejte stran 34)



Čiščenje

glejte priloženi brošuri.



Rezervni deli (glejte stran 35)





Demontaža (glejte stran 36)



Montaža Glejte stran 31.



Ohutusjuhised

-  Kandke paigaldamisel muljumis- ja löikevigastuste vältimiseks kindaid.
-  Toode ei tohi kasutada käepidemena. Paigaldage eraldi käepide.
-  Dušivoolikud sobivad üksnes duši ühendamiseks segistitega. Mingil juhul ei tohi vooliku ja segisti vahele asetada sulgurit.

Paigaldamisjuhised

- Enne paigaldamist tuleb toodet kontrollida transpordikahjustuste osas. Pärast paigaldamist ei tunnustata enam transpordi- või pinnakahjustuste kaebuseid.
- Termostaat: Kasutamine / Paigaldamine vt kaasasolevast brošüürist.
- Toote paigaldamisel peab töövõtja tagama, et kogu seinapind, kuhu paigaldusplaat kinnitatakse, on lame (ükski vuuk ega keraamiline plaat ei ulatu esile), ning et seinakonstruktsioon on toote paigaldamiseks sobiv ja sellel puuduvad nõrgad kohad. Kaasasolevad kruvid ja tüüblid sobivad üksnes betoonile. Muude seinakonstruktsioonide puhul tuleb arvesse võtta tüüblitootja esitatud tooteandmeid.
- Optimaalne funktsioneerimine on garanteeritud ainult koos Hansgrohe käsiduššide ja Hansgrohe dušivoolikutega.

Sümbolite kirjeldus



Ärge kasutage äädikhapet sisaldavat silikooni!



Mõõtude (vt lk 32)



Kasutamine (vt lk 34)



Puhastamine

vt kaasasolevast brošüürist.



Varuosad (vt lk 35)





Mahamonteerimine (vt lk 36)





Drošības norādes

-  Montāžas laikā, lai izvairītos no spiedumiem un iegriezumiem, nepieciešams nēsāt cimdus.
-  Šo produktu nedrīkst izmantot kā roku balstu. Nepieciešams uzmontēt atsevišķu roku balstu.
-  Dušas šļūtenes ir piemērotas tikai dušas pieslēgšanai pie jaucējkrāna. Nepieļaujama ir noslēgarmatūras pievienošana aiz šļūtenes plūsmas virzienā!

Norādījumi montāžai

- Pirms montāžas nepieciešams pārbaudīt, vai produktam transportēšanas laikā nav radušies bojājumi. Pēc iebūvēšanas bojājumi, kas radušies transportēšanas laikā, vai virsmas bojājumi netiek atzīti.
- Termostats: Lietošana / Montāža skatiet pievienotajā brošūrā.
- Ja izstrādājuma montāžu veic kvalificēti speciālisti, jāseko, lai nostiprināšanas virsma visā nostiprināšanas zonā būtu gluda (šuves un flīzes nav izvirzītas uz āru), lai sienas konstrukcija būtu piemērota izstrādājuma montāžai un būtu pietiekami izturīga. Komplektā esošās skrūves un dībeļi ir paredzēti tikai šī izstrādājuma nostiprināšanai. Ja sienas konstrukcija ir citāda, jāievēro dībeļu ražotāja norādījumi.
- Optimāla funkcija tiek garantēta tikai kombinācijā ar Hansgrohe rokas dušām un Hansgrohe dušas šļūtenēm.

Simbolu nozīme



Neizmantojiet silikonu, kas satur etiķskābi!



Izmērus (skat. 32. lpp.)



Lietošana (skat. 34. lpp.)



Tīrīšana

skatiet pievienotajā brošūrā.



Rezerves daļas (skat. 35. lpp.)



Demontāža (skat. 36. lpp.)





Sigurnosne napomene

- ⚠ Prilikom montaže se radi sprečavanja prignječenja i posekotina moraju nositi rukavice.
- ⚠ Proizvod se ne sme koristiti za kao ručka za pridržavanje. U tu svrhu se mora postaviti zaseban rukohvat.
- ⚠ Creva tuša prikladna su jedino za spajanje tuševa na armature. Nije dopušteno blokiranje creva u smeru protoka vode!

Instrukcije za montažu

- Pre montaže se mora proveriti da li je proizvod oštećen pri transportu. Nakon ugradnje se ne priznaju nikakve reklamacije koje se odnose na površinska i transportna oštećenja.
- Termostat: Rukovanje / Montaža vidi priloženoj brošuri.
- Kada proizvod montira kvalifikovano stručno osoblje treba paziti da čitava površina na koju se učvršćuje bude ravna (bez istaknutih fuga ili krivljenja pločica), da je zidna konstrukcija primerena montaži proizvoda, i posebno da nema slabih mesta. Priloženi zavrtnji i tiplovi prikladni su samo za beton. Kod drugih zidnih nadgradnji treba obratiti pažnju na navode proizvođača tiplova.
- Optimalno funkcionisanje je garantovano jedino u kombinaciji sa Hansgrohe ručnim tuševima i Hansgrohe crevom za tuš.

Opis simbola



Nemojte koristiti silikon koji sadrži sirćetnu kiselinu!



Mere (vidi stranu 32)



Rukovanje (vidi stranu 34)



Čišćenje

vidi priloženoj brošuri.



Rezervni delovi (vidi stranu 35)





rastavljanje (vidi stranu 36)





Sikkerhetshenvisninger

-  Bruk hansker under montasjen for å unngå klem- og kuttskader.
-  Produktet skal ikke brukes som holdegrep. Det skal monteres en separat holdegrep.
-  Dusj slanger er kun egnet for tilkobling av dusj til armaturer. Det er ikke tillatt med en avsperring etter slangen i gjennomstrømningsretning!

Montagehenvisninger

- Før montasjen skal produktet sjekkes for transportskader. Etter monteringen aksepteres ikke noen transport- eller overflateskader.
- Termostat: Betjening / Montasje se vedlagt brosjyre.
- Når kvalifisert fagfolk monterer produktet, skal man påse at hele området der produktet monteres er plant (ingen fremstående fuger eller flisekanter), at oppbygging av veggen er egnet for montasje av produktet og at veggen ikke viser noen svakpunkter. Medleverte skruer og plugg er egner seg kun for betong. Ved en annen veggoppbygging skal man ta hensyn til pluggprodusentens henvisninger.
- Optimal funksjon garanteres kun i forbindelse med Hansgrohe hånddusj og Hansgrohe dusjslanger.

Symbolbeskrivelse



Ikke bruk silikon som inneholder eddiksyre!



Mål (se side 32)



Betjening (se side 34)



Rengjøring

se vedlagt brosjyre.



Service-deler (se side 35)



Demontasje (se side 36)



Montasje se side 31



Указания за безопасност

- ⚠ При монтажа трябва да се носят ръкавици, за да се избегнат наранявания поради притискане или порязване.
- ⚠ Продуктът не бива да се използва като дръжка. Трябва да се монтира отделна дръжка.
- ⚠ Маркучите на разпръсквателите са подходящи само за свързване на разпръскватели към арматури. Не се допуска блокиране след маркуча по посоката на протичане!

Указания за монтаж

- Преди монтажа продуктът трябва да се провери за транспортни щети. След монтажа не се признават транспортни или повърхностни щети.
- Термостат: Обслужване / Монтаж от приложената брошура.
- При монтаж на продукта от квалифицирани специалисти да се внимава за това, закрепващата повърхност в целия диапазон на закрепването да бъде равна (без изпъкнали фуги или изместване на плочки), конструкцията на стената да е подходяща за монтаж на продукта и особено за това, да няма слаби места. Приложените винтове и дюбели са подходящи само за бетон. При други стенни конструкции да се спазват данните на производителя на дюбели.
- Оптималното функциониране се гарантира само във връзка с ръчните разпръскватели и маркучите на разпръскватели на Hansgrohe.

Описание на символите



Не използвайте силикон, съдържащ оцетна киселина!



Размери (вижте стр. 32)



Обслужване (вижте стр. 34)



Почистване

от приложената брошура.



Сервизни части (вижте стр. 35)





Демонтаж (вижте стр. 36)





Udhëzime sigurie

-  Për të evituar lëndimet e pickimeve ose të prerjeve gjatë procesit të montimit duhet që të vishni doreza.
-  Produkti nuk duhet të përdoret si dorëze mbajtëse. Duhet të montohet një dorëzë mbajtëse e veçantë
-  Zorra e dushit mund të përdoren vetëm për lidhjen e spërkatëseve me armaturën. Ndalohet bllokimi pas zorrës në drejtim të rrjedhjes!

Udhëzime për montimin

- Përpara montimit duhet që produkti të kontrollohet për dëmtime nga transporti. Pas instalimit nuk do të njihet asnjë dëmtim nga transporti ose dëmtim i sipërfaqes.
- Termostati: Përdorimi / Montimi shikoni broshurën bashkëngjitur.
- Gjatë montimit të produktit nga ana e personit të kualifikuar duhet pasur parasysh që e gjithë sipërfaqja mbërthyesë të jetë e drejtë (nuk duhet të ketë hapësira mes pllakave). Mbi të gjitha muri duhet të jetë i përshtatshëm për montim dhe nuk duhet të ketë pika të dobëta. Vidhat dhe kunjat e bashkangjitura janë të përshtatshme vetëm për beton. Te përbërja tjetër murore të merren parasysh të dhënat e prodhuesit të kunjave.
- Garantohet funksioni optimal vetëm në kombinim me spërkatëset Hansgrohe si dhe zorrat e dushit Hansgrohe.

Përshkrimi i simbolit



Mos përdorni silikon që në përbërje ka acid acetik.



Përmasat (shih faqen 32)



Përdorimi (shih faqen 34)



Pastrimi

shikoni broshurën bashkëngjitur.



Pjesë ndërrimi (shih faqen 35)



Çmontimi (shih faqen 36)





وصف الرمز

هام! لا تستخدم السليكون الذي يحتوي على أحماض!



أبعاد (راجع صفحة 32)



التشغيل (راجع صفحة 34)



التنظيف

راجع والكتيب المرفق



قطع الغيار (راجع صفحة 35)



فك التركيب (راجع صفحة 36)

تنبيهات الأمان 

⚠ يجب ارتداء قفازات اليد أثناء التركيب لتجنب حدوث أضرار الإنحشار أو الجروح.

⚠ ممنوع إستخدام المنتج كمقبض. يجب تركيب مقبض منفصل.

⚠ لا تصلح خراطيم الدش إلا للتوصيل من الدش إلى الوصلة. حذار من تركيب جهاز إغلاق بين الوصلة والخراطيم.

تعليمات التركيب

- قبل القيام بعملية التركيب، يجب فحص المنتج للتأكد من خلوه من أية تلفيات ناتجة عن النقل. بعد القيام بعملية التركيب، لن يتم الاعتراف بوجود أية تلفيات سطحية أو تلفيات ناتجة عن عملية النقل.
- ثرموستات: التشغيل / التركيب راجع والكتيب المرفق
- يجب الانتباه عند تركيب المنتج بواسطة فريق العمل المتخصص إلى أن جميع مواضع التثبيت جاهزة للتثبيت دون عوائق (خالية من المفصلات أو المصقات)، وأن الحائط جاهز لتركيب المنتج مع عدم احتوائه على أية أماكن ضعيفة. مبيبات المسامير (الفيشر) والمسامير نفسها مناسبة للحوائط الخرسانية فقط، ويجب الالتزام بتعليمات الجهة المصنعة لمبيبات المسامير عند التثبيت في أنواع أخرى من الحوائط.
- لا يمكن ضمان الحصول على الأداء الأمثل إلا من خلال الجمع بين الدش اليدوي إنتاج هانزجرهه وخراطيم الدش إنتاج هانزجرهه.



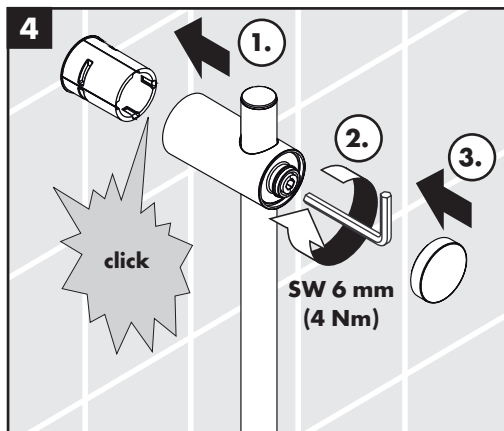
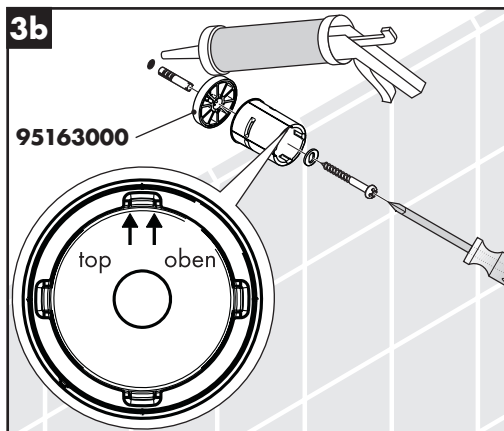
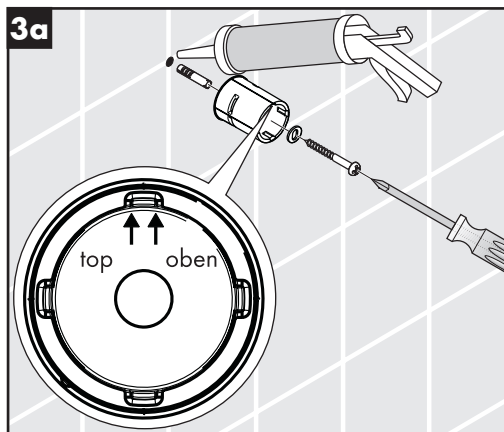
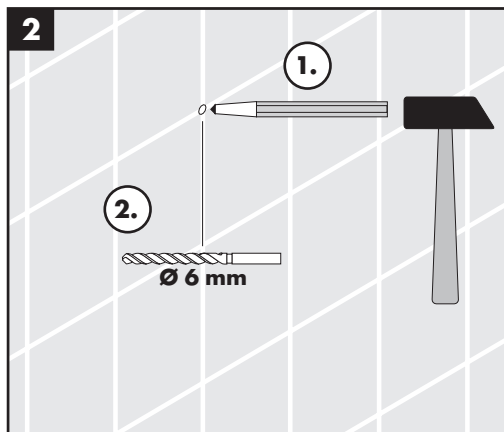
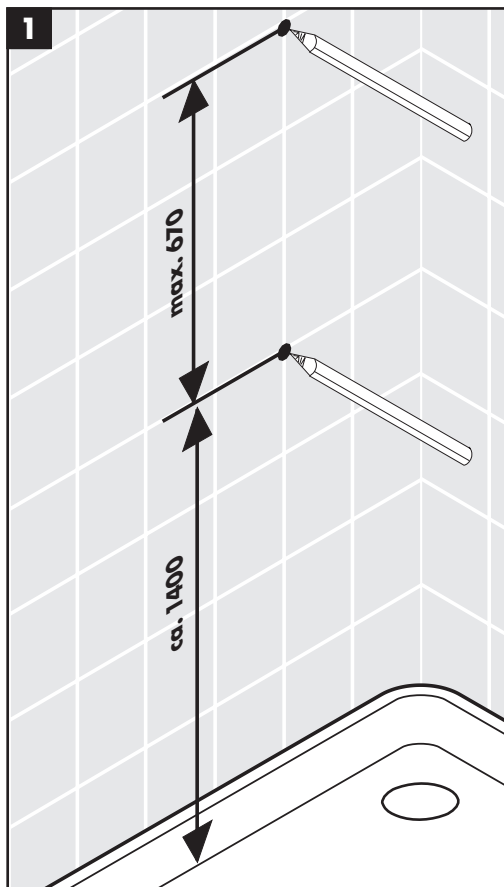



Unica Reno
27704000

