



**UNIDOMO®**

**Web:** [www.unidomo.de](http://www.unidomo.de)

**Telefon:** 04621- 30 60 89 0

**Mail:** [info@unidomo.com](mailto:info@unidomo.com)

**Öffnungszeiten:** Mo.-Fr. 8:00-17:00 Uhr

**VIESSMANN**

**Buderus**

 **Vaillant**

**WOLF**

 **JUNKERS**  **BOSCH**



 **remeha**



 **DAIKIN**

**ROTEX**

a member of DAIKIN group



-  Individuelle Beratung
-  Kostenloser Versand
-  Hochwertige Produkte

-  Komplettpakete
-  Über 15 Jahre Erfahrung
-  Markenhersteller

**DE** Einfach sauber: Kalk lässt sich von den Noppen ganz leicht abrubbeln.

**FR** La propreté en toute simplicité: les dépôts formés sur les buses élastiques en silicone s'éliminent par un simple passage de la main.

**EN** Just clean: simply rub over the spray nozzles to remove lime scale.

**LT** Facile da pulire: Il calcare viene eliminato semplicemente dagli ugelli elastici in silicone.

**ES** Fácil aseo: La cal se puede retirar sencillamente frotando con los dedos de las toberas elásticas de silicona.

**NL** Eenvoudig schoon: Kalk kan eenvoudig van de noppen worden gewreven.

**DK** Enkel rengøring: Det er let at fjerne kalkaflejring fra stråledyserne.

**PT** Simplesmente limpo: o calcário pode ser simplesmente retirado das saliências através de fricção.

**PL** Po prostu czysto: Pęczki można całkiem łatwo oczyścić z kamienia.

**CS** Jednoduše čistě: Vapenné usazeniny můžete z nopků snadno odstranit třením.

**SK** Jednoducho čistý: Vodný kameň sa dá zo štetin celkom ľahko odstrániť.

**ZH** 清洁: 只需要揉搓花洒表面的出水孔即可去除水垢。

**RU** Простота чистки: известь очень легко стирается с утопленных.

**HU** Egyszerűen tisztá: a vízkő egészen könnyen ledörzsölhető a csomókról.

**FI** Yksinkertaisesti puhdas: kalkin voi helposti hieroa irti nypistä.

**SV** Enkelt att göra rent: det är lätt att ta bort kalk från nopporna.

**LT** Paprasta švara: kalkės lengvai nugarandomos nuo kilpos.

**HR** Jednostavno čisto: Kamenac se sasvim lako uklanja s izbočina.

**TR** Sadece temiz: Kireç, düğümlerle kolayca ovalanabilir.

**RO** Pur și simplu curat: Calcarul se îndepărtează ușor de pe noduri prin frecare.

**EL** Απλά τέλεια καθαριότητα: Τα άλκατα μπορούν να αφαιρεθούν με μεγάλη ευκολία από τα στόμια.

**SL** Preprosto čisto: arnenec se z lahkoto podrgne z vozličkov.

**ET** Lihtsalt puhas: lujja saab nappudelt lihtsalt maha hõõruda.

**LV** Vienkārša tīrīšana: kalcis no izvirzījumiem ir viegli norubināms.

**SR** Jednostavno čisto: Kamenac se sasvim lako skida sa izbočina.

**NO** Simpelt ren: Ved å gnikke er det lett å fjerne kalk fra nuppene.

**BG** Просто чисто: Варовикът лесно може да се изтрпа от удебеленията.

**SQ** Thjeshtë dhe pastër. Mbetjet gëlqerore mund të hiqen me fërkim të lehtë.

**AR** إنه سهل التنظيف، حيث يسقط الجير بسهولة شديدة من الأجزاء الناتئة

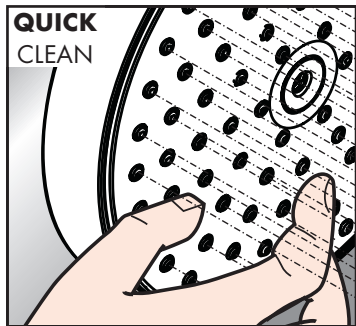

**DE** Reinigungsempfehlung / Garantie / Kontakt

**FR** Recommandation pour le nettoyage / Garanties / Contact

**EN** Cleaning recommendation / Warranty / Contact

**IT** Raccomandazione di pulizia / Garanzia / Contatto

**ES** Recomendaciones para la limpieza / Garantía / Contacto

**NL** Aanbevelingen inzake reiniging / Garantie / Contact

**DK** Rensning, anbefaling / Garanti / Kontakt

**PT** Recomendações de limpeza / Garantia / Contacto

**PL** Zalecenie dotyczący pielęgnacji / Gwarancja / Kontakt

**CS** Doporučení k čistění / Záruka / Kontakt

**SK** Odporúčania pre čistenie / Záruka / Kontakt

**ZH** 清洁指南 / 担保 / 接触

**RU** Рекомендации по очистке / Гарантия / Контакты

**HU** Tisztítási tanácsok / Garancia / érintkezés

**FI** Puhdistussuositus / Takuu / Kosketus

**SV** Rengöringsrekommendationer / Garanti / Kontakt

**LT** Valymo rekomendacijos / Garantija / Kontaktai

**HR** Preporuke za čišćenje / Garancija / Kontakt

**TR** Temizleme önerisi / Garanti / Temas

**RO** Recomandări pentru curățare / Garanție / Contact

**EL** Σύσταση καθαρισμού / Εγγύηση / επαφή

**SL** Priporočilo za čiščenje / Garancija / Kontakt

**ET** Puhastussuovitused / Garantii / Kontakt

**LV** Tīrīšanas ieteikumi / Garantija / Kontakti

**SR** Preporuke za čišćenje / Garancija / Kontakt

**NO** Anbefaling for rengjøring / Garanti / Kontakt

**BG** Препоръка за почистване / Гаранция / Контакт

**SQ** Këshilla rreth pastrimit / Garancia / Kontakt

**KO** 세정시 권장사항 / 품질보증 / 접촉

**AR** توصيات التنظيف / الضمان (الولايات المتحدة الأمريكية) / اتصال



www.hansgrohe.com/cleaning-recommendation

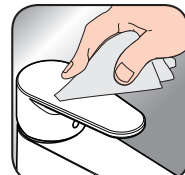

www.hansgrohe.com/cleaning-recommendation



www.hansgrohe.com/cleaning-recommendation



www.hansgrohe.com/cleaning-recommendation

**hansgrohe**

Hansgrohe · Auestraße 5 - 9 · D-77761 Schiltach  
 Telefon +49 (0) 78 36/51-1282 · Telefax +49 (0) 7836/511440  
 E-Mail: info@hansgrohe.com · Internet: www.hansgrohe.com

01/2020  
9.0765.04

**hansgrohe**

**DE** Montageanleitung

**FR** Instructions de montage

**EN** assembly instructions

**IT** Istruzioni per Installazione

**ES** Instrucciones de montaje

**NL** Handleiding

**DK** Monteringsvejledning

**PT** Manual de Instalação

**PL** Instrukcja montażu

**CS** Montážní návod

**SK** Montážny návod

**ZH** 组装说明

**RU** Инструкция по монтажу

**HU** Szerelési útmutató

**FI** Asennusohje

**SV** Monteringsanvisning

**LT** Montavimo instrukcijos

**HR** Uputstva za instalaciju

**TR** Montaj kılavuzu

**RO** Instrucțiuni de montare

**EL** Οδηγία συναρμολόγησης

**SL** Navodila za montažo

**ET** Paigaldusjuhend

**LV** Montāžas instrukcija

**SR** Uputstvo za montažu

**NO** Montasjeveiledning

**BG** Инструкция за употреба

**SQ** Udhëzime rreth montimit

**AR** تعليمات التجميع

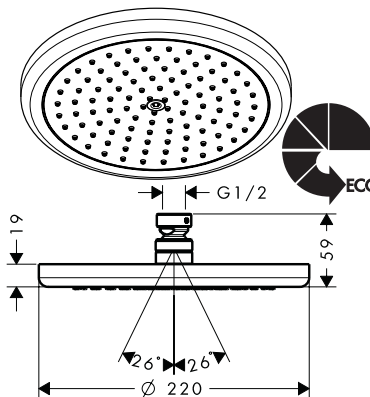

**Croma 220 Air 1jet**  
26465XXX

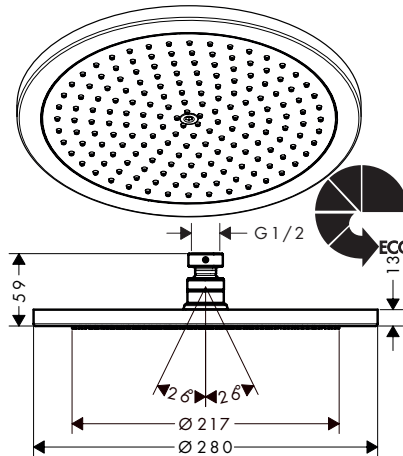

**Croma 280 Air 1jet**  
26221XXX

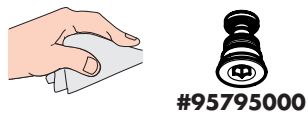
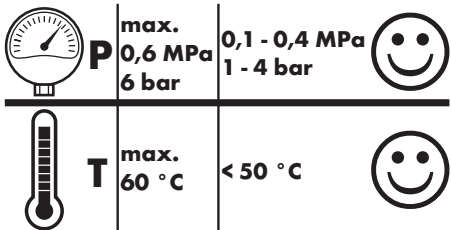

**A - D**

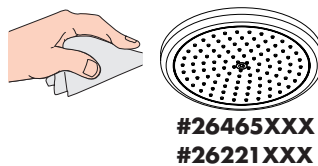

**1 - 6**

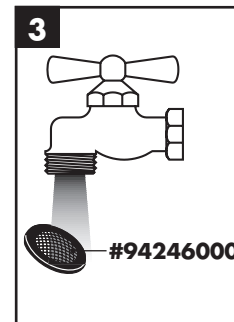
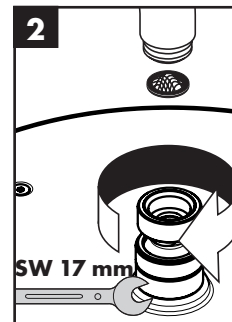
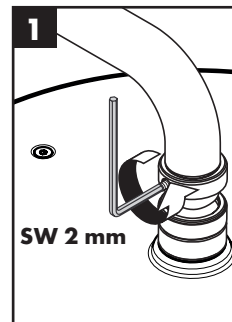

**Croma 220 Air 1jet 26465XXX**

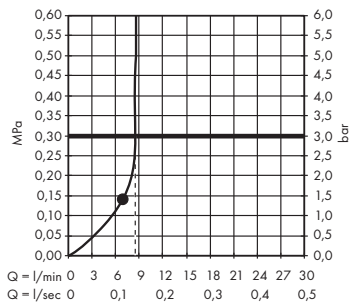

**Croma 280 Air 1jet 26221XXX**

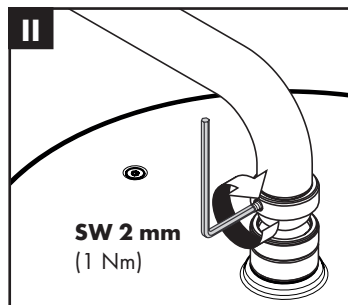
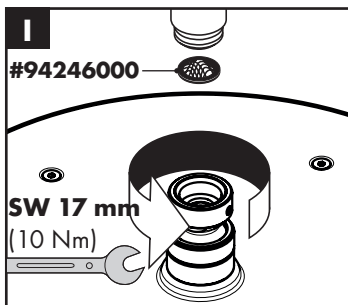
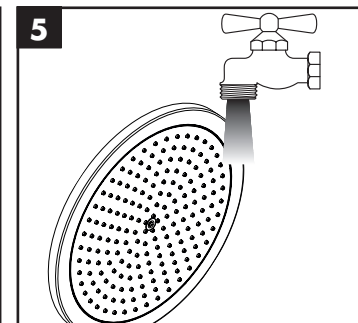
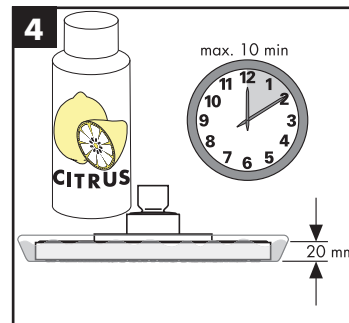
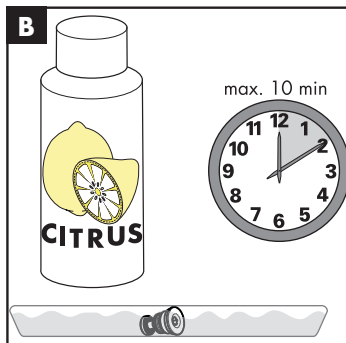
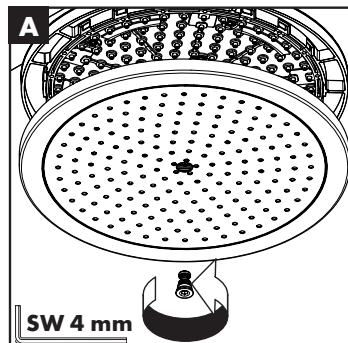
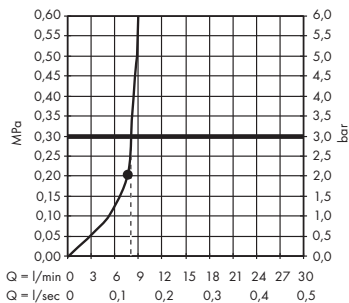

**2**

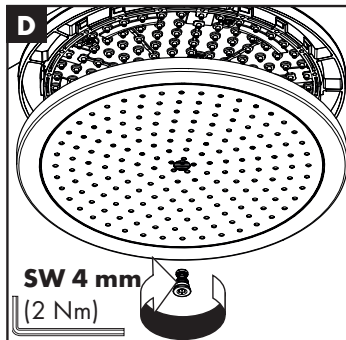
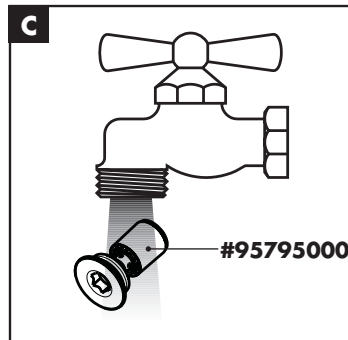

**3**

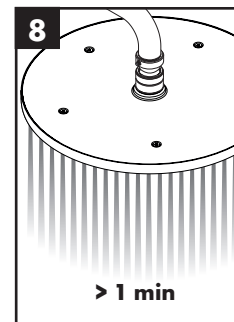
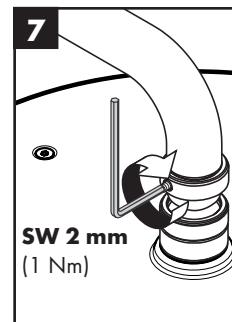
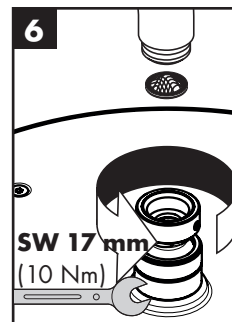

**4**