

hansgrohe

- DE** Gebrauchsanleitung / Montageanleitung
- FR** Mode d'emploi / Instructions de montage
- EN** Instructions for use / assembly instructions
- IT** Istruzioni per l'uso / Istruzioni per Installazione
- ES** Modo de empleo / Instrucciones de montaje
- NL** Gebruiksaanwijzing / Handleiding
- DK** Brugsanvisning / Monteringsvejledning
- PT** Instruções para uso / Manual de Instalação
- PL** Instrukcja obsługi / Instrukcja montażu
- CS** Návod k použití / Montážní návod
- SK** Návod na použitie / Montážny návod
- ZH** 用户手册 / 组装说明
- RU** Руководство пользователя /
Инструкция по монтажу
- FI** Käyttöohje / Asennusohje
- SV** Bruksanvisning / Monteringsanvisning
- LT** Vartotojo instrukcija / Montavimo instrukcijos
- HR** Upute za uporabu / Uputstva za instalaciju
- TR** Kullanım kılavuzu / Montaj kılavuzu
- RO** Manual de utilizare / Instrucțiuni de montare
- EL** Οδηγίες χρήσης / Οδηγία συναρμολόγησης
- SL** Navodilo za uporabo / Navodila za montažo
- ET** Kasutusjuhend / Paigaldusjuhend
- LV** Lietošanas pamācība / Montāžas instrukcija
- SR** Uputstvo za upotrebu / Uputstvo za montažu
- NO** Bruksanvisning / Montasjeveiledning
- BG** Инструкция за употреба /
Ръководство за монтаж
- SQ** Udhëzuesi i përdorimit / Udhëzime rreth montimit
- AR** دليل الاستخدام / تعليمات التجميع
- HU** Használati útmutató / Szerelési útmutató

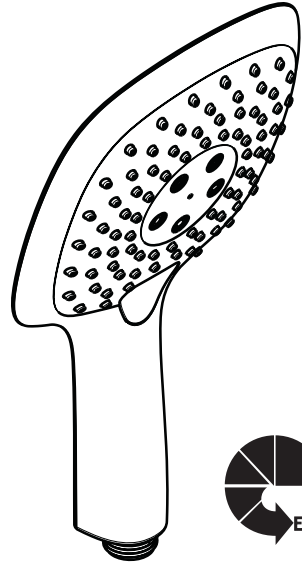

PuraVida 150 3 jet EcoSmart
28567XXX



Ihr Online-Fachhändler für:

hansgrohe

- Kostenlose und individuelle Beratung
- Hochwertige Produkte
- Kostenloser und schneller Versand

- TOP Bewertungen
- Exzelerter Kundenservice
- Über 20 Jahre Erfahrung



E-Mail: info@unidomo.de | Tel.: 04621 - 30 60 89 0 | www.unidomo.de



P max.
0,6 MPa 0,15 - 0,4 MPa (1,1 - 4 bar)
6 bar



T max.
60 °C < 50 °C

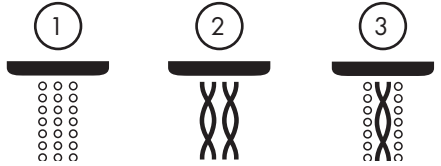
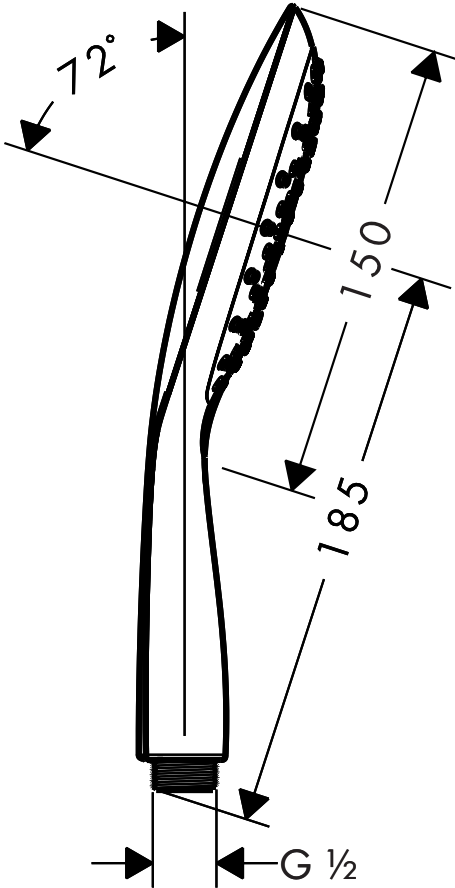
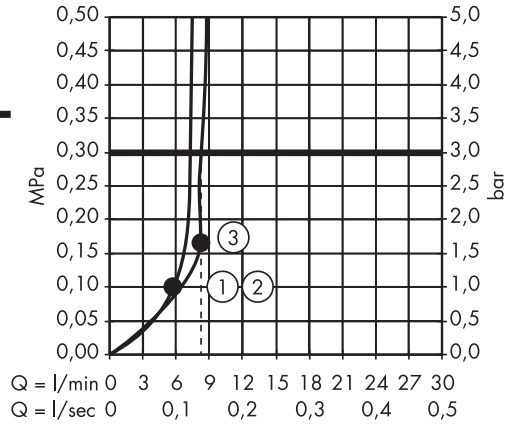

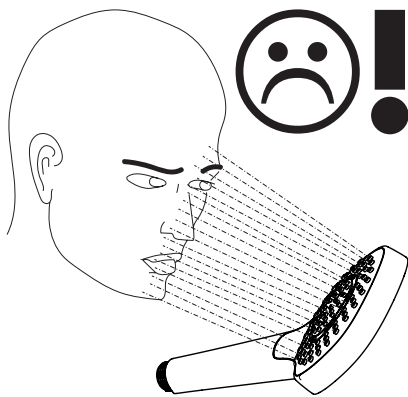
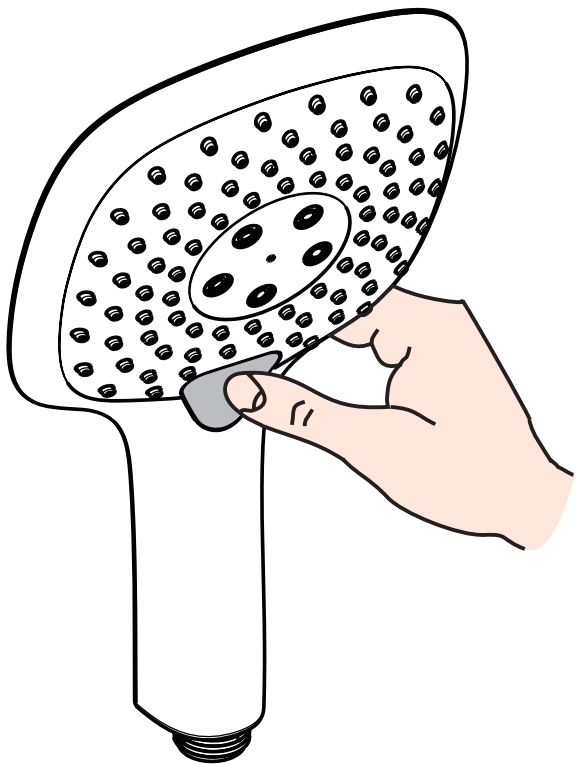
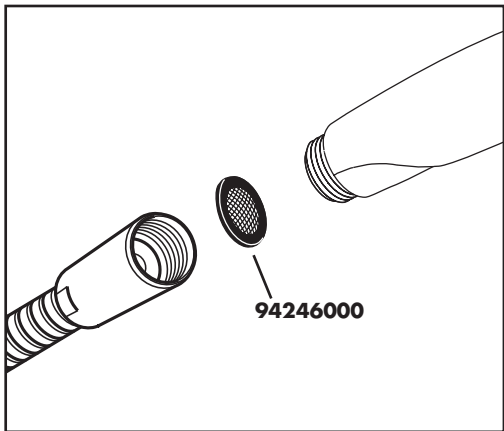

- DE** Reinigungsempfehlung / Garantie / Kontakt
- FR** Recommandation pour le nettoyage / Garanties / Contact
- EN** Cleaning recommendation / Warranty / Contact
- IT** Raccomandazione di pulizia / Garanzia / Contatto
- ES** Recomendaciones para la limpieza / Garantía / Contacto
- NL** Aanbevelingen inzake reiniging / Garantie / Contact
- DK** Rensning, anbefaling / Garanti / Kontakt
- PT** Recomendações de limpeza / Garantia / Contacto
- PL** Zalecenie dotyczące pielęgnacji / Gwarancja / Kontakt
- CS** Doporučení k čištění / Záruka / Kontakt
- SK** Odporúčania pre čistenie / Záruka / Kontakt
- ZH** 清洁指南 / 担保 / 接触
- RU** Рекомендации по очистке / Гарантия / Контакты
- HU** Tisztítási tanácsok / Garancia / érintkezés
- FI** Puhdistussuositus / Takuu / Kosketus
- SV** Rengöringsrekommendationer / Garanti / Contacto
- LT** Valymo rekomendacijos / Garantija / Kontaktai
- HR** Preporuke za čišćenje / Garancija / Kontakt
- TR** Temizleme önerisi / Garanti / Temas
- RO** Recomandări pentru curățare / Garanție / Contact
- EL** Σύσταση καθαρισμού / Εγγύηση / επαφή
- SL** Priporočilo za čiščenje / Garancija / Kontakt
- ET** Puhastussoovitused / Garantii / Kontakt
- LV** Tīrīšanas ieteikumi / Garantija / Kontakti
- SR** Preporuke za čišćenje / Garancija / Kontakt
- NO** Anbefaling for rengjøring / Garanti / Kontakt
- BG** Препоръка за почистване / Гаранция / Контакт
- SQ** Këshilla rreth pastrimit / Garancia / Kontakt
- KO** 세정시 권장사항 / 품질보증 / 접촉
- AR** توصيات التنظيف / الضمان (الولايات المتحدة الأمريكية) / اتصال



[www.hansgrohe.com/
cleaning-recommendation](http://www.hansgrohe.com/cleaning-recommendation)

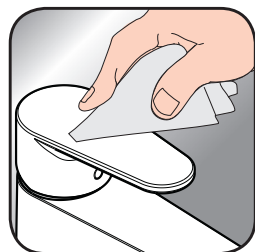

[www.hansgrohe.com/
cleaning-recommendation](http://www.hansgrohe.com/cleaning-recommendation)



[www.hansgrohe.com/
cleaning-recommendation](http://www.hansgrohe.com/cleaning-recommendation)



[www.hansgrohe.com/
cleaning-recommendation](http://www.hansgrohe.com/cleaning-recommendation)

**QUICK
CLEAN**

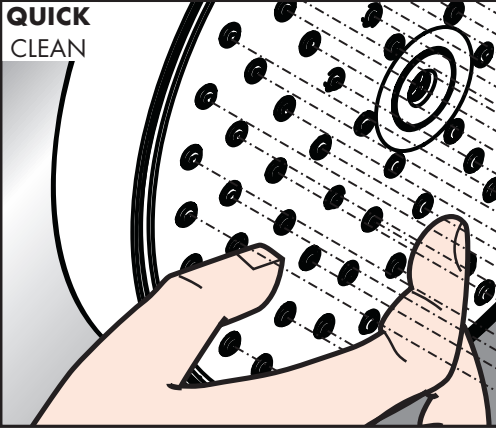

DE Einfach sauber: Kalk lässt sich von den Noppen ganz leicht abrubbeln.

FR La propreté en toute simplicité: les dépôts formés sur les buses élastiques en silicone s'éliminent par un simple passage de la main.

EN Just clean: simply rub over the spray nozzles to remove lime scale.

IT Facile da pulire: Il calcare viene eliminato semplicemente dagli ugelli elastici in silicone.

ES Fácil asear: La cal se puede retirar sencillamente frotando con los dedos de las toberas elásticas de silicona.

NL Eenvoudig schoon: Kalk kan eenvoudig van de noppen worden gewreven.

DK Enkel rengøring: Det er let at fjerne kalkaflejringer fra stråledyserne.

PT Simplesmente limpo: o calcário pode ser simplesmente retirado das saliências através de fricção.

PL Po prostu czysto: Pęczki można całkiem łatwo oczyścić z kamienia.

CS Jednoduše čistě: Vapenné usazeniny můžete z noplek snadno odstranit oříením.

SK Jednoducho čistý: Vodný kameň sa dá zo štetín celkom ľahko odstrániť.

ZH 清洁: 只需要揉搓花洒表面的出水孔即可去除水垢。

RU Простота чистки: известь очень легко стирается с утолщений.

HU Egyszerűen tiszta: a vízkő egészen könnyen ledörzsölhető a csomókról.

FI Yksinkertaisesti puhdas: kalkin voi helposti hieroa irti nyyistä.

SV Enkelt att göra rent: det är lätt att ta bort kalk från popporna.

LT Paprasta švara: kalkės lengvai nugrandamos nuo kilpos.

HR Jednostavno čisto: Kamenac se sasvim lako uklanja s izbočina.

TR Sadece temiz: Kireç, düğümlemlerle kolayca ovalanabilir.

RO Pur și simplu curat: Calcarul se îndepărtează ușor de pe noduri prin frecare.

EL Απλά τέλεια καθαριότητα: Τα άλατα μπορούν να αφαιρεθούν με μεγάλη ευκολία από τα στόμια.

SL Preprosto čisto: arnenec se z lahkoto podrgne z vozličkov.

ET Lihtsalt puhas: lupja saab nuppuheld lihtsalt maha hõõruda.

LV Vienkārša tīrīšana: kaļķis no izvirzījumiem ir viegli norubināms.

SR Jednostavno čisto: Kamenac se sasvim lako skida sa izbočina.

NO Simpelten ren: Ved å gnikke er det lett å fjerne kalk fra nuppene.

BG Просто чисто: Варовикът лесно може да се изтръси от удебеленията.

SQ Thjeshtë dhe pastër. Mbetjet gëlqerore mund të hiqen me fërkim të lehtë.

AR إنه سهل التنظيف، حيث يسقط الجير بسهولة شديدة من الأجزاء الناتئة

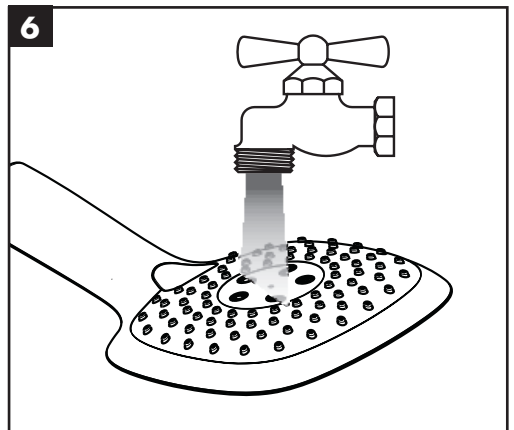
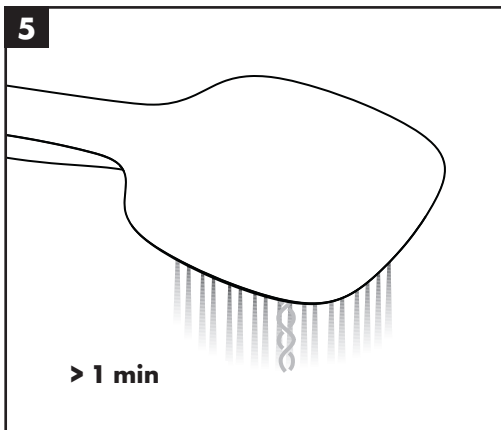
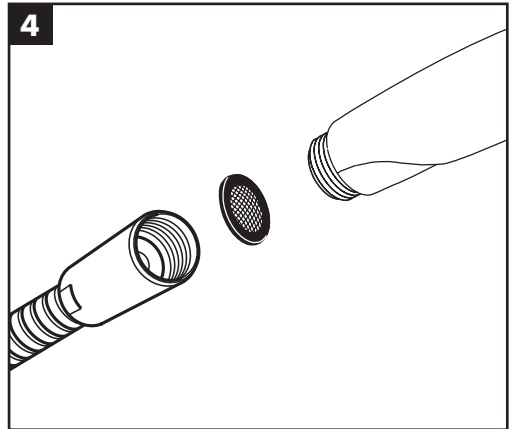
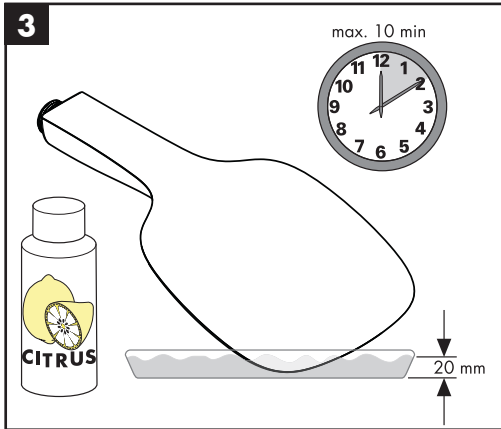
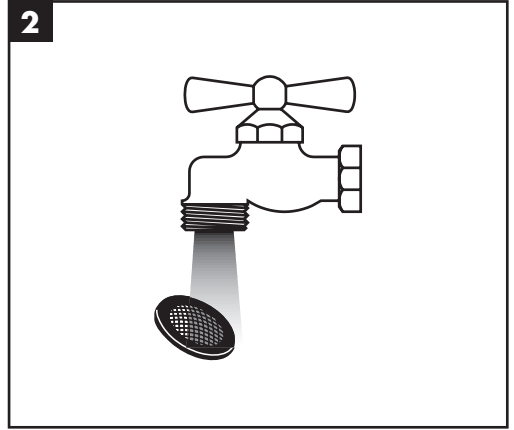
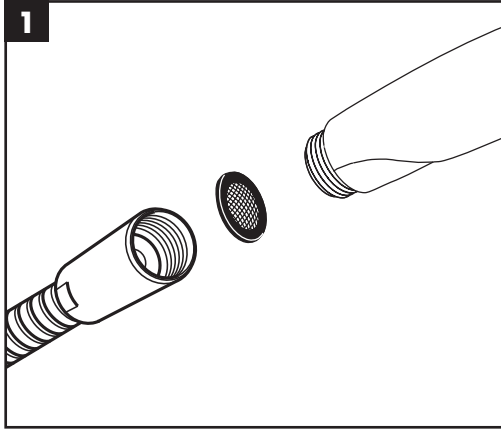

P-IX

DVGW SINTEF NF



ETA



**GODKENDT
TIL DRIKKEVAND**

28567XXX P-IX 19696/IZ BU0498

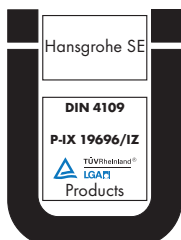

hansgrohe

Hansgrohe · Auestraße 5 · 9 · D-77761 Schiltach · Telefon +49 (0) 78 36/51-1282 · Telefax +49 (0) 7836/511440
E-Mail: info@hansgrohe.com · Internet: www.hansgrohe.com

07/2019
9.01052.01