

DE	Gebrauchsanleitung / Montageanleitung	2
FR	Mode d'emploi / Instructions de montage	3
EN	Instructions for use / assembly instructions	4
IT	Istruzioni per l'uso / Istruzioni per Installazione	5
ES	Modo de empleo / Instrucciones de montaje	6
NL	Gebruiksaanwijzing / Handleiding	7
DK	Brugsanvisning / Monteringsvejledning	8
PT	Instruções para uso / Manual de Instalação	9
PL	Instrukcja obsługi / Instrukcja montażu	10
CS	Návod k použití / Montážní návod	11
SK	Návod na použitie / Montážny návod	12
ZH	用户手册 / 组装说明	13
RU	Руководство пользователя / Инструкция по монтажу	14
HU	Használati útmutató / Szerelési útmutató	15
FI	Käyttöohje / Asennusohje	16
SV	Brugsanvisning / Monteringsanvisning	17
LT	Vartotojo instrukcija / Montavimo instrukcijos	18
HR	Upute za uporabu / Uputstva za instalaciju	19
TR	Kullanım kılavuzu / Montaj kılavuzu	20
RO	Manual de utilizare / Instrucțiuni de montare	21
EL	Οδηγίες χρήσης / Οδηγία συναρμολόγησης	22
SL	Navodilo za uporabo / Navodila za montažo	23
ET	Kasutusjuhend / Paigaldusjuhend	24
LV	Lietošanas pamācība / Montāžas instrukcija	25
SR	Uputstvo za upotrebu / Uputstvo za montažu	26
NO	Brugsanvisning / Montasjeveiledning	27
BG	Инструкция за употреба / Инструкция за употреба	28
SQ	Udhëzuesi i përdorimit / Udhëzime rreth montimit	29
AR	دليل الاستخدام / تعليمات التجميع	30

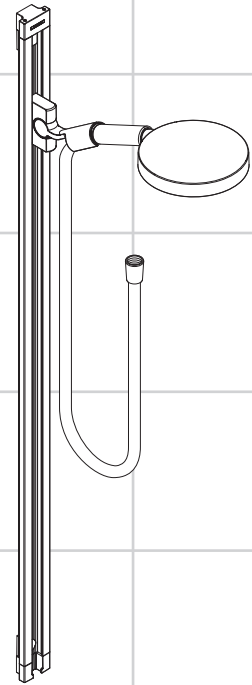

Raindance Unica'S

27636000 / 27637000

Raindance Unica'S Set

27893000 / 27638000

27658000



Ihr Online-Fachhändler für:

hansgrohe

- Kostenlose und individuelle Beratung
- Hochwertige Produkte
- Kostenloser und schneller Versand







- TOP Bewertungen
- Exzelerter Kundenservice
- Über 20 Jahre Erfahrung



E-Mail: info@unidomo.de | Tel.: 04621 - 30 60 89 0 | www.unidomo.de



Sicherheitshinweise

-  Bei der Montage müssen zur Vermeidung von Quetsch- und Schnittverletzungen Handschuhe getragen werden.
-  Kinder, sowie Erwachsene mit körperlichen, geistigen und / oder sensorischen Einschränkungen dürfen nicht unbeaufsichtigt das Duschsystem benutzen. Personen die unter Alkohol- oder Drogeneinfluss stehen, dürfen das Duschsystem nicht benutzen.
-  Der Kontakt der Brausestrahlen mit empfindlichen Körperstellen (z. B. Augen) muss vermieden werden. Es muss ein ausreichender Abstand zwischen Brause und Körper eingehalten werden.
-  Das Produkt darf nicht als Haltegriff benutzt werden. Es muss ein separater Haltegriff montiert werden.
-  Das Duschsystem darf nur zur Bade-, Hygiene- und Körperreinigungszwecke eingesetzt werden.
-  Brausenschläuche sind nur zum Anschluss von Brausen an Armaturen geeignet. Eine Absperrung nach dem Schlauch in Fließrichtung ist unzulässig!

Montagehinweise

- Die Armatur muss nach den gültigen Normen montiert, gespült und geprüft werden.
- Bei der Montage des Produktes durch qualifiziertes Fachpersonal ist darauf zu achten, dass die Befestigungsfläche im gesamten Bereich der Befestigungsplan ist (keine vorstehenden Fugen oder Fliesenversatz), der Wandaufbau für eine Montage des Produktes geeignet ist und keine Schwachstellen aufweist. Die beigelegten Schrauben und Dübel sind nur für Beton geeignet. Bei anderen Wandaufbauten sind die Herstellerangaben des Dübelherstellers zu beachten.
- Der beigepackte Filtereinsatz (97708000) muss eingebaut werden, um den Normdurchfluss der Handbrause zu gewährleisten und um Schmutzeinspülungen aus dem Leitungsnetz zu vermeiden. Wird ein größerer Wasserdurchfluss gewünscht, muss anstelle des Filtereinsatzes (97708000) die Siebdichtung (94246000) eingesetzt werden. Schmutzeinspülungen können die Funktion beeinträchtigen und/oder zu Beschädigungen an Funktionsteilen der Handbrause führen, für hieraus ergebende Schäden haftet Hansgrohe nicht.

Montage

27636XXX/27893000/27658000

siehe Seite 34



- Die Brausestange muss spannungsfrei montiert werden!
- Optimale Funktion nur in Verbindung mit Hansgrohe Handbrausen und Hansgrohe Brausenschläuchen garantiert.

Technische Daten

Betriebsdruck:	max. 0,6 MPa
Empfohlener Betriebsdruck: (1 MPa = 10 bar = 147 PSI)	0,1 - 0,4 MPa
Heißwassertemperatur:	max. 60 °C

Symbolerklärung



Kein essigsäurehaltiges Silikon verwenden!



Durch die Exzenterbuche können Bohrtoleranzen ausgeglichen werden. (siehe Seite 35 + 37)



Maße (siehe Seite 31 - 33)



Durchflussdiagramm
(siehe Seite 32)



Bedienung (siehe Seite 39 - 40)



Reinigung (siehe Seite 41) und
beiliegende Broschüre



Serviceteile (siehe Seite 42)

Sonderzubehör

Eckmontageset (28694000) nicht im Lieferumfang enthalten



Prüfzeichen (siehe Seite 43)







Montage

27637000/27638000

siehe Seite 36



Consignes de sécurité

-  Lors du montage, porter des gants de protection pour éviter toute blessure par écrasement ou coupure.
-  Il est interdit aux enfants ainsi qu'aux adultes ayant des insuffisances physiques, psychiques et/ou motoriques d'utiliser la douche sans surveillance. De même, il est interdit à des personnes sous influence d'alcool ou de drogues d'utiliser la douche.
-  Éviter le contact du jet de la douchette avec les parties sensibles du corps (telles par ex. que les yeux). Veiller à respecter un écart suffisant entre la douchette et le corps
-  Le produit ne doit pas servir de poignée. Monter pour cela une poignée séparée.
-  Le système de douche ne doit servir qu'à se laver et à assurer l'hygiène corporelle.
-  Les flexibles de douche ne doivent être utilisés que pour le raccordement d'une douche à main à un robinet. Le montage d'un système d'arrêt après le flexible, en direction du courant d'eau est strictement interdit.

Instructions pour le montage

- La robinetterie doit être installée, rincée et contrôlée conformément aux normes valables.
- Lors du montage du produit par un ouvrier qualifié, il faut faire attention à ce que la surface de fixation soit plane sur toute son étendue (aucun dépassement de joint ni de carrelage), que la construction de la paroi soit adaptée à l'installation du produit et surtout ne présente aucun point faible. Les vis et les chevilles fournies sont uniquement appropriées au béton. Pour les autres constructions, il faudra tenir compte des préconisations du fabricant de cheville.
- L'élément-filtre (97708000) , pièce jointe, doit être installé pour garantir le débit normalisé et pour éviter l'infiltration d'impuretés venant du réseau. Si l'on désire un débit plus important, il faut remplacer l'élément-filtre (97708000) par le joint-filtre (94246000). L'infiltration d'impuretés peut réduire ou détériorer le fonctionnement de la douchette, Hansgrohe ne se porte pas garant pour les dommages en résultant.

- La barre de douche doit être montée sans aucune tension!
- Un fonctionnement optimal est seulement garanti en combinaison avec des douches à main et des flexibles Hansgrohe.

Informations techniques

Pression de service autorisée:	max. 0,6 MPa
Pression de service conseillée: (1 MPa = 10 bar = 147 PSI)	0,1 - 0,4 MPa
Température d'eau chaude:	max. 60 °C

Description du symbole



Ne pas utiliser de silicone contenant de l'acide acétique!



Grâce à l'axe excentrique de réglage on peut rattraper la tolérance de perçage. (voir pages 35 + 37)

Montage

27636XXX/27893000/27658000

voir pages 34



Montage

27637000/27638000







voir pages 36



Classification acoustique et débit (voir pages 43)



Safety Notes

-  Gloves should be worn during installation to prevent crushing and cutting injuries.
-  Children as well as adults with physical, mental and/or sensoric impairments must not use this shower system without proper supervision. Persons under the influence of alcohol or drugs are prohibited from using this shower system.
-  Do not allow the streams of the shower touch sensitive body parts (such as your eyes). An adequate distance must be kept between the shower and you.
-  The product may not be used as a holding handle. A separate handle must be installed.
-  The shower system may only be used for bathing, hygienic and body cleansing purposes.
-  Shower hoses are only suitable for a connection from the shower to the fitting. Never fit a shut-off device between the fitting and the hose.

Installation Instructions

- The fitting must be installed, flushed and tested after the valid norms.
- Where the contractor mounts the product, he should ensure that the entire area of the wall to which the mounting plate is to be fitted, is flat (no projecting joints or tiles sticking out), that the structure of the wall is suitable for the installation of the product and has no weak points. The enclosed screws and dowels are only suitable for concrete. For another wall constructions the manufacturer's indications of the dowel manufacturer have to be taken into account.
- The filter insert (97708000) must be used to ensure the standard flow rate and to protect the hand shower against incoming dirt by pipework. Do you want a larger water flow rate, then you must use the filter packing (94246000) instead of the filter insert (97708000). Incoming dirt leads to defects or/and can damage parts of the hand shower; such caused faults voids all liability and guarantee claims.
- The wall bar must be mounted stress relieved!
- Optimal functioning is only guaranteed with the combination of Hansgrohe hand showers and Hansgrohe shower hoses.

Technical Data

Operating pressure:	max. 0,6 MPa
Recommended operating pressure: (1 MPa = 10 bar = 147 PSI)	0,1 - 0,4 MPa
Hot water temperature:	max. 60°C

Symbol description



Do not use silicone containing acetic acid!



With the excentric washer it is possible to equalize tolerance of the drilling. (see page 35 + 37)



Dimensions (see page 31 - 33)



Flow diagram
(see page 32)



Operation (see page 39 - 40)



Cleaning (see page 41) enclosed brochure



Spare parts (see page 42)

Special accessories
corner fitting set (28694000) order as an extra



Test certificate (see page 43)

Assembly

27636XXX/27893000/27658000

see page 34









Assembly

27637000/27638000

see page 36



Indicazioni sulla sicurezza

-  Durante il montaggio, per evitare ferite da schiacciamento e da taglio bisogna indossare guanti protettivi.
-  I bambini e gli adulti affetti da menomazioni fisiche, psichiche e/o sensoriali devono utilizzare il sistema della doccia solo sotto la supervisione di una persona responsabile.
-  Bisogna evitare il contatto fra il getto della doccia e parti del corpo delicate (ad es. gli occhi). Fra il soffione ed il corpo va mantenuta una distanza sufficiente.
-  Il prodotto non deve essere utilizzato come maniglia, questa deve essere montata separatamente.
-  Il sistema doccia deve essere utilizzato esclusivamente per l'igiene del corpo.
-  I flessibili devono essere inseriti solo tra l'uscita dell'acqua e la doccetta. Non deve essere introdotta alcuna prolunga tra il flessibile e l'uscita dell'acqua.

Istruzioni per il montaggio

- La rubinetteria deve essere installata, pulita e testata secondo le istruzioni riportate!
- Quando il personale tecnico specializzato esegue il montaggio del prodotto è necessario assicurarsi che la superficie di fissaggio sia piana in tutta l'area di fissaggio (senza giunti sporgenti o spostamento delle piastrelle), che la struttura della parete sia adatta per il montaggio del prodotto e soprattutto che non ci siano dei punti deboli. Le viti e i tasselli in dotazione sono adatti solo per calcestruzzo. In caso di altre strutture della parete vanno osservate le indicazioni del produttore dei tasselli.
- Il filtro supplementare (97708000) deve essere utilizzato per assicurare il normale flusso dell'acqua e proteggere la doccetta dai depositi di calcare. Se volete un flusso d'acqua maggiore dovete usare il filtro dell'imballaggio(94246000) invece del filtro supplementare(97708000). Lo sporco in entrata può danneggiare le parti della doccetta; questo è motivo di molte lamentele del cliente.
- L'asta murale deve essere montata senza forzature!
- Funzionalità ottimale solamente in combinazione con doccette e flessibili Hansgrohe.

Dati tecnici

Pressione d'uso:	max. 0,6 MPa
Pressione d'uso consigliata: (1 MPa = 10 bar = 147 PSI)	0,1 - 0,4 MPa
Temperatura dell'acqua calda:	max. 60°C

Descrizione simbolo



Non utilizzare silicone contenente acido acetico!



Con la rondella eccentrica è possibile equilibrare tolleranze diverse tra i fori. (vedi pagg. 35 + 37)



Ingombri (vedi pagg. 31 - 33)



Diagramma flusso
(vedi pagg. 32)



Procedura (vedi pagg. 39 - 40)



Pulitura (vedi pagg. 41) e brochure allegata



Parti di ricambio (vedi pagg. 42)

Accessori speciali

set di montaggio ad angolo (28694000)
non contenuto nel volume di fornitura



Segno di verifica (vedi pagg. 43)

Montaggio

27636XXX/27893000/27658000

vedi pagg. 34









Montaggio

27637000/27638000

vedi pagg. 36



Indicaciones de seguridad

-  Durante el montaje deben utilizarse guantes para evitar heridas por aplastamiento o corte.
-  Niños, así como adultos con limitaciones corporales, mentales y/o sensoriales no deben utilizar el sistema de duchas sin vigilancia. Personas que se encuentran bajo el efecto de alcohol o drogas, no deben utilizar el sistema de duchas.
-  Debe evitarse el contacto del chorro del pulverizador con partes sensibles del cuerpo (por ej. ojos). Debe mantenerse una distancia suficiente entre pulverizador y cuerpo.
-  El producto no debe ser utilizado como un elemento de sujeción. Debe montarse un elemento de sujeción separado.
-  El sistema de ducha solo debe ser utilizado para fines de baño, higiene y limpieza corporal.
-  Los flexos deben usarse exclusivamente para la conexión entre grifería y teleducha. Cualquier función de cierre tras el flexo y en la dirección del flujo del agua no está permitida.

Indicaciones para el montaje

- El grifo tiene que ser instalado, probado y testado, según las normas en vigor.
- En el momento del montaje del producto por parte de personal especializado y cualificado se deberá prestar una atención especial a que la superficie de fijación en toda el área de la fijación sea plana (sin juntas que sobresalen ni azulejos desplazados), que la estructura de la pared sea adecuada para un montaje del producto y que, ante todo, no presente puntos débiles. Los tornillos y tacos adjuntos son sólo apropiados para hormigón. En el caso de otras estructuras murales se deberán considerar las indicaciones del fabricante de tacos.
- La inserción del filtro (97708000) debe usarse para asegurar el caudal estandar y para proteger la ducha de la suciedad proveniente de las tuberías. Si se quiere un caudal mayor, se debe usar el paquete de filtro (94246000) en lugar de la inserción de filtro (97708000). La suciedad puede producir defectos y/o puede dañar partes de la cabecera de la ducha. Por dichos defectos o fallos Hansgrohe no se hace responsable.

Montaje

27636XXX/27893000/27658000

ver página 34



- La barra debe ser montada sin presión!
- Sólo se garantiza una función óptima en combinación con teleduchas y flexos de Hansgrohe.

Datos técnicos

Presión en servicio:	max. 0,6 MPa
Presión recomendada en servicio:	0,1 - 0,4 MPa
(1 MPa = 10 bar = 147 PSI)	
Temperatura del agua caliente:	max. 60°C

Descripción de símbolos



No utilizar silicona que contiene ácido acético!



Durante la instalación y mediante la excéntrica se puede corregir la posición de la barra. (ver página 35 + 37)



Dimensiones (ver página 31 - 33)



Diagrama de circulación (ver página 32)



Manejo (ver página 39 - 40)



Limpiar (ver página 41) y folleto anexo



Repuestos (ver página 42)

Opcional

Set de esquina (28694000) no incluido en el suministro



Marca de verificación (ver página 43)





Montaje

27637000/27638000

ver página 36



Veiligheidsinstructies

-  Bij de montage moeten ter voorkoming van kniel- en snijwonden handschoenen worden gedragen.
-  Kinderen en volwassenen met lichamelijke, geestelijke en/of sensorische beperkingen mogen het douchesysteem niet zonder toezicht gebruiken. Personen onder invloed van alcohol of drugs mogen het douchesysteem niet gebruiken.
-  Het contact van de douchestraal met gevoelige lichaamsdelen (bijv. ogen) moet worden voorkomen. Er moet voldoende afstand tussen douche en lichaam aangehouden worden.
-  Het product mag niet als handgreep worden gebruikt. Er moet een aparte handgreep gemonteerd worden.
-  Het douchesysteem mag alleen voor het wassen, hygiënische doeleinden en voor de lichaamreiniging worden gebruikt.
-  De doucheslangen zijn alleen geschikt voor de aansluiting van douches aan kranen. Een versperping ná de doucheslang in de stroomrichting is niet toelaatbaar.

Montage-instructies

- Leidingen doorspoelen volgens Norm. De mengkraan vervolgens monteren en controleren.
- Bij de montage van het produkt door een vakkundige installateur moet men erop letten dat het bevestigingsoppervlak op één oppervlak zit (dus geen opliggende voegen of verspringende tegels), de wand geschikt is voor montage van produkten en zeker geen zwakke plekken bevat. De bijgevoegde schroeven en duvels zijn alleen geschikt voor beton. Bei andere wandsoorten dient u te letten op de voorschriften van de fabrikant van de schroeven en duvels.
- De bijgeleverde filter (97708000) moet ingebouwd worden om de norm doorstroom van de handdouche te garanderen en vuil uit de leidingen tegen te houden. Als er een grotere waterdoorlaat gewenst wordt moet i.p.v. het filter de dichting geplaatst worden. Vuil uit de leidingen kan schade aan de handdouche veroorzaken. Op deze schade geeft Hansgrohe geen garantie.
- De glijstang dient spanningsvrij gemonteerd te worden.

Montage

27636XXX/27893000/27658000

zie blz. 34



- Optimal functioneren gegarandeerd bij combinatie met Hansgrohe handdouche en doucheslang.

Technische gegevens

Werkdruk: max.

max. 0,6 MPa

Aanbevolen werkdruk:

0,1 - 0,4 MPa

(1 MPa = 10 bar = 147 PSI)

Temperatuur warm water:

max. 60°C

Symboolbeschrijving



Gebruik geen zuurhoudende silicone!



Door de excentrische bus kunnen eventuele boorafwijkingen worden hersteld. (zie blz. 35 + 37)



Maten (zie blz. 31 - 33)



Doorstroomdiagram (zie blz. 32)



Bediening (zie blz. 39 - 40)



Reinigen (zie blz. 41) en bijgevoegde brochure



Service onderdelen (zie blz. 42)

Toebehoren

hoekmontageset (28694000) behoort niet tot het leveringspakket



Keurmerk (zie blz. 43)

Montage

27637000/27638000

zie blz. 36



Sikkerhedsanvisninger

- ⚠ Ved monteringen skal der bruges handsker for at undgå kvæstelser og snitsår.
- ⚠ Børn som også voksne med fysiske, mentale og / eller sensoriske begrænsninger må ikke bruge brusersystemet uden opsyn. Personer som er under indflydelse af alkohol eller narkotika må ikke bruge brusersystemet.
- ⚠ Bruserstrålens kontakt med sensitive områder (f.eks. øjne) skal undgås. Der skal være en tilstrækkelig afstand mellem bruseren og kroppen.
- ⚠ Produktet må ikke bruges som håndtag. Der skal monteres et separat håndtag.
- ⚠ Brusersystemet må kun bruges til bade-, hygiejne og rengøringsformål.
- ⚠ Bruserslanger bør kun anvendes i forbindelse med tilslutning mellem brusere og armatur. Det er ikke tilladt at montere en afspærringsventil mellem bruser og slange!

Monteringsanvisninger

- Ifølge gældende regler, skal armaturet monteres, skylles igennem og afprøves.
- Ved montering er det vigtigt at sikre sig, at hele befæstigelsesfladen er plan (ingen ujævne fuger eller fliser), samt at væggen er egnet til montering af produktet og specielt, at væggen ikke har nogen svage punkter. De medfølgende skruer og dübler er kun egnet til beton. Ved anden vægopbygning bør producenten af dübler kontaktes for nærmere information.
- Den vedlagte filterindsats (97708000) skal monteres for at sikre en normal vandgennemstrømning og for at forhindre at der kommer smuds i håndbruseren fra rørsystemet. Ønskes en større vandgennemstrømning skal filterindsatsen (97708000) erstattes med en smudsfangsi (94246000). Snavs der er kommet ind i håndbruseren kan skade funktionsdelene i håndbruseren, og Hansgrohes garanti gælder ikke for skader der er opstået på denne måde.
- Undgå at spænde gliderstangen for hårdt!
- Optimal funktion garanteres for anvendelse i forbindelse med Hansgrohe håndbrusere og Hansgrohe bruseslanger.

Tekniske data

Driftstryk:	max. 0,6 MPa
Anbefalet driftstryk: (1 MPa = 10 bar = 147 PSI)	0,1 - 0,4 MPa
Varmtvandstemperatur:	max. 60°C

Symbolbeskrivelse



Der må ikke benyttes eddikesyreholdig silikone!



Ved hjælp af den excentriske bøsning kan evt. skævheder i borehullerne udlignes. (se s. 35 + 37)



Målene (se s. 31 - 33)



Doorstroombdiagram
(se s. 32)



Brugsanvisning (se s. 39 - 40)



Rengøring (se s. 41) og vedlagt brochure



Reserve dele (se s. 42)

Specialtilbehør

hjørnemont.sæt (28694000) ikke med i leveringsomfang



Godkendelse (se s. 43)

Montering

27636XXX/27893000/27658000

se s. 34









Montering

27637000/27638000

se s. 36



Avisos de segurança

-  Durante a montagem devem ser utilizadas luvas de protecção, de modo a evitar ferimentos resultantes de entalamentos e de cortes.
-  Crianças e adultos com deficiências motoras, mentais e/ou sensoriais não podem utilizar o sistema de duche sem monitorização. Pessoas que estejam sob a influência de álcool ou drogas não podem utilizar o sistema de duche.
-  Deve-se evitar o contacto dos jactos de água com partes do corpo sensíveis (p. ex. olhos). É necessário manter uma distância suficiente entre o chuveiro e o corpo.
-  O produto não pode ser utilizado como pega de apoio. Tem que ser montada uma pega separada.
-  O sistema de duche só pode ser utilizado para fins de higiene pessoal.
-  Os tubos flexíveis são apenas adequados para uma ligação do chuveiro à misturadora. Nunca instale uma válvula de corte entre a misturadora e o tubo flexível.

Avisos de montagem

- A misturadora deve ser instalada, purgada e testada de acordo com as normas em vigor.
- Durante a montagem do produto por técnicos qualificados, deve ter-se em atenção que a superfície de fixação seja plana em toda a área da fixação (sem juntas sobrepostas/salientes ou ladrilhos deslocados), que o dispositivo de montagem na parede seja adequado para uma montagem na parede e que este não apresente nenhuns pontos fracos. Os parafusos e buchas incluídos no volume de fornecimento são apenas adequados para betão. Para outros métodos de montagem na parede devem ser respeitadas as indicações do fabricante das buchas.
- O filtro de inserção (97708000) deve ser utilizado para assegurar um caudal standart e para proteger o chuveiro de mão de areias e resíduos provenientes da tubagem. Se quiser um caudal maior, deve usar o filtro de junção (94246000) em vez do filtro de inserção (97708000). Resíduos e areias podem danificar componentes ou provocar o mau funcionamento do chuveiro; as avarias assim provocadas anulam a responsabilidade e garantia Hansgrohe.

Montagem

27636XXX/27893000/27658000

ver página 34



- A barra deve ser montada sem pressão!
- O bom funcionamento é apenas garantido em combinação com chuveiros de mão e tubos flexíveis Hansgrohe.

Dados Técnicos

Pressão de funcionamento:	max. 0,6 MPa
Pressão de func. recomendada: (1 MPa = 10 bar = 147 PSI)	0,1 - 0,4 MPa
Temperatura da água quente:	max. 60°C

Descrição do símbolo



Não utilizar silicone que contenha ácido acético!



Com o encaixe excêntrico é possível compensar a tolerância da furação. (ver página 35 + 37)



Medidas (ver página 31 - 33)



Fluxograma
(ver página 32)



Funcionamento (ver página 39 - 40)



Limpeza (ver página 41) e brochura em anexo



Peças de substituição
(ver página 42)



Acessórios especiais

Adaptador de canto (28694000) não incluído no volume de fornecimento

Marca de controlo

(ver página 43)







Montagem

27637000/27638000

ver página 36



Wskazówki bezpieczeństwa

-  Aby uniknąć zranień, takich jak zgniecenia czy przecięcia, podczas montażu należy nosić rękawice.
-  Zarówno dzieci, jak i dorośli z fizycznymi, psychicznymi i/lub sensorycznymi ograniczeniami nie mogą korzystać z prysznica bez opieki. Osoby znajdujące się pod wpływem alkoholu lub narkotyków nie mogą korzystać z prysznica.
-  Należy unikać kontaktu strumienia wyphywającego z głowicy z wrażliwymi częściami ciała (np. oczami). Należy zachowywać odpowiednią odległość pomiędzy głowicą a ciałem.
-  Produktu nie wolno używać jako uchwytu do trzymania się. Należy zamontować osobny uchwyt.
-  Prysznic może być używany tylko w celach kąpieli, higieny i utrzymania czystości ciała.
-  Wężę prysznicowe przeznaczone są do podłączenia tylko z armaturą. Blokada za wężem w kierunku przepływu jest niedopuszczalna.

Wskazówki montażowe

- Armatura musi być zamontowana, przepłukana i wypróbowana według obowiązujących norm.
- Przy montażu produktu przez wykwalifikowany personel fachowy należy zważać na to, by powierzchnia mocowania na całym obszarze mocowania była równa (by nie było szczelin wzgl. wzajemnie przesuniętych płytek), rodzaj ściany nadawał się do montażu produktu i zwłaszcza, by nie było żadnych słabych stron. Umieszczone w dostawie śruby i kołki rozporowe są przeznaczone tylko do betonu. Przy innych rodzajach montażu ściannowego należy przestrzegać danych producenta kołków rozporowych.
- Należy zamontować znajdującą się w opakowaniu wkładkę filtra (97708000), aby zapewnić przepływowy przepływ przez prysznic ręczny i zapobiec przedostawaniu się zanieczyszczeń z instalacji sieciowej. Jeżeli pożądany jest większy przepływ wody, wówczas należy zamiast wkładki filtra (97708000) użyć uszczelki z siłkiem (94246000). Przedostające się zanieczyszczenia mogą mieć negatywny wpływ na działanie i/lub prowadzić do usterek w działaniu elementów prysznica ręcznego. Za powstałe z tego tytułu szkody firma Hansgrohe nie ponosi odpowiedzialności.

- Drażek prysznica musi być zamontowany bez żadnych naprężeń!
- Optymalne działanie gwarantuje się tylko w odniesieniu do pryszniców ręcznych i wężę prysznicowych Hansgrohe.

Dane techniczne

Ciśnienie robocze:	maks. 0,6 MPa
Zalecane ciśnienie robocze: (1 MPa = 10 bary = 147 PSI)	0,1 - 0,4 MPa
Temperatura wody gorącej:	maks. 60 °C

Opis symbolu



Nie stosować silikonów zawierających kwas octowy!



Za pomocą tulei mimośrodowej można łatwo wyrównać tolerancje otworów. (patrz strona 35 + 37)



Wymiary (patrz strona 31 - 33)



Schemat przepływu
(patrz strona 32)



Obsługa (patrz strona 39 - 40)



Czyszczenie (patrz strona 41) i dołączona broszura



Części serwisowe
(patrz strona 42)



Wyposażenie specjalne
Zestaw do montażu narożnego
(28694000) Nie jest częścią dostawy
Znak jakości (patrz strona 43)

Montaż

27636XXX/27893000/27658000

10

patrz strona 34









Montaż

27637000/27638000

patrz strona 36



Bezpečnostní pokyny

-  Pro zabránění řezným zraněním a pohmožděninám je nutné při montáži nosit rukavice.
-  Děti a dospělá osoba s tělesným, duševním a / nebo smyslovým postižením nesmí sprchový systém používat bez dozoru. Osoby pod vlivem alkoholu nebo drog nesmí sprchový systém používat.
-  Je nutné zabránit kontaktu vodních paprsků sprchy s měkkými částmi těla (např. očima). Je nutné dodržovat dostatečný odstup mezi sprchou a tělem.
-  Produkt nesmí být používán jako madlo. Je nutné namontovat samostatné madlo.
-  Sprchový systém smí být používán pouze ke koupání a za účelem tělesné hygieny.
-  Sprchové hadice jsou vhodné pouze pro napojení sprch na armatury. Řazení uzavíracího ventilu za hadici po směru toku je nepřipustné!

Pokyny k montáži

- Armatura se musí montovat, proplachovat a testovat podle platných norem.
- Při montáži produktu kvalifikovaným odborným personálem je třeba dbát na to, aby upevňovací plochy byly v celém rozsahu upevnění rovné (žádné vyčnívající spáry nebo navzájem přesazené obklady), aby konstrukce stěny byla pro montáž produktu vhodná a zvláště aby v ní nebyla žádná slabá místa. Příložené vruty a hmoždinky jsou vhodné pouze pro beton. Při jiných konstrukčních materiálech stěny je třeba se řídit údaji výrobce hmoždinek.
- Příbalená filtrační vložka (97708000) se musí zabudovat, aby zajistila jmenovitý průtok ruční sprchou a zabránila přístupu nečistot vyplavovaných z potrubí. Pokud se požaduje vyšší průtok, musí se vsadit místo filtrační vložky (97708000) těsnění se sítkem (94246000). Vyplavené nečistoty mohou ovlivnit funkčnost a nebo také vést k poškození funkčních dílů ruční sprchy. Na tyto škody se záruka firmy Hansgrohe nevztahuje.
- Sprchova tyč musí být namontována tak, aby na ni nepůsobilo mechanické napětí.
- Optimální funkce je zaručena pouze s ručními sprchami a sprchovými hadicemi Hansgrohe.

Technické údaje

Provozní tlak:	max. 0,6 MPa
Doporučený provozní tlak: (1 MPa = 10 bar = 147 PSI)	0,1 - 0,4 MPa
Teplota horké vody:	max. 60 °C

Popis symbolů



Nepoužívat silikon s obsahem kyseliny octové!



Excentrickými vložkami je možné vyrovnat tolerance vrtaných otvorů. (viz strana 35 + 37)



Rozměry (viz strana 31 - 33)



Diagram průtoku
(viz strana 32)



Ovládání (viz strana 39 - 40)



Čištění (viz strana 41) a příložená brožura



Servisní díly (viz strana 42)

Zvláštní příslušenství

Sada pro rohovou montáž (28694000) není součástí dodávky



Zkušební značka (viz strana 43)

Montáž

27636XXX/27893000/27658000

viz strana 34









Montáž

27637000/27638000

viz strana 36



Bezpečnostné pokyny

-  Pri montáži musíte nosiť rukavice, aby ste predišli pomliaždeninám a rezným poraneniam.
-  Sprchovací systém nesmú bez dozoru používať deti, ako aj dospelé osoby s telesným, duševným a/alebo zmyslovým postihnutím. Sprchovací systém nesmú používať ani osoby, ktoré sú pod vplyvom alkoholu alebo drog.
-  Vyhýbajte sa kontaktu vodného lúča sprchy s citlivými miestami tela (napr. oči). Dodržiavajte dostatočnú vzdialenosť medzi sprchou a telom.
-  Výrobok sa nesmie používať ako držadlo. K tomu účelu sa musí namontovať samostatné držadlo.
-  Sprchovací systém sa smie používať len na kúpanie a telesnú hygienu.
-  Sprchové hadice sú vhodné iba pre napojenie sprch na batérie. Umiestnenie uzatváracieho ventilu za hadicou v smere toku je neprípustne.

Pokyny pre montáž

- Armatúra sa musí montovať, preplachovať a testovať podľa platných noriem.
- Pri montáži produktu kvalifikovaným odborným personálom je nutné dbať na to, aby upevňovacie plochy boli v celom rozsahu upevnenia rovné (žiadne vyčnievajúce škáry alebo navzájom predsadené obklady), aby konštrukcia steny bola pre montáž produktu vhodná a zvlášť aby v nej neboli žiadne slabé miesta. Priložené vruty a hmoždinky sú vhodné len pre betón. Pri iných konštrukčných materiáloch steny je nutné riadiť sa údajmi výrobcu hmoždiniek.
- Pribalená filtračná vložka (97708000) sa musí zabudovať, aby zaistila menovitý prietok ručnou sprchou a zabránila prístupu nečistôt vyplavovaných z potrubia. Pokiaľ sa požaduje vyšší prietok, musí sa vsadiť namiesto filtračnej vložky (97708000) tesnenie so sitkom (94246000). Vyplavené nečistoty môžu ovplyvniť funkčnosť alebo môžu viesť aj k poškodeniu funkčných dielov ručnej sprchy. Na tieto škody sa záruka firmy Hansgrohe nevzťahuje.
- Tyč sprchy musí byť namontovaná tak, aby na ňu neposobilo mechanické napätie.
- Optimálna funkcia je zaručená iba s ručnými sprchami a sprchovými hadicami Hansgrohe.

Montáž

27636XXX/27893000/27658000

12

vid' strana 34



Technické údaje

Prevádzkový tlak:	max. 0,6 MPa
Doporučený prevádzkový tlak: (1 MPa = 10 bar = 147 PSI)	0,1 - 0,4 MPa
Teplota teplej vody:	max. 60°C

Popis symbolov



Nepoužívať silikón s obsahom kyseliny octovej!



Excentrickými vložkami je možné vyrovať toleranciu vŕtaných otvorov. (vid' strana 35 + 37)



Rozmery (vid' strana 31 - 33)



Diagram prietoku
(vid' strana 32)



Obsluha (vid' strana 39 - 40)



Čistenie (vid' strana 41) a priložená brožúra



Servisné diely (vid' strana 42)

Zvláštne príslušenstvo

Rohová montážna sada (28694000) nie je súčasťou dodávky



Osvedčenie o skúške
(vid' strana 43)

Montáž

27637000/27638000

vid' strana 36



安全技巧

- △ 装配时为避免挤压和切割受伤，必须戴上手套。
- △ 不得让儿童和肢体、精神和/或意识有障碍的成人在不受监管的情况下使用淋浴系统。受酒精或毒品影响的人员不得使用淋浴系统。
- △ 必须避免让身体敏感部位（如眼睛）接触到莲蓬头喷水。必须保持莲蓬头与人头之间有足够的距离。
- △ 该产品不得作扶柄使用。必须安装单独的扶柄。
- △ 淋浴系统只允许作为洗浴、卫生和洁身之用。
- △ 淋浴软管只适合从淋浴器连接到管接头。切勿在管接头和软管之间安装截止装置。

安装提示

- 必须按照现行的规定安装，冲洗和测试产品。
- 在安装产品的位置，安装人员必须确保安装面的墙面是平的（没有突出物或瓷砖没有突起），墙体结构适合产品的安装并没有弱点。包装内的膨胀螺丝只适用于混凝土墙体。对于其他墙体结构必须咨询膨胀螺丝生产商的建议。
- 为了防止管道中的脏东西冲入花洒内，与手持花洒包装在一起的滤柱（97708000）必须安装。如果想要更大的出水量，可用滤网（94246000）代替滤柱（97708000）。
- 这些脏东西会影响手持花洒的功能或损坏手持花洒的功能部件，由此引起的损失汉斯格雅公司概不负责。
- 安装墙架时，必须释放应力！
- 只有与汉斯格雅手持花洒和汉斯格雅淋浴器软管组合使用，方担保最佳的功能。

技术参数

工作压强:	最大 0,6 MPa
推荐工作压强:	0,1 - 0,4 MPa
(1 MPa = 10 bar = 147 PSI)	
热水温度:	最大 60° C

符号说明



请勿使用含有乙酸的硅！



用偏心套管可以补偿消除钻孔的偏差。
(参见第页 35 + 37)



大小 (参见第 31 - 33 页)



流量示意图
(参见第页 32)



操作 (参见第 39 - 40 页)



清洗 (参见第页 41) 并附有小手册



备用零件 (参见第 42 页)

选装附件
角安装测试 (28694000) 不在供货范围内



检验标记 (参见第页 43)

安装

27636XXX/27893000/27658000

参见第页 34









安装

27637000/27638000

参见第页 36



Указания по технике безопасности

-  Во время монтажа следует надеть перчатки во избежание прищемления и порезов.
-  Дети, а также взрослые с физическими, умственными и/или сенсорными недостатками должны пользоваться душевой системой только под присмотром. Запрещается пользоваться душевой системой в состоянии алкогольного или наркотического опьянения.
-  Не допускайте попадания струи воды из разбрызгивателя на чувствительные части тела (например, на глаза). Разбрызгиватель следует устанавливать на достаточном расстоянии от тела.
-  Изделие запрещается использовать в качестве рукоятки. Следует устанавливать специальную рукоятку.
-  Душевую систему разрешается использовать только в гигиенических целях для принятия ванны и личной гигиены.
-  Душевые шланги подходят только для подсоединения душей к арматуре. Не устанавливайте дополнительных затворов между шлангом и арматурой!

Указания по монтажу

- Смеситель должен быть смонтирован по действующим нормам и в соответствии с настоящей инструкцией, проверен на герметичность и безупречность работы.
- При монтаже изделия квалифицированным персоналом необходимо следить за тем, чтобы, поверхность крепления была плоской во всей зоне крепления (без выступающих швов или смещения плитки), структура стен подходила для монтажа изделия и, в частности, не имела слабых мест. Прилагаемые винты и дюбели предназначены только для бетона. При других типах стен необходимо соблюдать указания производителей дюбелей.
- Предустановленный фильтр (97708000) предназначен для обеспечения стандартного расхода воды и защиты внутренней части лейки ручного душа от содержащихся в водопроводной воде загрязнений. Если Вы желаете повысить расход воды, Вам необходимо заменить предустановленный фильтр (97708000) на фильтр-сеточку (94246000). Содержащиеся в воде загрязнения

могут попав внутрь лейки привести к повреждению/поломке внутреннего механизма лейки. В этом случае покупатель теряет право на гарантию.

- душевая стойка должна быть закреплена без „перекоса“
- Оптимальное функционирование гарантируется только при использовании в комбинации с ручными душами Hansgrohe и душевыми шлангами Hansgrohe.

Технические данные

Рабочее давление: не более, 0,6 МПа
 Рекомендуемое рабочее давление: 0,1 - 0,4 МПа
 (1 МПа = 10 bar = 147 PSI)
 Температура горячей воды: не более, 60 °C

Описание символов



Не применяйте силикон, содержащий искусственную кислоту.



С помощью соединения-эксцентрика можно установить штангу строго вертикально. (см. стр. 35 + 37)

Монтаж

27636XXX/27893000/27658000

14

см. стр. 34



Монтаж

27637000/27638000

см. стр. 36



Размеры (см. стр. 31 - 33)



Схема потока

(см. стр. 32)



Эксплуатация (см. стр. 39 - 40)



Очистка (см. стр. 41) и прилагаемая брошюра



Комплект (см. стр. 42)









Специальные принадлежности

комплект для углового монтажа (28694000) не включено в объем поставки!

Знак технического контроля (см. стр. 43)



Biztonsági utasítások

-  A szerelésnél a zúródások és vágási sérülések elkerülése érdekében kesztyűt kell viselni.
-  Gyermekek, valamint testileg, szellemileg fogyatékos vagy érzékelésben korlátozott személyek nem használhatják felügyelet nélkül a zuhanyrendszert. Alkohol és kábítószer befolyása alatt álló személyek nem használhatják a zuhanyrendszert.
-  Kerülni kell a zuhansugár érintkezését érzékeny testrészekkel (pl. szemek). Be kell tartani a megfelelő távolságot a zuhanyfej és a test között.
-  A terméket nem szabad kapaszkodónak használni. Ehhez külön kapaszkodót kell felszerelni.
-  A zuhanyrendszert csak fürdéshez, mosakodáshoz és egészségügyi tisztálkodáshoz szabad használni.
-  A zuhancsővezeték kizárólag zuhanyok csaptelepekkel való összekötésére alkalmasak. A zuhancső után (folyásirány szerint) elzárás beszerelése nem engedélyezett!

Szerelési utasítások

- A csaptelepet az érvényben lévő előírásoknak megfelelően kell felszerelni, átöblíteni és ellenőrizni.
- Miközben szakképzett szakember végzi a termék felszerelését, ügyelni kell arra, hogy a rögzítési felületek a rögzítési terület teljes egészén síkok (nincsenek kiálló fugák vagy csempezélek), a fal felépítése alkalmas a termék felszereléséhez, és különösképpen, hogy nincsenek benne gyenge pontok. A mellékelt csavarok és dübelek csak betonhoz alkalmasak. Egyéb falazatoknál figyelembe kell venni a dübelgyártó gyártói utasításait.
- A mellékelt szűrőbetétet (97708000) be kell szerelni, hogy elérjük a kézizuhany norma szerinti átfolyását, valamint, hogy elkerüljük a vezetékes hálózatból származó szennyeződések zuhanyba való bekerülését. Amennyiben nagyobb átfolyási vízmennyiséget szeretnénk elérni, a szűrőbetét (97708000) helyett használjuk a szűrőtömítést (94246000). A vezetékes hálózatból bekerülő szennyeződések gátolhatják a termék működését, és/vagy megrongálhatják a zuhany működő alkatrészeit. Az ebből adódó károkért a Hansgrohe nem felel.

- A zuhanyrudat feszültségmentesen kell felszerelni.
- A megfelelő működést csak Hansgrohe kézizuhanyokkal és Hansgrohe zuhancsővel garantáljuk.

Műszaki adatok

Üzemi nyomás:	max. 0,6 MPa
Ajánlott üzemi nyomás: (1 MPa = 10 bar = 147 PSI)	0,1 - 0,4 MPa
Forróvíz hőmérséklet:	max. 60 °C

Szimbólumok leírása



Ne használjon ecetsavtartalmú szilikon!



Az excenter hüvelynek köszönhetően a fúrási egyenletlenségek kiegyenlíthetőek. (lásd a oldalon 35 + 37)



Méretet (lásd a 31 - 33. oldalon)



Átfolyási diagramm
(lásd a oldalon 32)



Használat (lásd a 39 - 40. oldalon)



Tisztítás (lásd a oldalon 41) és mellékelt brossúrával



Tartozékok (lásd a 42. oldalon)

Egyéb tartozék

Sarokszerelő-készlet (28694000) a szállítási egység nem tartalmazza



Vizsgajel (lásd a oldalon 43)

Szerelés

27636XXX/27893000/27658000

lásd a oldalon 34









Szerelés

27637000/27638000

lásd a oldalon 36



Turvallisuusohjeet

-  Asennuksessa on käytettävä käsineitä puristumien ja viiltojen aiheuttamien tapaturmien estämiseksi.
-  Lapset ja ruumiillisesti, henkisesti ja/tai aistillisesti rajoittuneet aikuiset eivät saa käyttää suihkujärjestelmää ilman valvontaa. Alkoholien tai huumeiden vaikutuksessa olevat henkilöt eivät saa käyttää suihkujärjestelmää.
-  Suihkuveden kontaktia herkkien ruumiinosien (esim. silmien) kanssa on vältettävä. Suihkun ja vartalon välissä on oltava riittävä väli.
-  Tuotetta ei saa käyttää kädensijana. On asennettava erillinen kädensija.
-  Suihkujärjestelmää saa käyttää ainoastaan kylpy-, hygienia- ja puhdistustarkoituksiin.
-  Suihkuletkut soveltuvat vain käsisuihkun liittämiseen armatuureihin. Letkun jälkeen virtausuunnassa oleva sulkuventtiili ei ole sallittua!

Asennusohjeet

- Kaluste on asennettava, huuhdeltava ja tarkastettava voimassa olevien määräysten mukaisesti.
- Kun pätevä ammattihenkilöstö suorittaa tuotteen asennusta, on huomioitava, että kiinnityspinta on koko kiinnityksen alueella tasainen (ei ulkonevia saumoja tai laattojen tasomuutoksia) ja, että seinän rakenne soveltuu tuotteen asentamiseen eikä siinä ole heikkoja kohtia. Mukana olevat kiinnitysruuvit ja kiinnitysankurit soveltuvat betoniin kiinnittämiseen. Kiinnitettäessä tuotetta muihin seinärakenteisiin, noutata kiinnittimien valmistajan ohjeita.
- Käsisuihkun mukana toimitettu suodatinpatruuna (97708000) on asennettava paikalleen, jotta käsisuihkun normaalivirtaus olisi taattuna ja, jotta lian huuhtoutuminen vesijohtoverkostosta käsisuihkuun estyy. Jos halutaan suurempaa vesimäärää, suodatinpatruunan (97708000) tilalle voidaan asentaa sihtiiviste (94246000). Huuhtoutuvat likahiukkaset voivat häiritä suihkun toimintaa tai vahingoittaa toimintaosia, Hansgrohe ei vastaa tästä aiheutuneista vahingoista.
- Suihkutanko on asennettava siten, että se ei jää jännitykseen.
- Optimaalinen toiminta on taattuna vain Hansgrohe käsisuihkuja ja Hansgrohe suihkuletkuja käytettäessä.

Tekniset tiedot

Käyttöpaino: maks. 0,6 MPa
 Suositeltu käyttöpaino: 0,1 - 0,4 MPa
 (1 MPa = 10 bar = 147 PSI)
 Kuuman veden lämpötila: maks. 60 °C

Merkin kuvaus



Älä käytä etikkahappopitoista silikonia!



Poraustoleranssit voidaan tasata epäkeskholkeilla. (katso sivu 35 + 37)



Mitat (katso sivu 31 - 33)



Virtausdiagrammi
(katso sivu 32)



Käyttö (katso sivu 39 - 40)



Puhdistus (katso sivu 41) ja oheinen esite



Varaosat (katso sivu 42)

Erityisvaruste

Nurkka-asennussetti (28694000) ei kuulu toimitukseen



Koestusmerkki (katso sivu 43)

Asennus

27636XXX/27893000/27658000









Asennus

27637000/27638000



Säkerhetsanvisningar

-  Handskar ska bäras under monteringsarbetet så att man kan undvika kläm- och skärskadorgen werden.
-  Barn samt vuxna med fysiska, psykiska eller sensoriska funktionshinder får inte använda duschsystemet ensamma. Personer som är påverkade av alkohol eller droger får inte använda duschsystemet.
-  Undvik att rikta duschstrålarna mot känsliga kroppsdelar (t. ex. ögonen). Det måste finnas ett tillräckligt stort avstånd mellan duschen och kroppen.
-  Produkten får inte användas som handtag. Ett separat handtag måste monteras.
-  Duschsystemet får bara användas till kroppshygien med bad och dusch.
-  Duschslangar är endast avsedda till att ansluta duschar på blandare. Det är inte tillåtet att lägga in en spärr efter slangens och i flödesriktningen!

Monteringsanvisningar

- Armaturen måste installeras, genomspolas och testas enligt gällande föreskrifter.
- När kvalificerad fackpersonal monterar produkten är det viktigt att tänka på att monteringsytan är plan i alla delar av arbetsytan (inga fogar som sticker ut eller klinkerförskjutningar), att väggkonstruktionen passar till montering av produkten samt att den inte har svaga punkter. Medföljande skruvar och plugg är endast avsedda för betong. Vid andra väggkonstruktioner skall anvisningarna från pluggtillverkaren beaktas.
- Filterinsatsen (97708000) som följer med måste monteras om normalflödet hos handduschen ska vara garanterat och för att undvika att smuts spolas in från ledningsnätet. Önskas kraftigare vattenflöde måste silpackningen (94246000) användas istället för filterinsatsen (97708000). Smuts som spolas in kan påverka funktionerna och/eller leda till skador på funktionsdelar i handduschen. Hansgrohe fransäger sig allt ansvar för skador som kan härledas till detta.
- Duschstången måste monteras spänningfritt!
- Optimal funktion garanteras bar tillsammans med Hansgrohe handduschar och Hansgrohe duschslangar.

Tekniska data

Driftstryck:	max. 0,6 MPa
Rek. driftstryck: (1 MPa = 10 bar = 147 PSI)	0,1 - 0,4 MPa
Varmvattentemperatur:	max. 60°C

Simbolio aprašymas



Använd inte silikon som innehåller ättiksyra!



Borrtoleranser kan utjämnas genom excenterhylsan. (se sidan 35 + 37)



Måtten (se sidan 31 - 33)



Pralaidumo diagrama
(se sidan 32)



Hantering (se sidan 39 - 40)



Rengöring (se sidan 41) och medföljande broschyr



Reservdelar (se sidan 42)

Specialtillbehör

Hörnmonteringsset (28694000) medföljer ej leveransen



Testsigill (se sidan 43)







Montering
27636XXX/27893000/27658000
se sidan 34



Montering
27637000/27638000
se sidan 36



Saugumo technikos nurodymai

-  Apsaugai nuo užspaudimo ir įsijovimo montavimo metu mūvėkite pirštines.
-  Dušo sistema uždrausta naudotis vaikams, taip pat suaugusiems su fizine, dvasine negale ir (arba) sensorikos sutrikimais. Dušo sistema taip pat uždrausta naudotis asmenims, apsvaigusiems nuo alkoholio arba narkotikų.
-  Būtina vengti dušo vandens srovės kontakto su jautriomis kūno vietomis (pvz., akimis). Todėl būtina laikytis tinkamo atstumo nuo dušo.
-  Gaminys neturi būti naudojamas kaip rankena. Rankena montuojama atskirai.
-  Dušo sistema turi būti naudojama tik kūno higienai ir švarai palaikyti.
-  Dušo žarnos yra pritaikytos tik prijungti dušo galvutę prie vandens maišytuvo. Negalima montuoti vandens uždarymo mechanizmo tarp maišytuvo ir žarnos.

Montavimo instrukcija

- Maišytuvą privalo būti montuojamas ir išbandomas pagal veikiančias normas ir šią instrukciją.
- Montuojant produktą, specialistas privalo įsitikinti, kad sienos plotas, prie kurio dedama montavimo plokštė, yra lygus (jokių plytelių ar kitų nelygumų), kad sienos struktūra yra pritaikyta produkto montavimui ir neturi jokių silpnų vietų. Pakuotėje esantys varžtai ir kaiščiai yra skirti tik betonui. Esant kitokiai sienai, varžtus ir kaiščius reikia rinktis pagal paskirtį.
- Filtras (97708000), kuris yra rankų dušas pakuotėje, privalo būti įstatytas, kad būtų garantuota vandens pralaidumo norma ir apsauga nuo nešvarumų. Jei reikia didesnio vandens pralaidumo, vietoje filtro (97708000) įstatykite sietelį (94246000). Nešvarumai gali pakenkti rankų dušas funkcionalumui ir (arba) sugadinti rankų dušas funkcines dalis. Tokiu atveju „Hansgrohe“ atsakomybės neprisiima.
- Montuojant dušo stovą, būtina varžtus prisukti lengvai ir neperveržti!
- Optimalus funkcionavimas yra garantuojamas tik naudojant „Hansgrohe“ rankų dušus su „Hansgrohe“ dušo žarnomis.

Techniniai duomenys

Darbinis slėgis: ne daugiau kaip 0,6 MPa
 Rekomenduojamas slėgis: 0,1 - 0,4 MPa
 (1 MPa = 10 barų = 147 PSI)
 Karšto vandens temperatūra: ne daugiau kaip 60°C

Simbolio aprašymas



Nenaudokite silikono, kurio sudėtyje yra acto rūgšties!



Ekscentrinės jungties pagalba galima išlyginti išgręžtų angų nuokrypį. (žr. psl. 35 + 37)



Išmatavimai (žr. psl. 31 - 33)



Pralaidumo diagrama
(žr. psl. 32)



Eksploatacija (žr. psl. 39 - 40)



Valymas (žr. psl. 41) ir pridedama brošiūra



Atsarginės dalys (žr. psl. 42)

Specialūs priedai

Kampinio montavimo rinkinys (28694000) nėra pridedama



Bandymo pažyma (žr. psl. 43)

Montavimas

27636XXX/27893000/27658000

žr. psl. 34









Montavimas

27637000/27638000

žr. psl. 36



Sigurnosne upute

-  Prilikom montaže se radi sprječavanja prignječenja i posjekotina moraju nositi rukavice.
-  Djeca, kao i tjelesno, mentalno i/ili senzorno hendikepirane odrasle osobe ne smiju se koristiti sustavom tuša bez nadzora. Osobe koje su pod utjecajem alkohola ili droga ne smiju se koristiti sustavom tuša.
-  Mora se izbjegavati kontakt mlaza iz tuša s osjetljivim dijelovima tijela (npr. očima). Tijelo korisnika mora biti dovoljno udaljeno od tuša.
-  Proizvod ne smije služiti za pridržavanje. U tu se svrhu mora postaviti zaseban rukohvat.
-  Sustav tuša se smije primjenjivati samo za kupanje, tuširanje i osobnu higijenu.
-  Crijeva tuša prikladna su jedino za spajanje tuševa na armature. Nije dopušteno zatvaranje crijeva u smjeru protoka vode!

Upute za montažu

- Cijevi moraju biti postavljene, isprane i testirane prema važećim normama.
- Kada proizvod montira kvalificirano stručno osoblje treba paziti da čitava površina na koju se učvršćuje bude ravna (bez istaknutih fuga ili krivljenja pločica), da je zidna konstrukcija primjerena montaži proizvoda te osobito da nema slabih mjesta. Priloženi vijci i moždanici prikladni su samo za beton. Kod drugih zidnih nadgradnji treba obratiti pažnju na navode proizvođača moždanika.
- Filter (97708000) potrebno je ugraditi kako bi se regulirao protok vode i smanjio prolazak prljavštine. Ako želite jači protok vode umjesto filtera ugradite rešetku (94246000). Za eventualna oštećenja uzrokovana prljavštinom proizvođač Hansgrohe nije odgovoran.
- Šipku tuša ne instalirajte pod naponom!
- Optimalno funkcioniranje zajamčeno je jedino u kombinaciji sa Hansgrohe ručnim tuševima i Hansgrohe crijevom za tuš.

Tehnički podatci

Najveći dopušteni tlak:	tlak 0,6 MPa
Preporučeni tlak:	0,1 - 0,4 MPa
(1 MPa = 10 bar = 147 PSI)	
Temperatura vruće vode:	tlak 60 °C

Opis simbola



Nemojte koristiti silikon koji sadrži octenu kiselinu!



Pomoću ekscentara mogu se podesiti tolerancije provrta. (pogledaj stranicu 35 + 37)



Mjere (pogledaj stranicu 31 - 33)



Dijagram protoka
(pogledaj stranicu 32)



Upotreba (pogledaj stranicu 39 - 40)



Čišćenje (pogledaj stranicu 41) i priložena brošura



Rezervni dijelovi (pogledaj stranicu 42)

Posebni pribor

garnitura za kutnu montažu (28694000)
Nije sadržano u isporuci!

Oznaka testiranja (pogledaj stranicu 43)



Sastavljanje

27636XXX/27893000/27658000

pogledaj stranicu 34



Sastavljanje

27637000/27638000

pogledaj stranicu 36



! Güvenlik uyarıları

- ⚠ Montaj esnasında ezilme ve kesilme gibi yaralanmaları önlemek için eldiven kullanılmalıdır.
- ⚠ Bedensel, ruhsal ve/veya sensörük engelli çocuk ve yetişkinler gözetimsiz olarak duş sistemini kullanmamalıdır. Alkol veya uyuşturucu etkisinde olanlar duş sistemini kullanmamalıdır.
- ⚠ Püskürtme başlıklarının hassas organlara teması (örn. gözler) önlenmelidir. Püskürtücü ile beden arasında yeterli mesafe bırakılmalıdır.
- ⚠ Ürün tutma kolu olarak kullanılmamalıdır. Ayrı bir tutma kolu monte edilmelidir.
- ⚠ Duş sistemi yalnızca banyo, hijyen ve beden temizliği amaçları doğrultusunda kullanılabilir.
- ⚠ Sözü geçen duş boruları, duş parçalarını yalnız donanım takımlarına bağlamaya yarar. Hortumun arkasından sonra akış yönünde kesmek yasaktır!

Montaj açıklamaları

- Batarya monte edilmeli, geçerli normlardan sonra akis testi yapılmalıdır.
- Müteahhit, ürünü monteleyeceği yer, yani montaj plakasının monte edileceği duvar alanının tümü düz (herhangi bir eklem yerinin ya da duvar fayansının çıkıntısıyla) engellenmemiş, yapısı ürünü montelemeye uygun bir şekilde ve herhangi zayıf noktası olamamasını sağlamalıdır. Kaplı vidalar ve çubuklar sadece beton için uygundur. Başka duvar yapıları için, imalatçının çubuk imal edenini belirttiği hususlar dikkate alınmalıdır.
- El duşunun norm debisini sağlamak ve şebekeden kir gelmesini önlemek için, ektaki filtre adaptörü (97708000) takılmalıdır. Daha büyük bir su debisi istenirse, filtre adaptörünün (97708000) yerine bir süzgeç contası (94246000) takılmalıdır. Şebekeden gelen kirlere çalışmayı etkileyebilir ve/veya el duşundaki fonksiyon parçalarının zarar görmesine neden olabilir; bu nedenle oluşan hasarlar için Hansgrohe hiçbir sorumluluk üstlenmez.
- Duş çubuğu gerilimsiz şekilde monte edilmelidir!
- Mümkün olduğu kadar iyi işlev, yalnız Hansgrohe elle duş parçaları ve Hansgrohe duş boruları kullanılırsa, garanti edilir.

Teknik bilgiler

İşletme basıncı:	azami 0,6 MPa
Tavsiye edilen işletme basıncı: (1 MPa = 10 bar = 147 PSI)	0,1 - 0,4 MPa
Sıcak su sıcaklığı:	azami 60°C

Simge açıklaması



Asetik asit içeren silikon kullanmayın!



Eksantrik burç ile delik toleransları dengelebilir. (bakınız sayfa 35 + 37)



Ölçüleri (bakınız sayfa 31 - 33)



Akış diyagramı
(bakınız sayfa 32)



Kullanımı (bakınız sayfa 39 - 40)



Temizleme (bakınız sayfa 41) ve birlikte verilen broşür



Yedek Parçalar
(bakınız sayfa 42)



Özel aksesuarlar
Köşe montaj seti (28694000) Teslimat kapsamına dahil değildir
Kontrol işareti (bakınız sayfa 43)

Montajı

27636XXX/27893000/27658000

20

bakınız sayfa 34









Montajı

27637000/27638000

bakınız sayfa 36



Instrucțiuni de siguranță

-  La montare utilizați mănuși pentru evitarea contuziunilor și tăierii mâinilor.
-  Copiii și adulții cu dizabilități corporale, mintale și senzoriale nu pot utiliza sistemul de duș nesupravegheați. De asemenea este interzisă utilizarea sistemului de duș de către persoane, care se află sub influența alcoolului sau a drogurilor.
-  Evitați contactul jetului de apă cu părțile de corp sensibile (de ex. ochii). Țineți dușul la o distanță corespunzătoare de corp.
-  Nu este permisă utilizarea produsului pe post de mâner. este nevoie de montarea unui mâner corespunzător.
-  Sistemul de duș poate fi utilizat doar pentru spălarea, menținerea igienei și curățarea corpului.
-  Furtunul de duș poate fi utilizat numai pentru conectarea telefonului de duș la baterie. Nu este permisă montarea unui opritor la capătul furtunului!

Instrucțiuni de montare

- Bateria trebuie montată, clătită și verificată conform normelor în vigoare.
- La montarea produsului de către un personal calificat trebuie să fiți atenți ca suprafața, unde se fixează produsul să fie plată pe toată suprafața utilizată (să nu existe rosturi sau faianțe proeminente), peretele să fie adecvat pentru montarea produsului și să nu există zone de rezistență redusă. Șuruburile și diblurile livrate sunt potrivite pentru ziduri de beton. La alte tipuri de zid respectați instrucțiunile producătorului diblului utilizat.
- Montați garnitura de filtru (97708000) livrată cu aparatul pentru asigurarea funcționării corespunzătoare a dușului de mână și pentru evitarea pătrunderii impurităților din rețeaua de apă. Dacă doriți un debit mai mare de apă, montați garnitura sită (94246000) în locul garniturii de filtru (97708000). Impuritățile pătrunse pot influența funcționarea dușului de mână și/sau deteriora componentele acestuia, garanția nu acoperă daunele provocate din această

cauză.

- Întrerupeți alimentarea cu energie electrică pentru montarea consolei de duș.
- Funcționarea optimă este garantată numai când este conectat la duș de mână și furtun de duș marca Hansgrohe.

Date tehnice

Presiune de funcționare:	max. 0,6 MPa
Presiune de funcționare recomandată:	0,1 - 0,4 MPa (1 MPa = 10 bar = 147 PSI)
Temperatura apei calde:	max. 60°C

Descrierea simbolurilor



Nu utilizați silicon cu conținut de acid acetic!



Compensați diferențele de găurit cu ajutorul bușei excentrice. (vezi pag. 35 + 37)



Dimensiuni (vezi pag. 31 - 33)



Diagrama de debit
(vezi pag. 32)



Utilizare (vezi pag. 39 - 40)



Curățare (vezi pag. 41) și broșura alăturată



Piese de schimb (vezi pag. 42)

Accesorii opționale

Set pentru montare pe colț (28694000) nu este inclus în setul livrat



Certificat de testare
(vezi pag. 43)

Montare

27636XXX/27893000/27658000

vezi pag. 34



Montare

27637000/27638000

vezi pag. 36



Υποδειξεις ασφαλείας

- ⚠ Για να αποφύγετε τραυματισμούς κατά τη συναρμολόγηση πρέπει να φοράτε γάντια.
- ⚠ Παιδιά ή ενήλικες με μειωμένες σωματικές, διανοητικές και/ή αισθητήριες ανεπάρκειες δεν επιτρέπεται να χρησιμοποιούν το σύστημα ντους χωρίς επίτηρηση. Άτομα υπό την επήρεια οινοπνεύματος ή ναρκωτικών δεν επιτρέπεται να χρησιμοποιούν σε καμία περίπτωση το
- ⚠ Η επαφή δέσμης νερού του ντους με ευαίσθητες περιοχές του σώματος (π.χ. μάτια) πρέπει να αποφεύγεται. Διατηρείτε επαρκή απόσταση ανάμεσα στο ντους και το σώμα.
- ⚠ Το προϊόν δεν επιτρέπεται να χρησιμοποιείται σαν λαβή στήριξης. Για τον σκοπό αυτό πρέπει να τοποθετηθεί ξεχωριστή λαβή στήριξης.
- ⚠ Το σύστημα ντους επιτρέπεται να χρησιμοποιείται μόνο σαν μέσο λουτρού, υγιεινής και καθαρισμού του σώματος.
- ⚠ Το εύκαμπτο σπирάλ του καταιονιστήρα είναι κατάλληλο μόνο για τη σύνδεση του καταιονιστήρα χειρός με τη βάνα. Δεν επιτρέπεται καμία στρόφιγγα διακοπής μετά το σωλήνα στην κατεύθυνση ροής!

Οδηγίες συναρμολόγησης

- Η μπαταρία πρέπει να τοποθετηθεί, να πλυθεί και να ελεγχθεί με βάση τους ισχύοντες κανόνες υδραυλικής τέχνης
- Κατά τη συναρμολόγηση του προϊόντος από καθαρισμένο και εξειδικευμένο προσωπικό θα πρέπει να δοθεί προσοχή, ώστε η επιφάνεια στερέωσης στη συνολική περιοχή στερέωσης να είναι επίπεδη (να μην υπάρχουν προεξέχοντες αρμοί ή λιθογόμωση πλακιδίων), ώστε η κατασκευή του τοίχου να είναι κατάλληλη για τη συναρμολόγηση του προϊόντος και ώστε η επιφάνεια να μην παρουσιάζει αδύναμα σημεία. Οι συννημένες βίδες και οι στυλισκοί ενδείκνυται μόνο για σκυρόδεμα. Σε άλλες επίτοιχες κατασκευές θα πρέπει να δοθεί προσοχή στα δεδομένα του Κατασκευαστή των στυλισκών.
- Η συνοδευτική προσθήκη φίλτρου (97708000) πρέπει να εγκατασταθεί, προκειμένου να διασφαλίσει την κανονική ροή του καταιονιστήρα χειρός και να αποτρέψει την είσοδο ρύπων από το δίκτυο ύδρευσης. Εάν είναι επιθυμητή μία μεγαλύτερη ροή νερού, θα πρέπει, στη θέση της προσθήκης φίλτρου (97708000) να τοποθετηθεί το στεγανοποιητικό παρέμβυσμα

Συναρμολόγηση

27636XXX/27893000/27658000

22

βλ. Σελίδα 34



(94246000). Η είσοδος ρύπων μπορεί να επηρεάσει δυσμενώς τη λειτουργία ή/και να προκαλέσει βλάβες στα λειτουργικά σημεία του καταιονιστήρα χειρός, για τις οποίες Ζημιές δεν αναλαμβάνει καμία ευθύνη η εταιρεία Hansgrohe.

- Η ράβδος του καταιονιστήρα θα πρέπει να συναρμολογηθεί με απενεργοποιημένη τάση!
- Εγγύηση βέλτιστης λειτουργίας μόνο σε συνδυασμό με καταιονιστήρα χειρός Hansgrohe και σπирάλ Hansgrohe.

Τεχνικά Χαρακτηριστικά

Λειτουργία πίεσης: έως 0,6 MPa
 Συνιστώμενη λειτουργία πίεσης: 0,1 - 0,4 MPa
 (1 MPa = 10 bar = 147 PSI)
 Θερμοκρασία ζεστού νερού: έως 60 °C

Περιγραφή συμβόλων



Μην χρησιμοποιείτε σιλικόνη που περιέχει οξικό οξύ!



Μέσω του κουτιού του εκκέντρου είναι δυνατή η εξισορρόπηση των ανοχών διάτρησης. (βλ. Σελίδα 35 + 37)



Διαστάσεις (βλ. σελίδα 31 - 33)



Διάγραμμα ροής
(βλ. Σελίδα 32)



Χειρισμός (βλ. σελίδα 39 - 40)



Καθαρισμός (βλ. Σελίδα 41) και συνημμένο φυλλάδιο



Ανταλλακτικά (βλ. σελίδα 42)

Ειδικά αξεσουάρ

Σε γωνιακής συναρμολόγησης (28694000) δεν περιλαμβάνεται στον παραδοτέο εξοπλισμό

Σήμα ελέγχου (βλ. Σελίδα 43)









Συναρμολόγηση

27637000/27638000

βλ. Σελίδα 36



Varnostna opozorila

-  Pri montaži je treba nositi rokavice, da se prepreči poškodbe zaradi zmečkanja ali urezov.
-  Otroci kot tudi odrasle osebe z omejenimi telesnimi, duševnimi in/ali senzoričnimi sposobnostmi ne smejo nenadzorovano uporabljati sistema za prhanje. Osebe, ki so pod vplivom alkohola ali drog, sistema za prhanje ne smejo uporabljati.
-  Éviter le contact du jet de la douchette avec les parties sensibles du corps (telles par ex. que les yeux). Veiller à respecter un écart suffisant entre la douchette et le corps
-  Proizvoda ne smete uporabljati kot držalnega ročaja. V ta namen je treba montirati poseben ročaj.
-  Sistem za prhanje se sme uporabljati le z namenom umivanja, vzdrževanja higiene in telesne nege.
-  Gibke cevi za prho so primerne le za povezavo prhe in armature. Naprave za zapiranje pretoka vode nikoli ne nameščajte med armaturo in cev.

Navodila za montažo

- Armaturo je potrebno montirati, splakniti in testirati v skladu z veljavnimi predpisi.
- Kamorkoli bo pogodbenik namestil izdelek, mora poskrbeti, da je celotno območje stene na katero bo plošča nameščena ravno (brez štrlečih fug ali robov ploščic), ter da je struktura stene primerna za namestitvev in je brez šibkih točk. Priloženi vijaki in ležaji so primerni le za beton. Za ostale zidne konstrukcije je potrebno upoštevati proizvajalčeva navodila.
- Priloženi filtrirni vložek (97708000) je potrebno vgraditi, da zagotovimo standardni pretok in zaščitimo ročno prho pred umazanijo iz vodovodne napeljave. Če želite večji pretok vode, je namesto filtrirnega vložka (97708000) potrebno vstaviti filtrirno mrežico (94246000). Umazanija lahko okvari ali poškoduje dele ročne prhe. Za tako nastalo škodo Hansgrohe ne odgovarja.
- Zidno palico za prho je potrebno montirati brez napetosti!
- Optimalno delovanje je zagotovljeno le v povezavi z ročnimi prhami Hansgrohe in gibkimi cevmi za prho Hansgrohe.

Tehnični podatki

Delovni tlak:	maks. 0,6 MPa
Priporočeni delovni tlak:	0,1 - 0,4 MPa
(1 MPa = 10 bar = 147 PSI)	
Temperatura tople vode:	maks. 60°C

Opis simbola



Ne smete uporabiti silikona, ki vsebuje očetno kislino!



Z ekscentričnim vodilom lahko izravnate tolerance vrtanja. (glejte stran 35 + 37)



Mere (glejte stran 31 - 33)



Diagram pretoka
(glejte stran 32)



Upravljanje (glejte stran 39 - 40)



Čiščenje (glejte stran 41) in priložena brošura



Rezervni deli (glejte stran 42)



Preskusni znak (glejte stran 43)







Montaža
27636XXX/27893000/27658000
glejte stran 34



Montaža
27637000/27638000
glejte stran 36



Ohutusjuhised

-  Kandke paigaldamisel muljumis- ja löikevigastuste vältimiseks kindaid.
-  Lapsed, samuti kehaliste, vaimsete või tajupiirangutega täiskasvanud ei tohi dušisüsteemi järelvalveta kasutada. Alkoholi või narkootikumide mõju all olevad isikud ei tohi dušisüsteemi kasutada.
-  Duši veejoad ei tohi kokku puutuda tundlike kehaosadega (nt silmad). Jätke duši ja keha vahele piisav vahe.
-  Toodet ei tohi kasutada käepidemena. Paigaldage eraldi käepide.
-  Dušisüsteemi tohib kasutada ainult pesemis-, hügieeni- ja kehapuhastamisesmärkidel.
-  Dušivoolikud sobivad üksnes duši ühendamiseks segistitega. Mingil juhul ei tohi vooliku ja segisti vahele asetada sulgurit.

Paigaldamisjuhised

- Seadmestiku paigaldamine, läbipesu ja kontrollimine peab toimuma vastavalt kehtivatele normidele.
- Toote paigaldamisel peab töövõtja tagama, et kogu seinapind, kuhu paigaldusplaat kinnitatakse, on lame (ükski vuuk ega keraamiline plaat ei ulatu esile), ning et seina konstruktsioon on toote paigaldamiseks sobiv ja sellel puuduvad nõrgad kohad. Kaasasolevad kruvid ja tüüblid sobivad üksnes betoonile. Muude seinakonstruktsioonide puhul tuleb arvesse võtta tüüblitootja esitatud tooteandmeid.
- Käsiduši standardse läbivoolu puhul peab veevärgist tuleva mustuse vastu paigaldama kaasasoleva filtri A. Kui soovite suuremat läbivoolu, peab selle asemel kasutama filtrit 94246000. Filtri 97708000 või 94246000 mittepaigaldamisel käsiduši võib sissetulev mustus funktsioneerimist kahjustada ja/või rikkuda käsiduši detaile. Sellest tulenevate kahjude eest Hansgrohe ei vastuta.
- Dušilift peab olema monteeritud pingevabalt!
- Optimaalne funktsioneerimine on garanteeritud ainult koos Hansgrohe käsidušide ja Hansgrohe dušivoolikutega.

Tehnilised andmed

Töörõhk	maks. 0,6 MPa
Soovitatav töörõhk:	0,1 - 0,4 MPa
(1 MPa = 10 baari = 147 PSI)	
Kuuma vee temperatuur:	maks. 60°C

Sümbolite kirjeldus



Ärge kasutage äädikhapet sisaldavat silikooni!



Ekstsentrilise vaheseibiga saab puurimisel tekkinud erinevusi tasakaalustada. (vt lk 35 + 37)



Mõõtude (vt lk 31 - 33)



Läbivooludiagramm (vt lk 32)



Kasutamine (vt lk 39 - 40)



Puhastamine (vt lk 41) ja kaasasolev brošüür



Varuosad (vt lk 42)

Spetsiaalne lisavarustus

Nurga paigalduskomplekt (28694000) ei sisaldu komplektis



Kontrollsertifikaat (vt lk 43)

Paigaldamine

27636XXX/27893000/27658000

vt lk 34









Paigaldamine

27637000/27638000

vt lk 36



Drošības norādes

-  Montāžas laikā, lai izvairītos no saspiedumiem un iegriezumiem, nepieciešams nēsāt cimdus.
-  Bērni, kā arī pieaugušie ar fiziskiem, garīgiem un / vai sensoriskiem ierobežojumiem nedrīkst lietot šo dušas sistēmu bez uzraudzības. Personas, kas atrodas alkohola vai narkotisko vielu iespaidā, nedrīkst lietot šo dušas sistēmu.
-  Nepieciešams izvairīties no dušas strūkļas tieša kontakta ar jutīgām ķermeņa daļām (piem., acīm). Nepieciešams ievērot pietiekošu attālumu starp dušu un ķermeni.
-  Šo produktu nedrīkst izmantot kā roku balstu. Nepieciešams uzmontēt atsevišķu roku balstu.
-  Šo dušas sistēmu drīkst izmantot tikai, lai mazgātos, higiēnai un ķermeņa tīrīšanai.
-  Dušas šļūtenes ir piemērotas tikai dušas pieslēgšanai pie jāucējkrāna. Nepieļaujama ir noslēgarmatūras pievienošana aiz šļūtenes plūsmas virzienā!

Norādījumi montāžai

- Jaucējkrāns jāmontē, jāskalo un jāpārbauda atbilstoši spēkā esošajām normām.
- Ja izstrādājuma montāžu veic kvalificēti speciālisti, jāseko, lai nostiprināšanas virsma visā nostiprināšanas zonā būtu gluda (šuves un flīzes nav izvirzītas uz āru), lai sienas konstrukcija būtu piemērota izstrādājuma montāžai un būtu pietiekami izturīga. Komplektā esošās skrūves un dibelji ir paredzēti tikai šī izstrādājuma nostiprināšanai. Ja sienas konstrukcija ir citāda, jāievēro dibelju ražotāja norādījumi.
- Lai nodrošinātu rokas dušas normālu ūdens caurplūdi un izvairītos no nefirumu ieskaldošanas no ūdensvada, jāņemot komplektā esošais filtrs (97708000). Ja ir nepieciešamība pēc lielākas ūdens caurplūdes, tad filtra (97708000) vietā jāizmanto sietiņš (94246000). Ieskalotie nefirumi var traucēt dušas funkciju un / vai arī izraisīt rokas dušas funkciju bojājumus, par kuriem Hansgrohe nenes atbildību.
- Dušas stienis jāmontē, to nenoslogojot!
- Optimāla funkcija tiek garantēta tikai kombinācijā ar Hansgrohe rokas dušām un Hansgrohe dušas šļūtenēm.

Tehniskie dati

Darba spiediens: maks. 0,6 MPa
 Ieteicamais darba spiediens: 0,1 - 0,4 MPa
 (1 MPa = 10 bar = 147 PSI)
 Karstā ūdens temperatūra: maks. 60°C

Simbolu nozīme



Neizmantot silikonu, kas satur etiķskābi!



Ar ekscentra bukses palīdzību var izlīdzināt urbuma neprecizitātes. (skat. lpp. 35 + 37)



Izmērus (skat. 31 - 33. lpp.)



Caurplūdes diagramma (skat. lpp. 32)



Lietošana (skat. 39 - 40. lpp.)



Tīrīšana (skat. lpp. 41) un klāt pievienotais buklets



Rezerves daļas (skat. 42. lpp.)

Speciāli aksesuāri

Stūra montāžas komplekts (28694000) komplektā netiek piegādāts



Pārbaudes zīme (skat. lpp. 43)

Montāža

27636XXX/27893000/27658000

skat. lpp. 34









Montāža

27637000/27638000

skat. lpp. 36



Sigurnosne napomene

-  Prilikom montaže se radi sprečavanja prignječenja i posekofina moraju nositi rukavice.
-  Deca, kao i telesno, mentalno i/ili senzorno hendikepirane odrasle osobe ne smeju da koriste sistem tuša bez nadzora. Osobe koje su pod uticajem alkohola ili droga ne smeju da koriste sistem tuša.
-  Mora se izbegavati kontakt mlaza iz tuša sa osetljivim delovima tela (npr. očima). Telo korisnika mora biti na dovoljnom odstojanju od tuša.
-  Proizvod se ne sme koristiti za kao ručka za pridržavanje. U tu svrhu se mora postaviti zaseban rukohvat.
-  Sistem tuša sme da se koristi samo za kupanje, tuširanje i ličnu higijenu.
-  Creva tuša prikladna su jedino za spajanje tuševa na armature. Nije dopušteno blokiranje creva u smeru protoka vode!

Instrukcije za montažu

- Armatura mora biti postavljena, isprana i testirana prema važećim normama.
- Kada proizvod montira kvalifikovano stručno osoblje treba paziti da čitava površina na koju se učvršćuje bude ravna (bez istaknutih fuga ili krivljenja pločica), da je zidna konstrukcija primerena montaži proizvoda, i posebno da nema slabih mesta. Priloženi zavrtnji i tiplovi prikladni su samo za beton. Kod drugih zidnih nadgradnji treba obratiti pažnju na navode proizvođača tiplova.
- Isporučeni umetak filtra (97708000) se mora ugraditi kako bi se regulisao protok vode i smanjio prolazak prljavštine iz vodovoda. Ako želite jači protok vode, umesto filtra (97708000) ugradite mrežastu zaptivku (94246000). Za eventualna oštećenja ili lošije funkcionisanje ručnog tuša uzrokovano prljavštinom, proizvođač Hansgrohe nije odgovoran.
- Šipka tuša se mora tako instalirati da ne bude izložena naprezanju!
- Optimalno funkcionisanje je garantovano jedino u kombinaciji sa Hansgrohe ručnim tuševima i Hansgrohe crevom za tuš.

Tehnički podaci

Radni pritisak:	maks. 0,6 MPa
Preporučeni radni pritisak:	0,1 - 0,4 MPa
(1 MPa = 10 bar = 147 PSI)	
Temperatura vruće vode:	maks. 60°C

Opis simbola



Nemojte koristiti silikon koji sadrži sirćetnu kiselinu!



Pomoću ekscentara mogu se podesiti tolerancije povrta. (vidi stranu 35 + 37)



Mere (vidi stranu 31 - 33)



Dijagram protoka
(vidi stranu 32)



Rukovanje (vidi stranu 39 - 40)



Čišćenje (vidi stranu 41) i priložena brošura



Rezervni delovi (vidi stranu 42)

Poseban pribor

garnitura za ugaonu montažu (28694000)
Nije sadržano u isporuci



Ispitni znak (vidi stranu 43)

Montaža

27636XXX/27893000/27658000









Montaža

27637000/27638000



Sikkerhetshenvisninger

-  Bruk hansker under montasjen for å unngå klem- og kuttskader.
-  Barn og voksne med fysiske og psykiske og/eller sensoriske handicap skal ikke bruke dusjsystemet uten oppsyn. Personer som er påvirket av alkohol eller narkotika skal ikke bruke dusjsystemet.
-  Dusjstrålen skal ikke komme i kontakt med ømfintlige kroppsdeler (f.eks. øynene). Overhold en tilstrekkelig avstand mellom dusjen og kroppen.
-  Produktet skal ikke brukes som holdegrep. Det skal monteres en separat holdegrep.
-  Dusjsystemet skal kun brukes for bade-, hygiene- og kropprensingsformål.
-  Dusj slanger er kun egnet for tilkobling av dusj til armaturer. Det er ikke tillatt med en avsperring etter slangen i gjennomstrømningsretning!

Montagehenvisninger

- Armaturen skal monteres, spyles og sjekkes iht. gyldige standarder.
- Når kvalifisert fagfolk monterer produktet, skal man påse at hele området der produktet monteres er plant (ingen fremstående fuger eller flisekanter), at oppbygging av veggen er egnet for montasje av produktet og at veggen ikke viser noen svakheter. Medleverte skruer og plugg er egnet seg kun for betong. Ved en annen veggoppbygging skal man ta hensyn til pluggproduzentens henvisninger.
- Det medleverte filter-elementet skal bygges inn, for å garantere hånddusjens standard-gjennomstrømning og for å forhindre at smuss spyles inn fra ledningsnettet. Ønsker man en større vanngjennomstrømning skal det monteres en silpakning (94246000) isteden for filterelementet (97708000). Innspyling av smuss kan påvirke funksjonen negativt og/eller medføre skader på hånddusjens funksjonsdeler. Hansgrohe påtar seg inget ansvar for skader som resulteres av dette.
- Dusjstangen skal monteres spenningsfritt!
- Optimal funksjon garanteres kun i forbindelse med Hansgrohe hånddusj og Hansgrohe dusjslanger.

Tekniske data

Driftstrykk	maks. 0,6 MPa
Anbefalt driftstrykk: (1 MPa = 10 bar = 147 PSI)	0,1 - 0,4 MPa
Varmtvannstemperatur	maks. 60°C

Symbolbeskrivelse



Ikke bruk silikon som inneholder eddiksyre!



Boretoleranser kan utlignes ved hjelp av eksenterbøssing. (se side 35 + 37)



Mål (se side 31 - 33)



Gjennomstrømningsdiagram
(se side 32)



Betjening (se side 39 - 40)



Rengjøring (se side 41) og vedlagt brosjyre



Service-deler (se side 42)

Ekstratilbehør

Sett for hjørnemontasje (28694000) ikke med i leveransen



Prøvemerket (se side 43)







Montasje
27636XXX/27893000/27658000
se side 34



Montasje
27637000/27638000
se side 36



Указания за безопасност

-  При монтажа трябва да се носят ръкавици, за да се избегнат наранявания поради притискане или порязване.
-  Не е позволено деца, както и възрастни с физически, умствени и / или сензорни ограничения да използват системата на душа без надзор. Не е позволено използването на системата на душа от лица, употребили алкохол или дрога.
-  Трябва да се избягва контакта на струите на разпръсквателя с чувствителни части на тялото (напр. очите). Между разпръсквателя и тялото трябва да се спазва достатъчно разстояние.
-  Продуктът не бива да се използва като дръжка. Трябва да се монтира отделна дръжка.
-  Позволено е използването на системата на душа само за къпане, хигиена и цели на почистване на тялото.
-  Маркучите на разпръсквателите са подходящи само за свързване на разпръскватели към арматури. Не се допуска блокиране след маркуца по посоката на протичане!

Указания за монтаж

- Арматурата трябва да се монтира, промие и провери в съответствие с валидните норми.
- При монтаж на продукта от квалифицирани специалисти да се внимава за това, закрепващата повърхност в целия диапазон на закрепването да бъде равна (без изпъкнали fugи или изместване на плочки), конструкцията на стената да е подходяща за монтаж на продукта и особено за това, да няма слаби места. Приложените винтове и дюбели са подходящи само за бетон. При други стени конструкции да се спазват данните на производителя на дюбели.
- Опакованата към него филтърна вложка (97708000) трябва да се монтира, за да се осигури нормалния поток към ръчния разпръсквател и да се избегне натрупване на замърсявания от водопроводната мрежа. Ако желаете по-силно протичане на вода, вместо филтърната вложка (97708000) поставете уплътнението с седка (94246000). Натрупването на замърсявания може да наруши функцията и/или

- да доведе до увреждания на функционалните части на ръчния разпръсквател, Hansgrohe не носи отговорност за получените се по този начин щети.
- Постът на разпръсквателя трябва да се монтира без напрежение!
 - Оптималното функциониране се гарантира само във връзка с ръчните разпръскватели и маркучите на разпръскватели на Hansgrohe.

Технически данни

Работно налягане:	макс. 0,6 МПа
Препоръчително работно налягане:	0,1 - 0,4 МПа (1 МПа = 10 bar = 147 PSI)
Температура на горещата вода:	макс. 60 °C

Описание на символите



Не използвайте силикон, съдържащ оцетна киселина!



Допуските при пробиване могат да се изравнят с ексцентричната втулка. (вижте стр. 35 + 37)



Размери (вижте стр. 31 - 33)



Диаграма на потока
(вижте стр. 32)



Обслужване (вижте стр. 39 - 40)



Почистване (вижте стр. 41) и приложена брошура



Сервизни части (вижте стр. 42)



Контролен знак (вижте стр. 43)

Монтаж

27636XXX/27893000/27658000

28

вижте стр. 34









Монтаж

27637000/27638000

вижте стр. 36



Udhëzime sigurie

-  Për të evituar lëndimet e pickimeve ose të prerjeve gjatë procesit të montimit duhet që të vishni doreza.
-  Fëmijët dhe të rriturit me aftësi të kufizuara fizike, mendore dhe/ose ndijuese nuk duhet ta përdorin sistemin e dushit pa qenë nën mbikëqyrje. Personat që janë nën ndikimin e drogave ose të alkoolit nuk duhet ta përdorin sistemin e dushit.
-  Kontakti i valëve të dushit me pjesët e ndjeshme të trupit (p.sh. me sytë) duhet që të shmanget. Midis dushit dhe trupit duhet që të mbahet një distancë e mjaftueshme.
-  Produkti nuk duhet të përdoret si dorëze mbajtëse. Duhet të montohet një dorëzë mbajtëse e veçantë.
-  Sistemi i dushit duhet të përdoret vetëm qëllimet e banjave, të higjienës dhe të larjes së trupit.
-  Zorra e dushit mund të përdoren vetëm për lidhjen e spërkatëseve me armaturën. Ndalohet bllokimi pas zorrës në drejtim të rrjedhjes!

Udhëzime për montimin

- Armatura duhet montuar, shpërlarë dhe kontrolluar në bazë të normave të vlefshme.
- Gjatë montimit të produktit nga ana e personit të kualifikuar duhet pasur parasysh që e gjithë sipërfaqja mbërthyesë të jetë e drejtë (nuk duhet të ketë hapësira mes pllakave). Mbi të gjitha muri duhet të jetë i përshtatshëm për montim dhe nuk duhet të ketë pika të dobëta. Vidhat dhe kunjat e bashkangjitura janë të përshtatshme vetëm për beton. Te përbërja tjetër murore të merren parasysh të dhënat e prodhuesit të kunjave.
- Filtri i bashkëngjitur (97708000) duhet montuar për të garantuar rrjedhjen sipas normave të ujit nga spërkatësja si dhe për të evituar thithjen e ndotjeve nga tubacionet e ujësjellësit. Nëse dëshironi më shumë vëllim uji, atëherë në vend të filtrit (97708000) duhet të përdorni sitën (94246000). Ndotjet mund të dëmtojnë pjesë funksionale të spërkatësës. Hansgrohe nuk merr përgjegjësinë për dëmet e shkaktuara në këtë mënyrë.
- Shtanga e spërkatësës duhet montuar pa tension!
- Garantohet funksioni optimal vetëm në kombinim me spërkatëset Hansgrohe si dhe zorrat e dushit Hansgrohe.

Montimi

27636XXX/27893000/27658000

shih faqen 34



Të dhëna teknike

Presioni gjatë punës	maks. 0,6 MPa
Presioni i rekomanduar:	0,1 - 0,4 MPa
(1 MPa = 10 bar = 147 PSI)	
Temperatura e ujit të ngrohtë	maks. 60°C

Përshkrimi i simbolit



Mos përdorni silikon që në përbërje ka acid acetik.



Përmes kutisë ekscentrike mund të ekuilibrohen tolerancat gjatë shpimit. (shih faqen 35 + 37)



Përmasat (shih faqen 31 - 33)



Diagrami i qarkullimit
(shih faqen 32)



Përdorimi (shih faqen 39 - 40)



Pastrimi (shih faqen 41) dhe broshura bashkëngjitur



Pjesë ndërrimi (shih faqen 42)

Pajisje të posaçme

Seti i montimit këndor (28694000) nuk përfshihet në vëllimin e furnizimit



Shenja e kontrollit
(shih faqen 43)

Montimi

27637000/27638000

shih faqen 36



المواصفات الفنية

الحد الأقصى 0,6 ميجاباسكال
الحد الأدنى 0,1 - 0,4 ميجاباسكال
ضبط التشغيل:
ضغط التشغيل الموصى به:
(1 ميجاباسكال = 10 بار = PSI 147)
درجة حرارة الماء الساخن:
الحد الأقصى 60°C

وصف الرمز

هام! لا تستخدم السليكون الذي يحتوي على أمضاض!



باستخدام الحلقة اللامركزية يمكن معادلة خلوص
الثقب. (راجع صفحة 35 + 37)



أبعاد (راجع صفحة 31 - 33)



رسم للصراف
(راجع صفحة 32)



التشغيل (راجع صفحة 39 - 40)



التنظيف (راجع صفحة 41) والكتيب المرفق



قطع الغيار (راجع صفحة 42)



ملحقات خاصة

جموعة تركيب بزواوية (28694000) غير مدرج مع
المحتويات المسلمة

شهادة اختبار (راجع صفحة 43)



تنبيهات الأمان



يجب ارتداء قفازات لليد أثناء التركيب لتجنب حدوث
أخطار الإنحشار أو الجروح.



ممنوع إستخدام نظام الدش بدون ملاحظة من بالغين سواء
في حالة إستخدامه من طرف أطفال أو بالغين يعانون من
قصور جسدي أو عقلي أو عصبي يمنعمهم من الإحساس
بدرجات حرارة المياه. لا يسمح لأي شخص تحت تأثير
تناول الكحول أو المخدرات من إستخدام نظام الدش.



يجب تجنب حدوث إتصال مباشر بين الماء الخارج من
رأس الدش وبين أجزاء الجسم الحساسة (مثل العينين).
يجب وجود مسافة كافية بين رأس الدش والجسم.



ممنوع إستخدام المنتج كمقبض. يجب تركيب مقبض
منفصل.



يجب إستخدام نظام الدش فقط لأغراض الإستحمام
والأغراض الصحية وأغراض تنظيف الجسم.



لا تصلح خراطيم الدش إلا للتوصيل من الدش إلى
الوصلة. حذار من تركيب جهاز إغلاق بين الوصلة
والخرطوم.



تعليمات التركيب

- يجب تركيب الوصلة واستخدامها واختبارها وفقاً للمعايير المعمول بها.
- يجب الانتباه عند تركيب المنتج بواسطة فريق العمل المتخصص إلى أن جميع مواضع التثبيت جاهزة للتثبيت دون عوائق (خالية من المفصلات أو المصقات)، وأن الحائط جاهز لتركيب المنتج مع عدم احتوائه على أية أماكن ضعيفة. مبيئات المسامير (الفيشر) والمسامير نفسها مناسبة للحوائط الخرسانية فقط، ويجب الالتزام بتعليمات الجهة المصنعة لمبيئات المسامير عند التثبيت في أنواع أخرى من الحوائط.
- يجب استخدام وليجة المرشح (97708000) لضمان الحصول على معدل التدفق القياسي وحماية الدش اليدوي من الأوساخ التي تحملها شبكة المواسير. هل تريد الحصول على معدل تدفق أعلى؟ إذن يجب أن تستخدم حشية المرشح (94246000) بدلاً من وليجة المرشح (97708000). حيث تؤدي الأوساخ الواردة إلى حدوث أعطال أو / و قد تتسبب في تلف أجزاء من من الدش اليدوي، ومثل هذه الأعطال تلغي كافة المطالبات الخاصة بالمسؤولية أو الضمان.
- يجب تركيب قضيب الحائط بحيث لا يكون واقعاً تحت ضغط!
- لا يمكن ضمان الحصول على الأداء الأمثل إلا من خلال الجمع بين الدش اليدوي إنتاج هانز جروهه وخرطوم الدش إنتاج هانز جروهه.

الترتيب

27636XXX/27893000/27658000

راجع صفحة 34

الترتيب

27637000/27638000

راجع صفحة 36



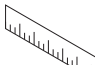

Raindance Unica'S 27636000

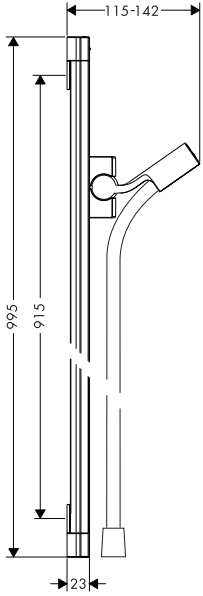

Raindance Unica'S Set EcoSmart 27658000
Raindance Unica'S Set 27893000

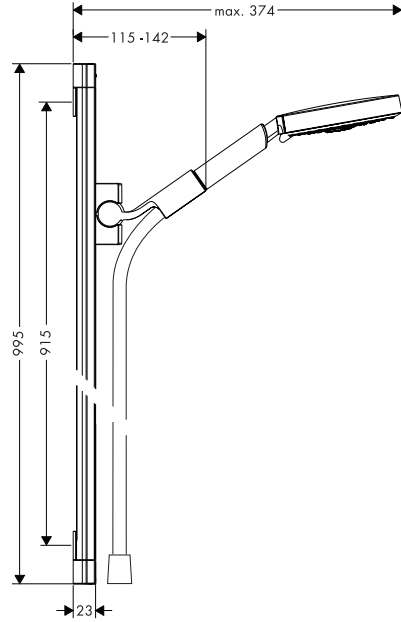

Raindance Unica'S 27637000

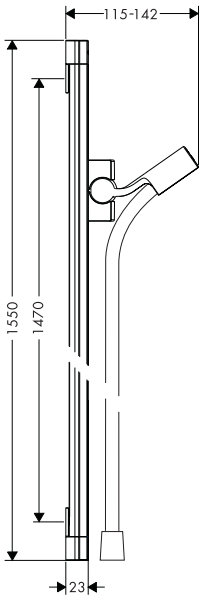

Raindance Unica'S Set 27638000

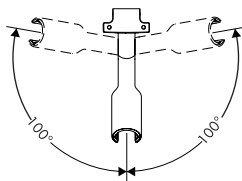
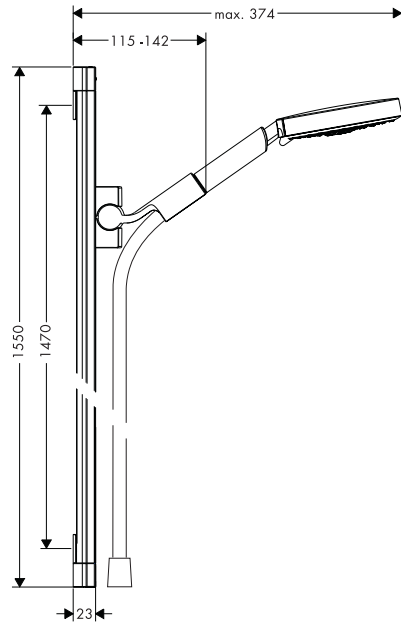



Raindance S 150 3jet 28519000
Raindance S 150 3jet EcoSmart 28550000

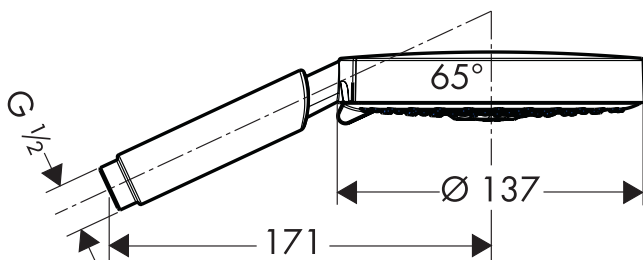
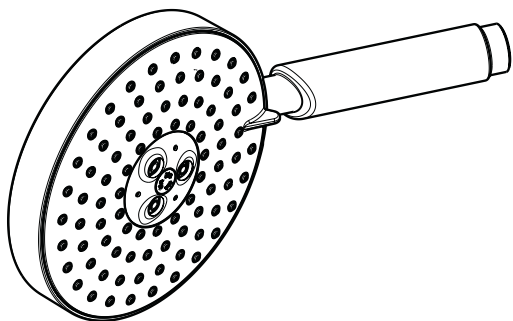

Raindance S 150 AIR 3jet 28519000
Raindance S 150 3jet EcoSmart 28550000



Raindance S 150 5jet
 28519000

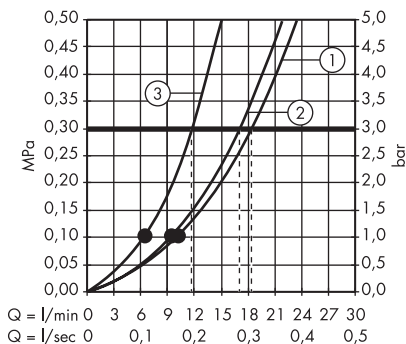

Raindance S 150 3jet EcoSmart
 28550000

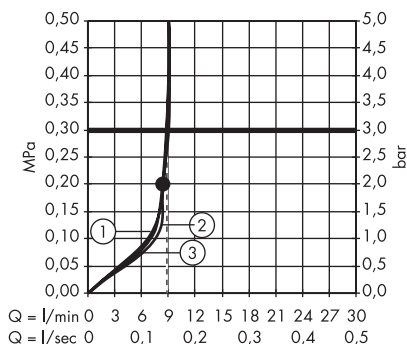

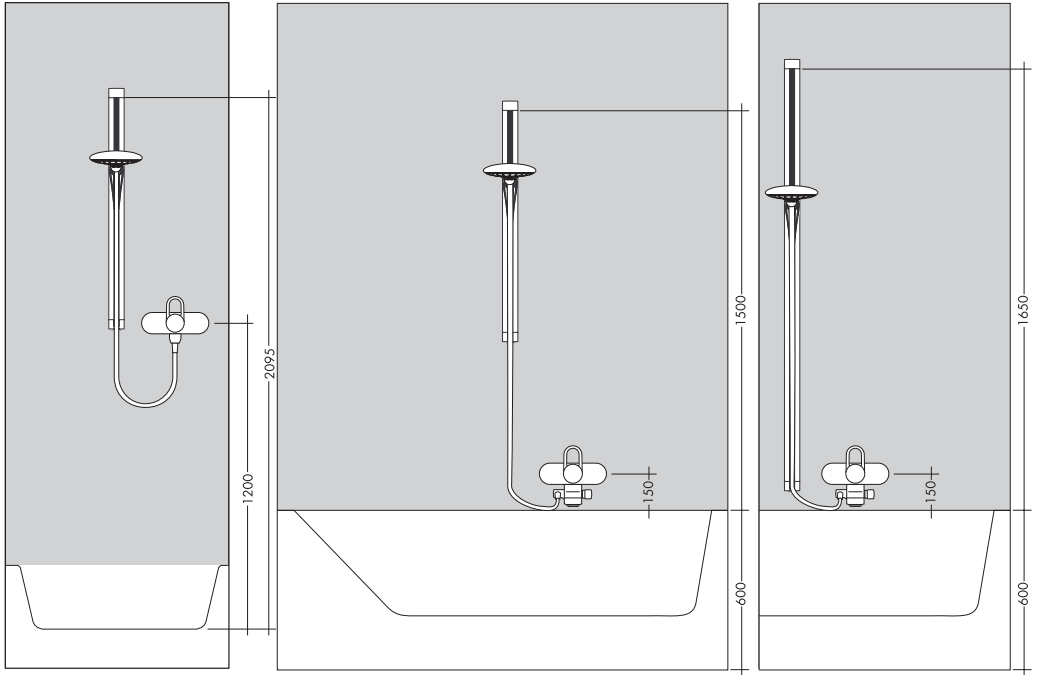
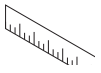



Raindance Unica'S

27636XXX

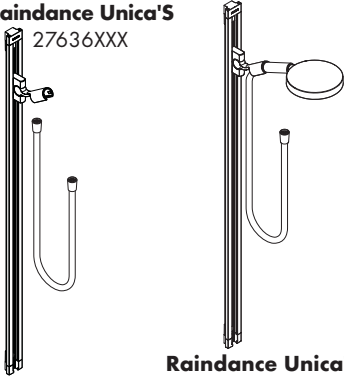

Raindance Unica'S Set
27893000 / 276580000

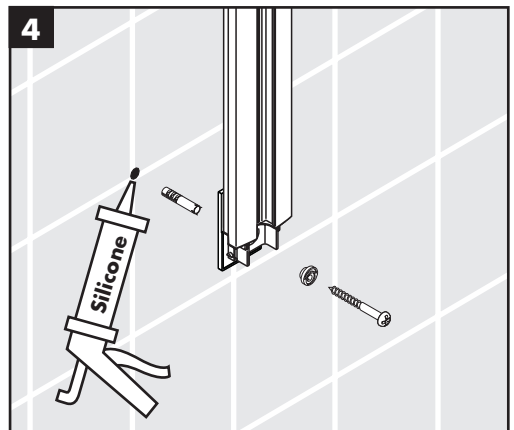
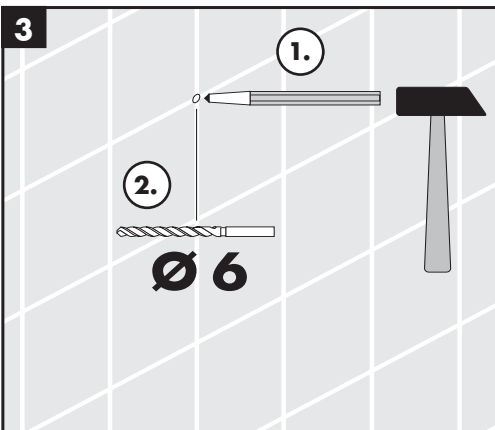
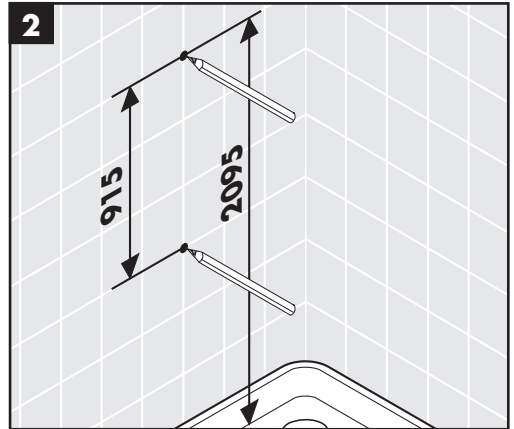
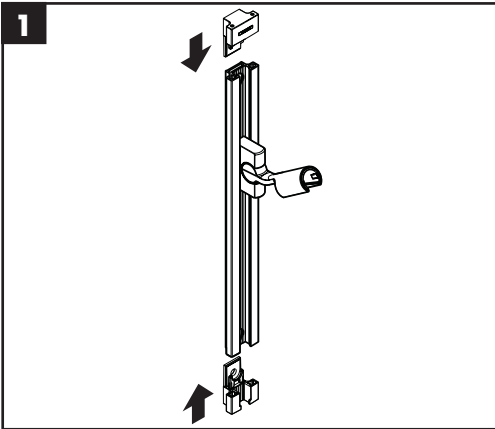
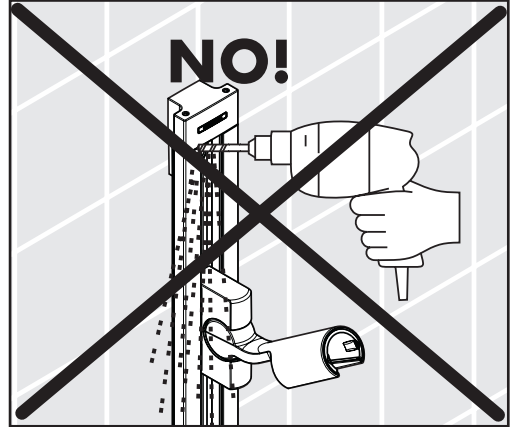

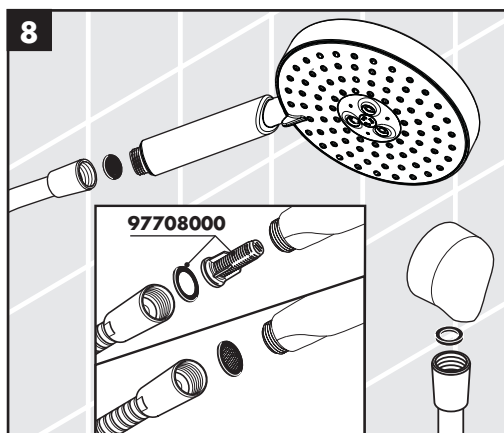
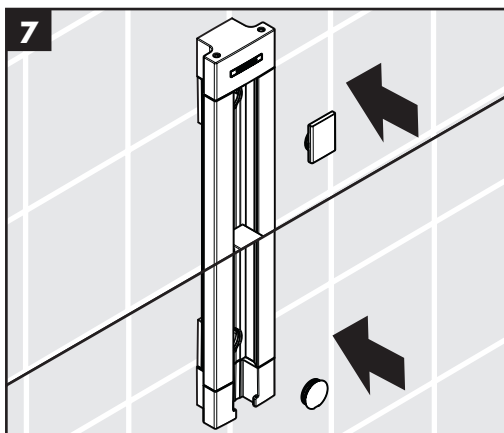
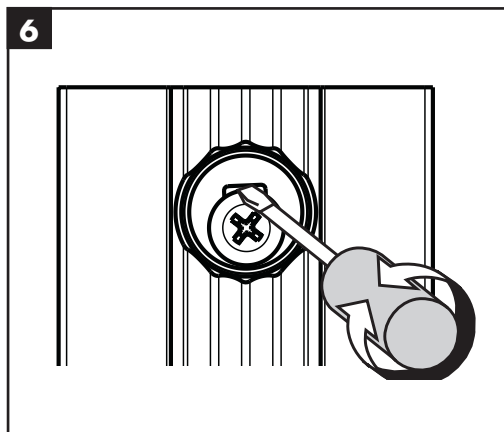
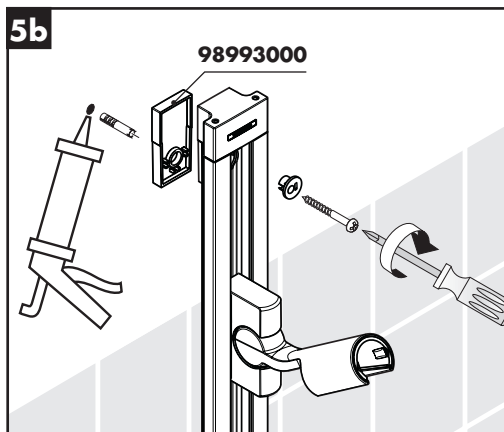
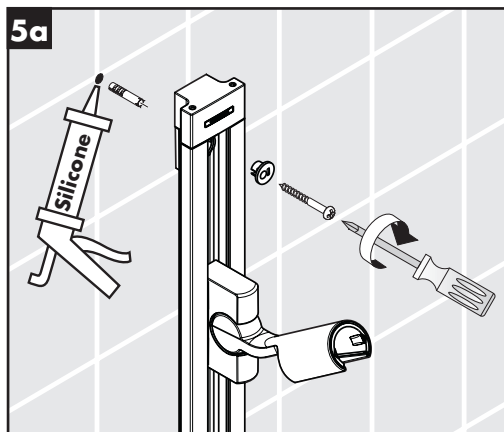
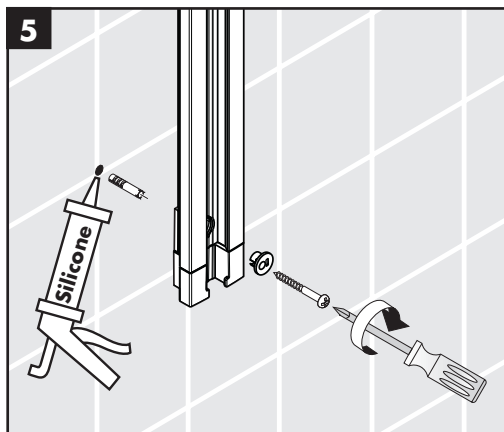



Raindance Unica'S

27637XXX

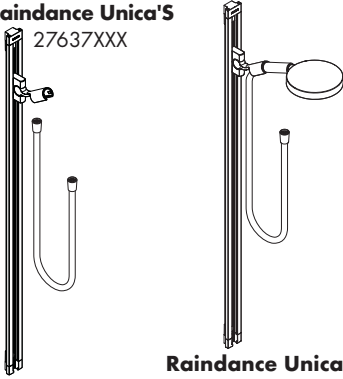

Raindance Unica'S Set
27638000

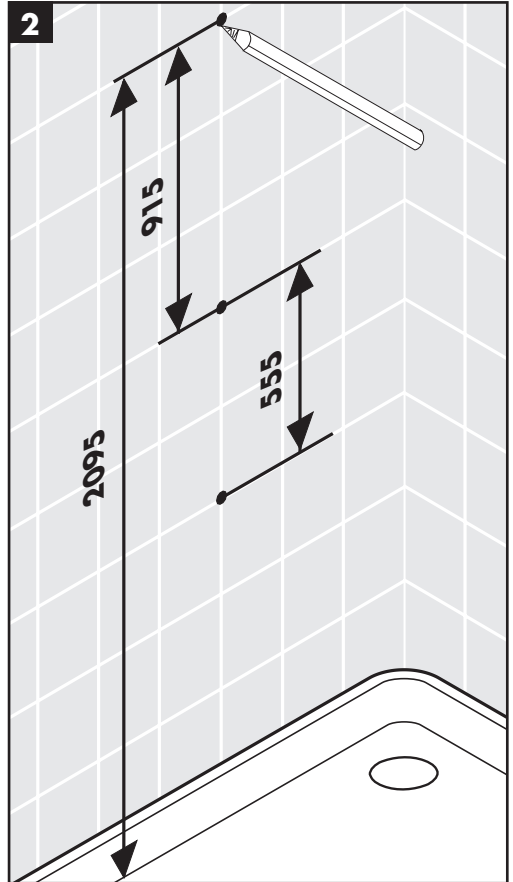
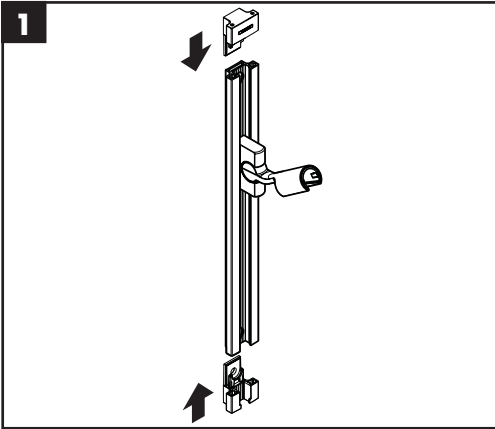
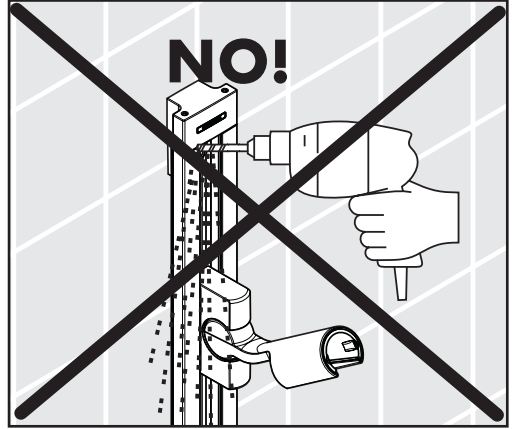

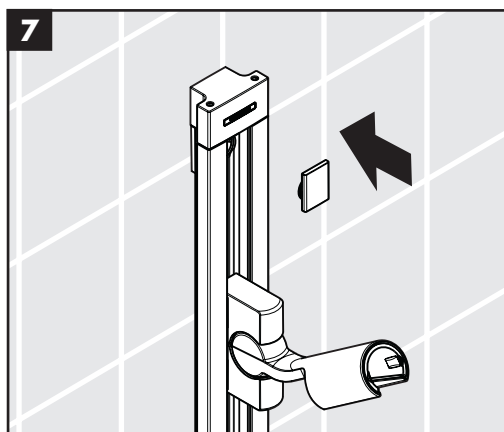
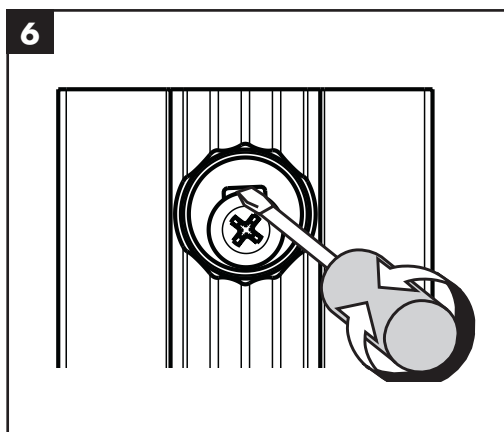
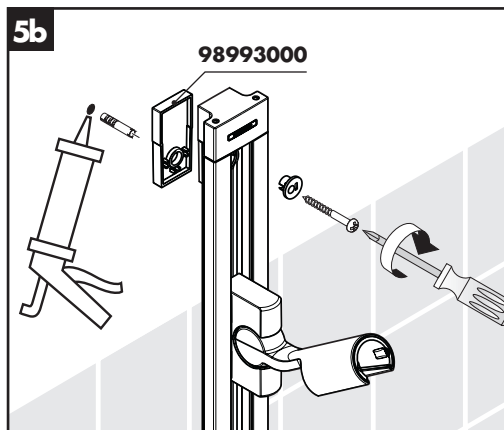
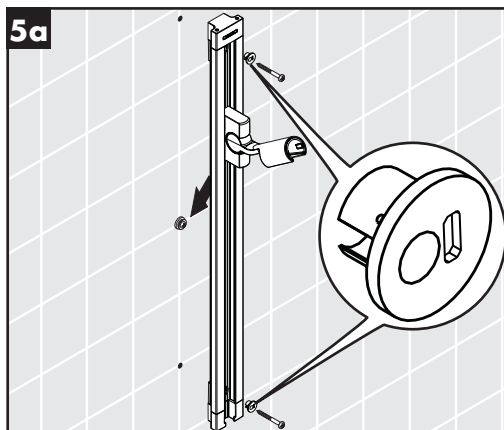
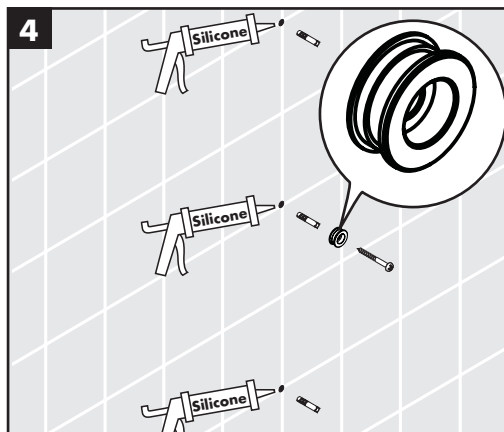
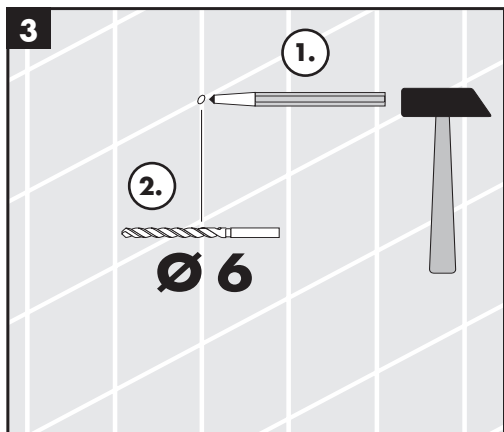

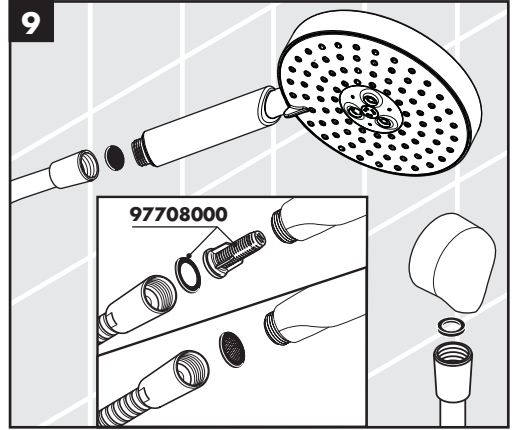
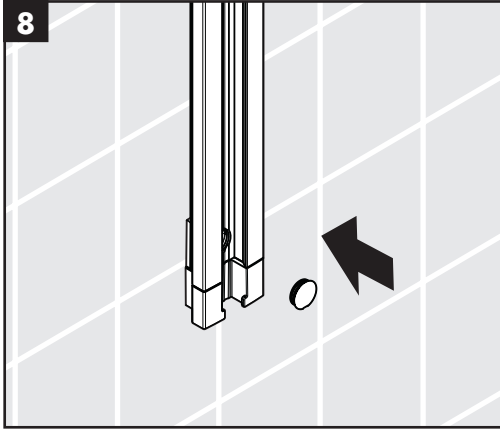

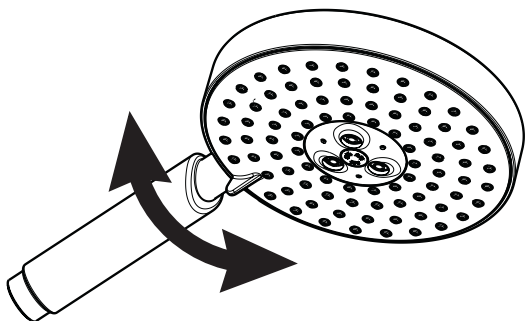

Raindance S 150 AIR 3jet 28519000

Raindance S 150 3jet EcoSmart 28550000

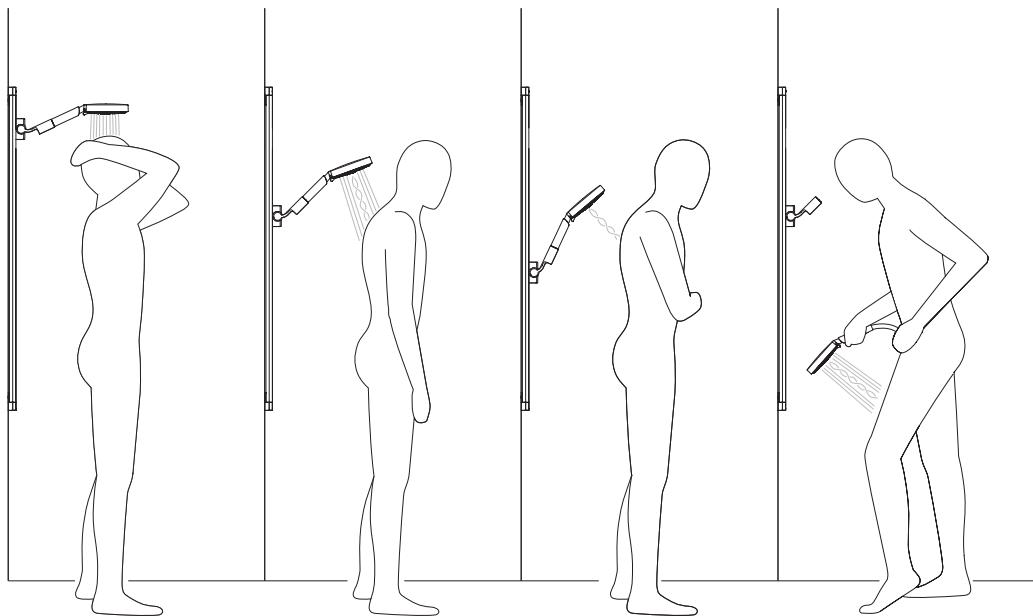

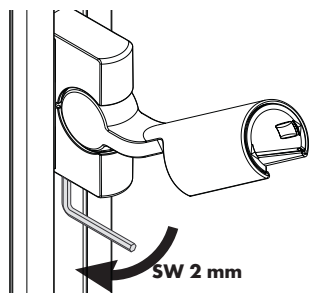
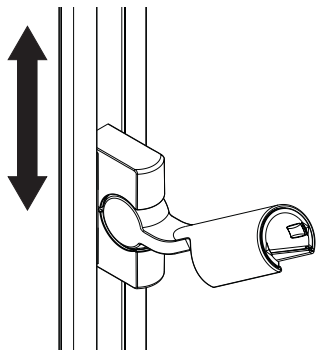

leichter / plus facile / easier / plus facile /
 más ligero / lichter / lettere / piú allentato / stabiej
 / snazši / l'ahšie / 更加简单 / легче / kónnyebb
 / helpommin / lättare / lengviau / lakše / daha
 hafif / mai ușor / ευκολότερα / lažje / kergem /
 vieglāks / lakši / lettere / нек / më i lehtë / أسهل

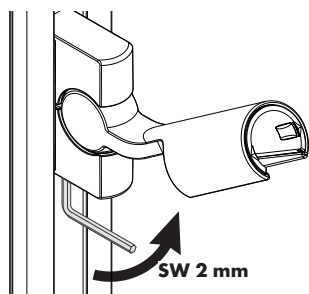

schwerer / mais difcil / harder / plus difficile /
 más pasado / zwaarder / zwaarder / piú serrat /
 mocniej / obťažnějši / t' ažšie / 更坚固 / стабільнее /
 nehezebb / vaikeampi / tyngre / sunkiau / teže / ađır
 / mai greu / βαρύτερα / težje / raskem / smagāks /
 teže / tyngre / по-трудно / më e rëndë / أصعب

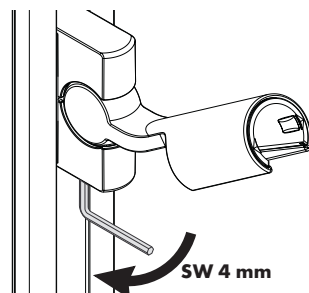
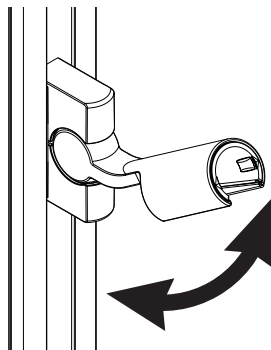

leichter / plus facile / easier / plus facile /
 más ligero / lichter / lettere / piú allentato / stabiej
 / snazši / l'ahšie / 更加简单 / легче / kónnyebb
 / helpommin / lättare / lengviau / lakše / daha
 hafif / mai ușor / ευκολότερα / lažje / kergem /
 vieglāks / lakši / lettere / нек / më i lehtë / أسهل

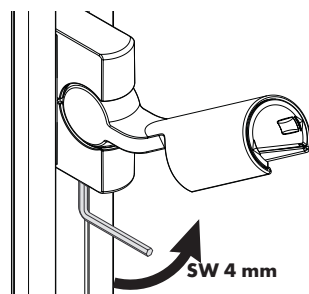

schwerer / mais difcil / harder / plus difficile /
 más pasado / zwaarder / zwaarder / piú serrat /
 mocniej / obťažnějši / t' ažšie / 更坚固 / стабільнее /
 nehezebb / vaikeampi / tyngre / sunkiau / teže / ađır
 / mai greu / βαρύτερα / težje / raskem / smagāks /
 teže / tyngre / по-трудно / më e rëndë / أصعب

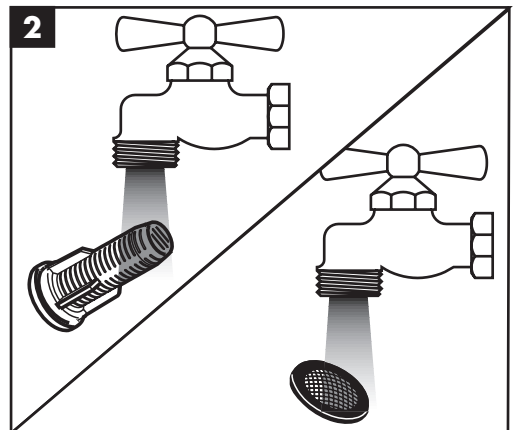
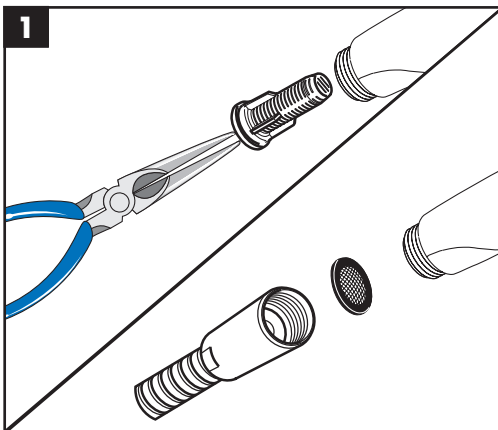
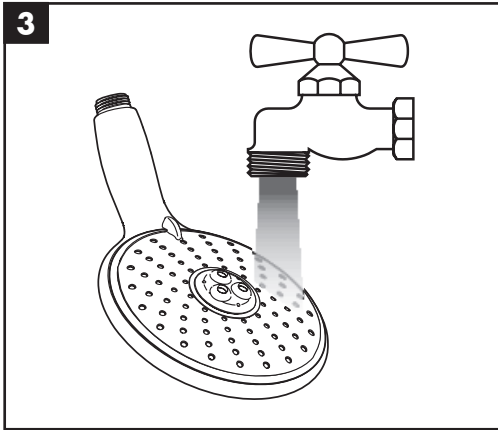
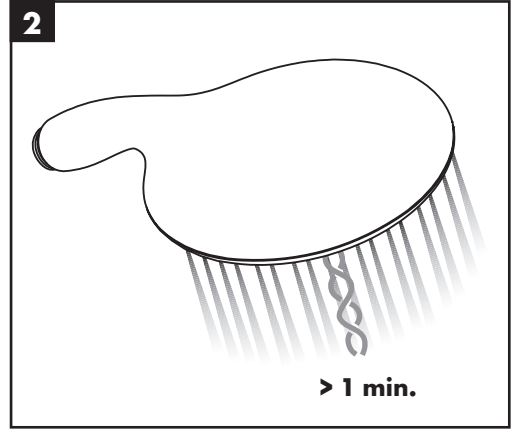
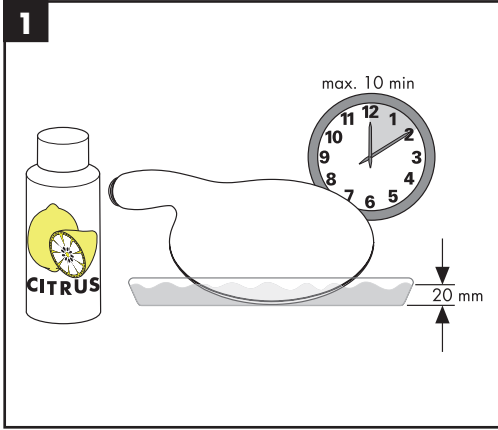

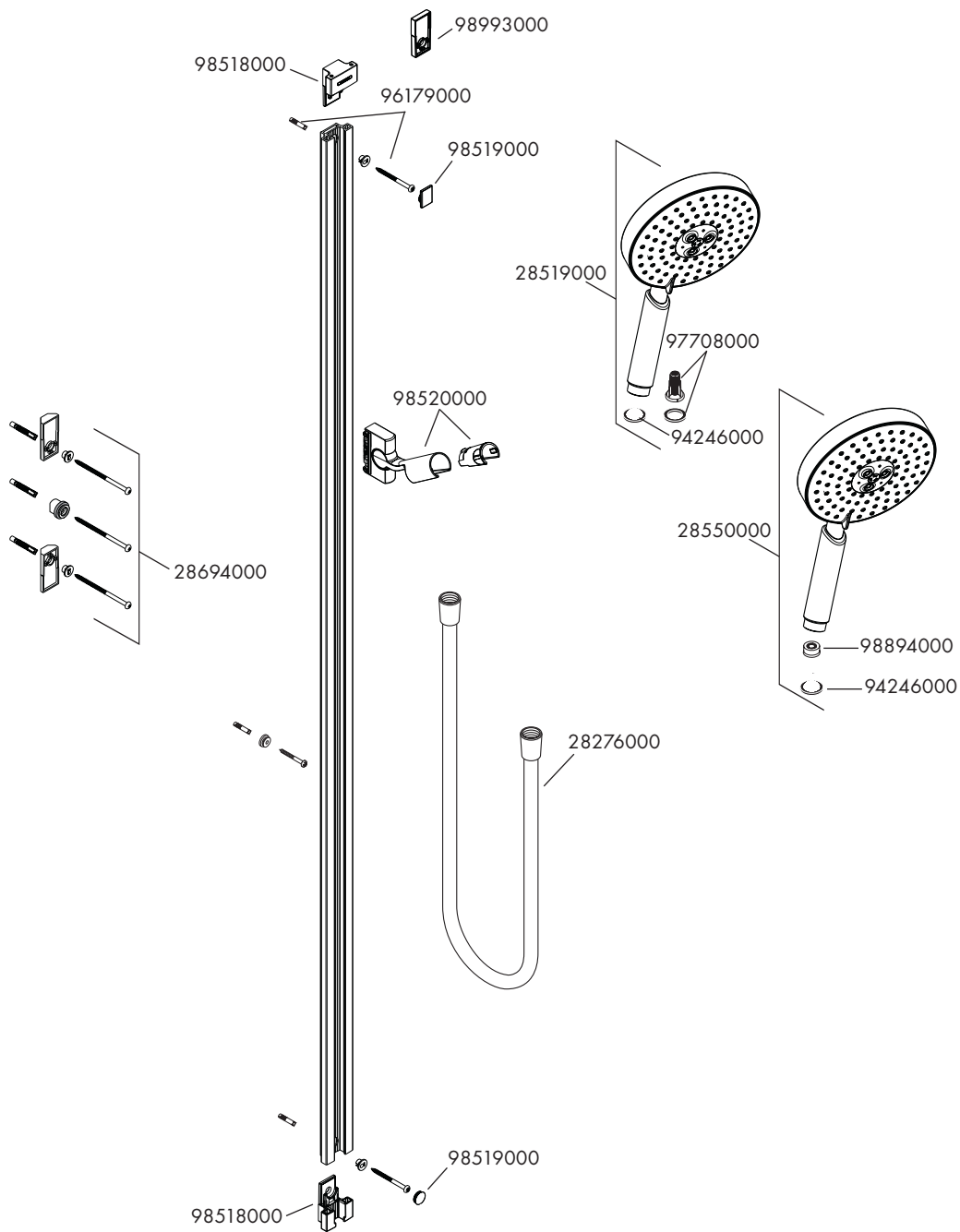



	P-IX	DVGW	SVGW	WRAS	KIWA	NF	ACS	ETA
27636000							X	
27637000							X	
27638000							X	
27658000							X	
27893000							X	

hansgrohe

Hansgrohe - Postfach 1145 · D-77761 Schiltach · Telefon +49 (0) 78 36/51-1282 · Telefax +49 (0) 7836/511440
E-Mail: info@hansgrohe.com · Internet: www.hansgrohe.com

10/2010
9.04500.04