

Installation Instructions / Cleaning

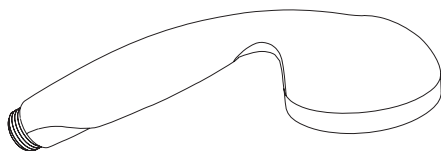

Croma 1jet
28574000

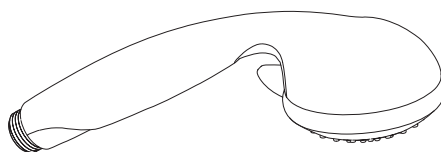

Croma 2jet / Croma 3jet
28575000 / 28576000

hansgrohe



Ihr Online-Fachhändler für:

hansgrohe

- Kostenlose und individuelle Beratung
- Hochwertige Produkte
- Kostenloser und schneller Versand

- TOP Bewertungen
- Exzelerter Kundenservice
- Über 20 Jahre Erfahrung



E-Mail: info@unidomo.de | Tel.: 04621 - 30 60 89 0 | www.unidomo.de

Croma 1jet
28574000

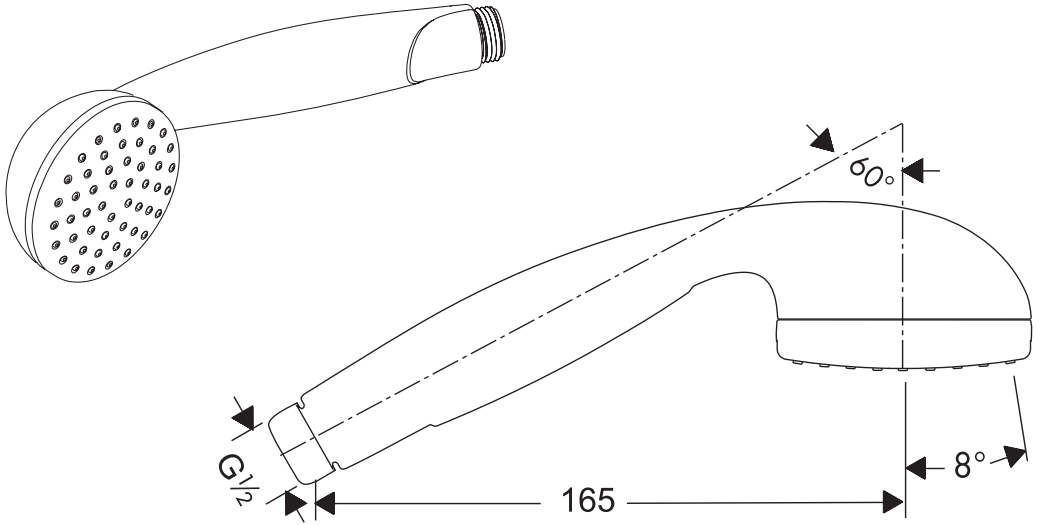
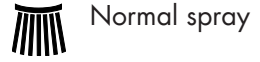

Croma 2jet
28575000

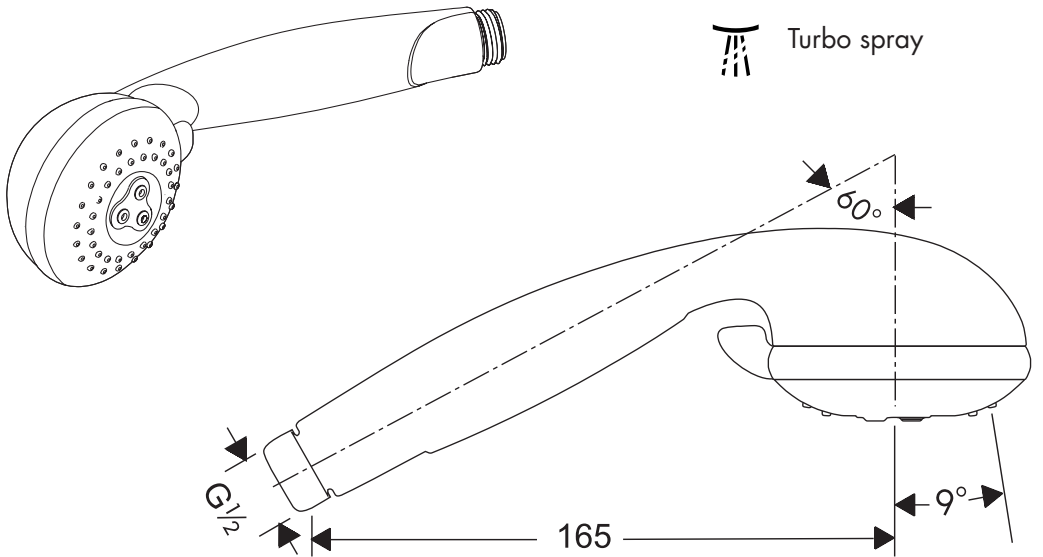
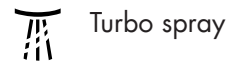
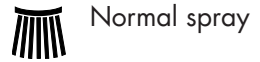

Croma 3jet
28576000

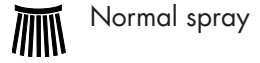
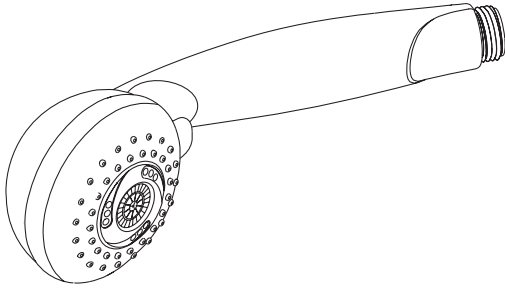

Normal spray



Soft spray



Massage jet

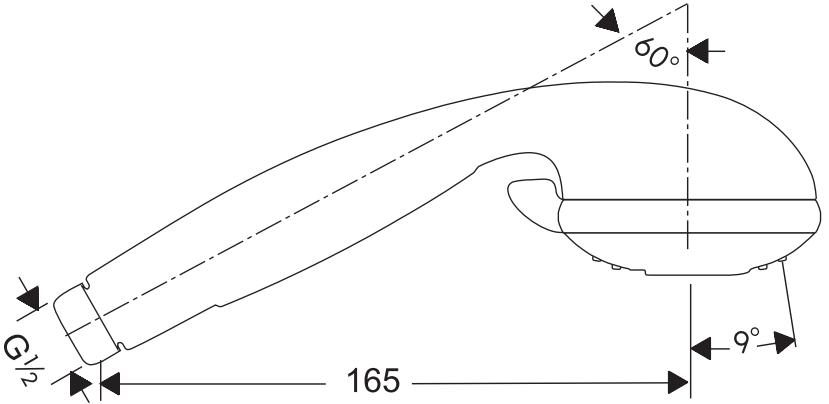

Technical Data

Operating pressure:

max. 6 bar

Hot water temperature:

max. 60 °C

Croma 1jet

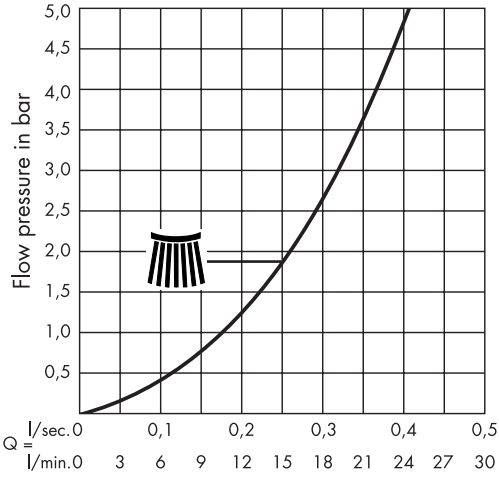

Croma 2jet

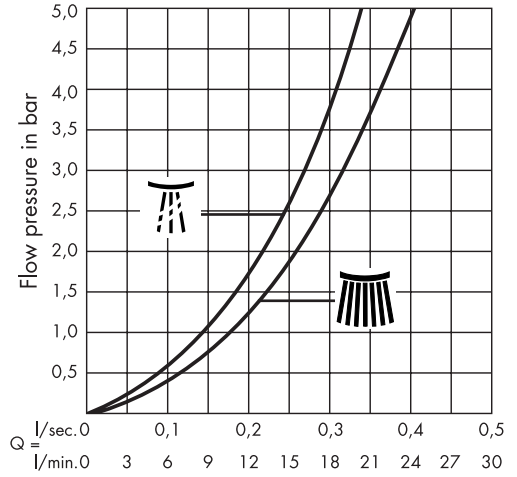

Croma 3jet

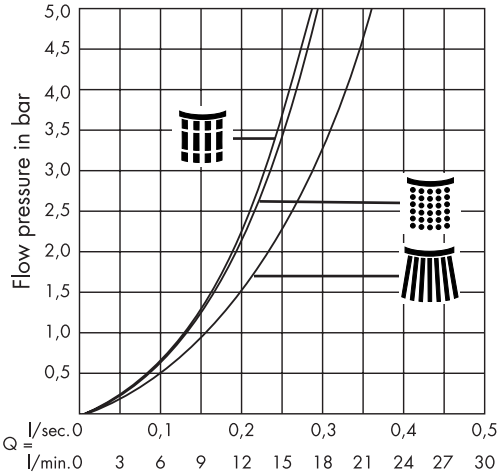

Normal spray



Soft spray



Massage jet



Turbo spray

Assembly

The mesh washer must be inserted to protect the hand shower against incoming dirt by pipework. Incoming dirt leads to defects or/and can damage parts of the hand shower; such caused faults voids all liability and guarantee claims.

Hansgrohe hand showers can be used together with hydraulically and thermally controlled continuous flow heaters if the flow pressure is at least 1,5 bar in front of the shower fitting.

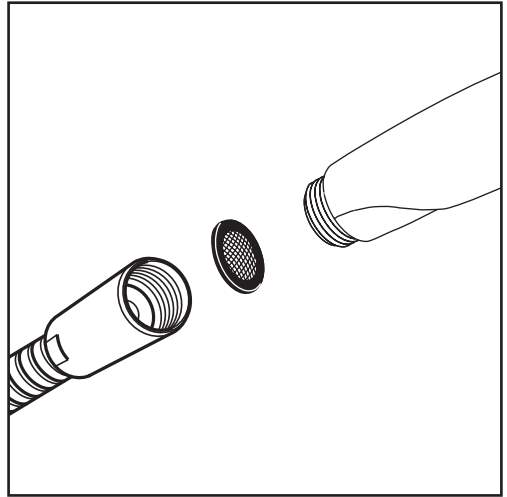

The Rubit cleaning function only needs a small manual rubover to remove the lime scale from the spray channels.

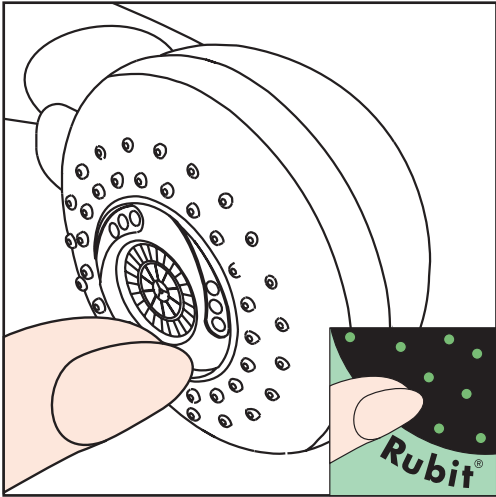

Cleaning Recommendation for Hansgrohe Products

Modern sanitary tapware, kitchen mixers and showers consist of very different materials to comply with the needs of the market with regard to design and functionality.

To avoid damage and reclamations, it is necessary to consider certain criteria when cleaning.

Cleaning Materials for Mixers and Showers

Acids are necessary ingredients of cleaning materials for removing lime, however please pay attention to the following points when cleaning mixers and showers:

- Only use cleaning material which is explicitly provided for this type of application, such as Hansgrohe's Decalcifying Agent, which is available through the specialist sanitary trade.
- Never use cleaning materials, which contain hydrochloric, formic or acetic acid, as they cause considerable damage.
- Phosphoric acid is also restricted as it can cause damage.
- Never mix any cleaning material with another.
- Never use cleaning materials or appliances with an abrasive effect, such as unsuitable cleaning powders, sponge pads or micro fibre cloths.

Cleaning Instructions for Mixers and Showers

Please follow the cleaning material manufacturer's instructions. In addition pay attention to the following points:

- Clean the mixers and showers as and when required
- The cleaning dosage and time the cleaner needs to take effect should be adjusted according to the product and the cleaner should not be left longer than necessary.
- When using spray cleaner, spray first into a cloth or sponge never directly onto the sanitary tapware, as drops could enter openings and gaps and cause damage.
- After cleaning rinse thoroughly with clean water to remove any cleaner residue.

Important

Residues of liquid soaps, shampoos and shower foams can also cause damage, so rinse with clean water after using.

If the surface is already damaged, the effect of cleaning materials will cause further damage.

Damage caused by improper treatment will not be covered by our guarantee.

A

Hansgrohe
Postfach 85
2355 Wr. Neudorf
Telefon: 0 22 36 / 6 28 30
Telefax: 0 22 36 / 62 83 019

D

Hansgrohe
D-77757
Schiltach / Schwarzwald
Telefon: 0 78 36 / 51-0
Telefax: 0 78 36 / 51 13 00

F

Hansgrohe
6/8 rue Henri-Poincaré Z. A.
92167 Antony Cedex
Téléphone: 01 40 96 40 00
Télécopie: 01 46 66 49 89

HR

Hansgrohe
Omega Nova-Sibenik D.O.O.
K.Zvonimira BB
22000 Sibenik
Telefon: 00 385/(0)22/310 450
Telefax: 00 385/(0)22/330 221

NL

Hansgrohe B.V.
Handelsweg 45
NL - 1525 RG Westknollendam
Telefoon: 075 6461400
Telefax: 075 6461700

RO

Representative Office
Apsa Sasori
Bd.O.Goga nr.4(106),bl M26,sc.3,ap.68
7000 Bucuresti
Romania
Tel./Fax: (0040) 0 21 326 10 01

SLO

Representative Office Hansgrohe
Riharjeva 2
1000 Ljubljana
Slovenia
Tel.:00386 1 429 23 32
Fax:00386 1 429 23 33

USA

Hansgrohe
1490 Bluegrass Lakes Parkway
Alpharetta, GA 30004/USA
Tel.: 770-360-9880
Fax: 770-360-9887

B

Hansgrohe
Rue Vanderschrick Straat 91
1060 Bruxelles/Brussel
Téléphone: 02 / 5 43 01 40
Telefax: 02 / 5 37 94 86

DK

Hansgrohe
Jegstrupvej 6
8361 Hasselager
Telefon: 86 28 74 00
Telefax: 86 28 74 01

FIN

Hansgrohe
Juhani Niemi Oy
Mänytie 11
00270 Helsinki
Puh: (09) 47 77 030
Telefax: (09) 24 17 554

I

Hansgrohe
S.S. 10 KM 24,4
14019 Villanova d'Asti
Telefono: 0 141 / 93 11 11
Telefax: 0 141 / 94 65 94

P

HGAXorPharo SA
R. Antoine de Saint-Exupéry
Alapraia
2765-043 Estoril
Telefona: 21 466 71 10
Fax: 21 466 71 19

RUS

Hansgrohe
Усаева 33/1
1190408 Россия Москва
Tel.: 095 / 9333170
Fax: 095 / 9333171

TR

Dizayn Ev Gerecleri
San. ve Tic. Ltd. Sti.
Ortaokul Cad. No. 1
Mecidiyekoye-Istanbul 80290
Tel.: 0090-212-266 50 80
Fax: 0090-212-275 75 12

CH

Hansgrohe
Industriest. 9
5432 Neuenhof
Telefon: 056/416 26 26
Telefax: 056/416 26 27

E

Hansgrohe
Riera Can Pahissa 26 B
08750 Molins de Rei
Telefon: 93 680 39 00
Telefax: 93 680 39 09

GR

Nikitas Vlachos
Niveco SA
Posidonas Ave 46
17561 P. Faliró
Telefon: (01) 9880180
Telefax: (01) 9883847

IND

Jaquar Mercantile
D-26, SMA Co-operative Industrial Estate
G.T. Karnal Road
Delhi-110033
Tel : +91-11-27240388, 27466808
Fax:+91-11-27240388, 27466808

PL

Hansgrohe
Ul. Sowia 12
PL-62-080 Tarnowo Podgórze
Telefon: (061) 8168600
Telefax: (061) 8168609

S

Hansgrohe AB
Ridsögatan 10
S-21377 Malmö
Telefon: +46/(0)40/51 91 50
Telefon: +46/(0)40/13 05 92

UA

Hansgrohe
Ukrainian office
Vasilkovskaya St., 1, office 301
03040 Kiev
Ukraine
Tel./Fax: 0038 (044) 56 85 012

CZ

Hansgrohe
Moravská 85
CZ-619 00 Brno
Telefon: +420/547 212 334
Telefax: +420/547 212 521

SK**EE**

OU Dreesis
Laki 16-407
10621 Tallinn
Estonia
Tel.: 00372 61 29 811
Fax: 00372 65 63 310

H

Hansgrohe Kft.
Forogách utca 11-13
1139 Budapest
Telefon: 0036 /1 236 9090
Telefax: 0036 /1 236 9098

LT

Santosa
Posilaičių 1-28
LT-06115 Vilnius
Tel.: +37(0) 5 2407666
Fax: +37(0) 5 2407666

PRC

上海市松江工业区俞塘路 512 号
天威工业城底层
邮编: 201600
电话: 0086-21-57741239
传真: 0086-21-57741233

SGP

Hans Grohe Pte Ltd
60B Martin Road
#11-03/04 Trade Mart Singapore
SINGAPORE 239067
Tel.: 0065-7322002
Fax: 0065-7320030

UK

Hansgrohe
Units D1 & D2 Sandown Park
Trading Estate Royal Mills
Esher Surrey KT10 8BL
Telephone: 0 13 72 46 56 55
Telefax: 0 13 72 47 06 70

hansgrohe

AXOR | PHÄRO

Hansgrohe · Postfach 1145 · D-77761 Schiltach · Telefon +49 (0) 78 36/51-1282 · Telefax +49 (0) 7836/511440
E-Mail: info@hansgrohe.com · Internet: www.hansgrohe.com